

BLF644P

Broadband power LDMOS transistor

Rev. 2 — 27 June 2014

Product data sheet

1. Product profile

1.1 General description

A 70 W LDMOS RF power transistor for broadcast transmitter, communications and industrial applications. The transistor is suitable for the frequency range HF to 1300 MHz. The excellent ruggedness and broadband performance of this device makes it ideal for digital applications.

Table 1. Typical performance

RF performance at $T_{case} = 25\text{ °C}$ in a common source test circuit.

Test signal	f (MHz)	V _{DS} (V)	P _L (W)	G _p (dB)	η _D (%)	IMD (dBc)
CW, class-A	860	32	100	23	65	-
CW pulsed, class-AB	860	32	100	23.5	66	-
2-tone, class-AB	860	32	45	23	50	-25
	860	32	30	24	40	-35

1.2 Features and benefits

- Integrated ESD protection
- Excellent ruggedness
- High power gain
- High efficiency
- Excellent reliability
- Easy power control
- Compliant to Directive 2002/95/EC, regarding Restriction of Hazardous Substances (RoHS)

1.3 Applications

- Communication transmitter applications in the HF to 1300 MHz frequency range
- Industrial applications in the HF to 1300 MHz frequency range
- Broadcast transmitters



2. Pinning information

Table 2. Pinning

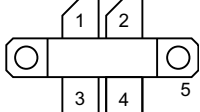
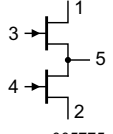
Pin	Description	Simplified outline	Graphic symbol
1	drain1		 aaa-005775
2	drain2		
3	gate1		
4	gate2		
5	source [1]		

[1] Connected to flange.

3. Ordering information

Table 3. Ordering information

Type number	Package		
	Name	Description	Version
BLF644P	-	flanged LDMOST ceramic package; 2 mounting holes; 4 leads	SOT1228A

4. Limiting values

Table 4. Limiting values

In accordance with the Absolute Maximum Rating System (IEC 60134).

Symbol	Parameter	Conditions	Min	Max	Unit
V_{DS}	drain-source voltage		-	65	V
V_{GS}	gate-source voltage		-0.5	+11	V
T_{stg}	storage temperature		-65	+150	°C
T_j	junction temperature [1]		-	225	°C

[1] Continuous use at maximum temperature will affect the reliability, for details refer to the on-line MTF calculator.

5. Thermal characteristics

Table 5. Thermal characteristics

Symbol	Parameter	Conditions	Typ	Unit
$R_{th(j-c)}$	thermal resistance from junction to case	$T_{case} = 80\text{ °C}$; $P_L = 90\text{ W}$ [1]	0.75	K/W

[1] $R_{th(j-c)}$ is measured under RF conditions.

6. Characteristics

Table 6. DC characteristics

$T_j = 25\text{ }^\circ\text{C}$; per section unless otherwise specified.

Symbol	Parameter	Conditions	Min	Typ	Max	Unit
$V_{(BR)DSS}$	drain-source breakdown voltage	$V_{GS} = 0\text{ V}$; $I_D = 0.5\text{ mA}$	65	-	-	V
$V_{GS(th)}$	gate-source threshold voltage	$V_{DS} = 32\text{ V}$; $I_D = 50\text{ mA}$	1.4	1.9	2.4	V
V_{GSq}	gate-source quiescent voltage	$V_{DS} = 32\text{ V}$; $I_{Dq} = 250\text{ mA}$	1.5	2.0	2.5	V
I_{DSS}	drain leakage current	$V_{GS} = 0\text{ V}$; $V_{DS} = 32\text{ V}$	-	-	1.4	μA
I_{DSX}	drain cut-off current	$V_{GS} = V_{GS(th)} + 3.75\text{ V}$; $V_{DS} = 10\text{ V}$	-	9.0	-	A
I_{GSS}	gate leakage current	$V_{GS} = \pm 10\text{ V}$; $V_{DS} = 0\text{ V}$	-	-	140	nA
g_{fs}	forward transconductance	$V_{DS} = 10\text{ V}$; $I_D = 2.5\text{ A}$	-	3.3	-	S
$R_{DS(on)}$	drain-source on-state resistance	$V_{GS} = V_{GS(th)} + 3.75\text{ V}$; $I_D = 1.75\text{ A}$	-	300	-	$\text{m}\Omega$

Table 7. AC characteristics

$T_j = 25\text{ }^\circ\text{C}$; per section unless otherwise specified.

Symbol	Parameter	Conditions	Min	Typ	Max	Unit
C_{iss}	input capacitance	$V_{GS} = 0\text{ V}$; $V_{DS} = 32\text{ V}$; $f = 1\text{ MHz}$	-	39	-	pF
C_{oss}	output capacitance	$V_{GS} = 0\text{ V}$; $V_{DS} = 32\text{ V}$; $f = 1\text{ MHz}$	-	15	-	pF
C_{rs}	feedback capacitance	$V_{GS} = 0\text{ V}$; $V_{DS} = 32\text{ V}$; $f = 1\text{ MHz}$	-	0.84	-	pF

Table 8. RF characteristics

Test signal: CW pulsed, class-AB; $f = 860\text{ MHz}$; RF performance at $V_{DS} = 32\text{ V}$; $I_{Dq} = 200\text{ mA}$;
 $T_{case} = 25\text{ }^\circ\text{C}$; unless otherwise specified; in a class-AB production test circuit.

Symbol	Parameter	Conditions	Min	Typ	Max	Unit
G_p	power gain	$P_L = 100\text{ W}$	22.8	23.5	-	dB
η_D	drain efficiency	$P_L = 100\text{ W}$	62	66	-	%
RL_{in}	input return loss	$P_L = 100\text{ W}$	-	-15	-7	dBc

7. Test information

7.1 Ruggedness in class-AB operation

The BLF644P is capable of withstanding a load mismatch corresponding to $VSWR = 10 : 1$ through all phases under the following conditions: $V_{DS} = 32\text{ V}$; $f = 860\text{ MHz}$ at rated load power.

7.2 Test circuit information

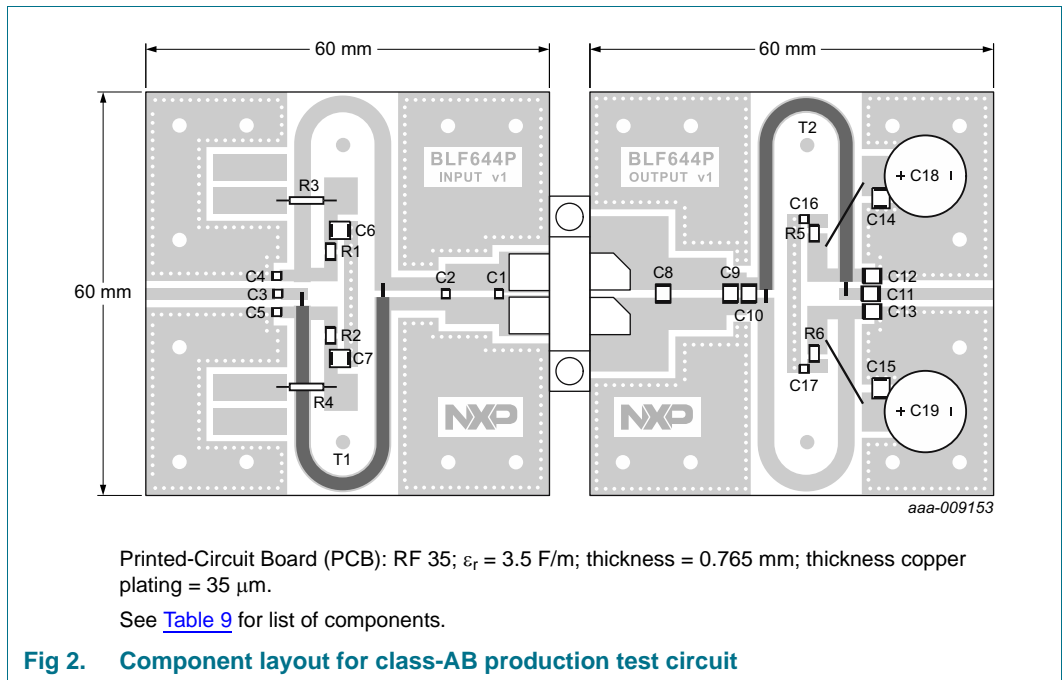
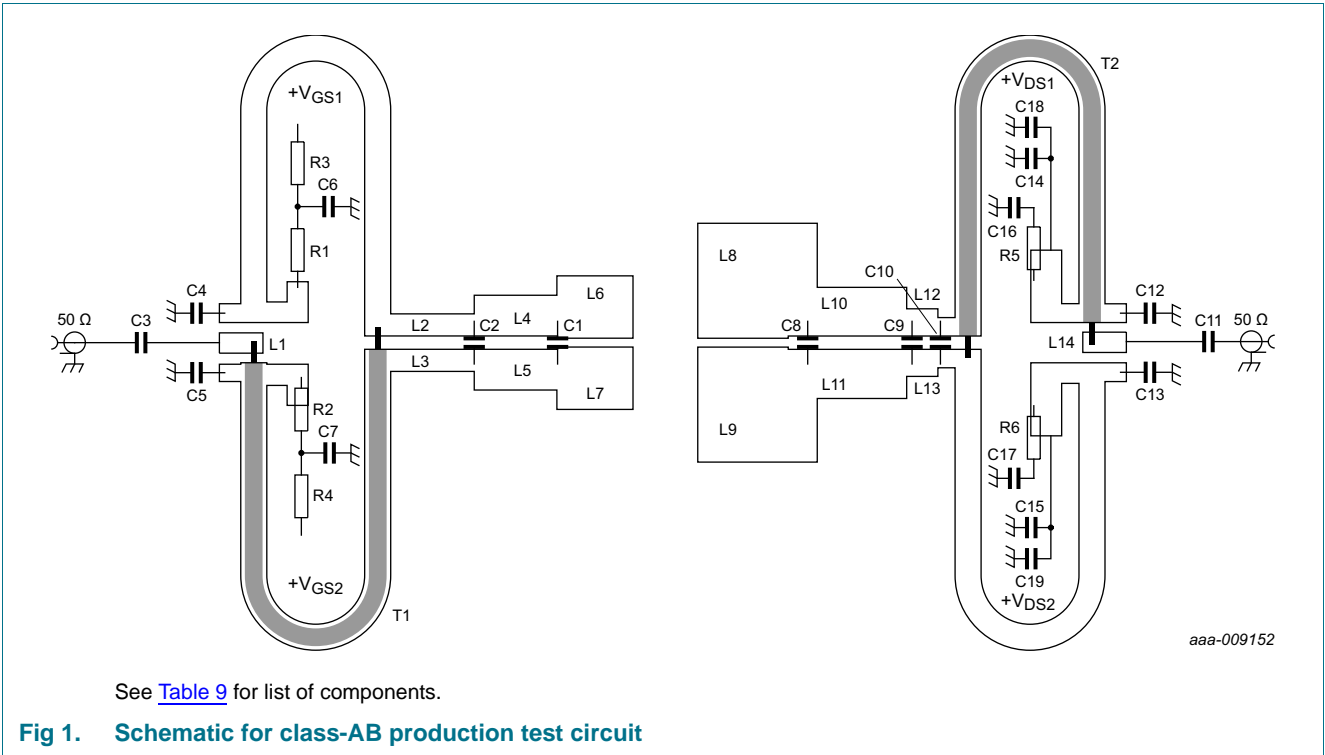

Table 9. List of componentsSee [Figure 1](#) and [Figure 2](#).

Component	Description	Value	Remarks
C1	multilayer ceramic chip capacitor	22 pF [1]	
C2	multilayer ceramic chip capacitor	8.2 pF [1]	
C3	multilayer ceramic chip capacitor	62 pF [1]	
C4, C5	multilayer ceramic chip capacitor	51 pF [1]	
C6, C7, C14, C15	multilayer ceramic chip capacitor	4.7 μ F, 50 V	
C8	multilayer ceramic chip capacitor	12 pF [2]	
C9	multilayer ceramic chip capacitor	5.1 pF [2]	
C10	multilayer ceramic chip capacitor	9.1 pF [2]	
C11	multilayer ceramic chip capacitor	75 pF [2]	
C12, C13	multilayer ceramic chip capacitor	62 pF [2]	
C16, C17	multilayer ceramic chip capacitor	100 pF [1]	
C18, C19	electrolytic capacitor	470 μ F, 63 V	
L1	microstrip	-	(L \times W) 4 mm \times 1.7 mm
L2, L3	microstrip	-	(L \times W) 8 mm \times 2 mm
L4, L5	microstrip	-	(L \times W) 8 mm \times 4 mm
L6, L7	microstrip	-	(L \times W) 7.4 mm \times 6 mm
L8, L9	microstrip	-	(L \times W) 11.1 mm \times 11.6 mm
L10, L11	microstrip	-	(L \times W) 8.6 mm \times 4.9 mm
L12, L13	microstrip	-	(L \times W) 3 mm \times 2.7 mm
L14	microstrip	-	(L \times W) 4 mm \times 1.7 mm
R1, R2	multilayer ceramic chip capacitor	5.6 Ω	SMD 1206
R3, R4	multilayer ceramic chip capacitor	100 Ω	
R5, R6	multilayer ceramic chip capacitor	30 Ω	SMD 1206
T1, T2	Semi-rigid coaxial cable	25 Ω , 61 mm	UT-90C-25

[1] American Technical Ceramics type 800A or capacitor of same quality.

[2] American Technical Ceramics type 800B or capacitor of same quality.

7.3 Graphical data

7.3.1 1-Tone CW

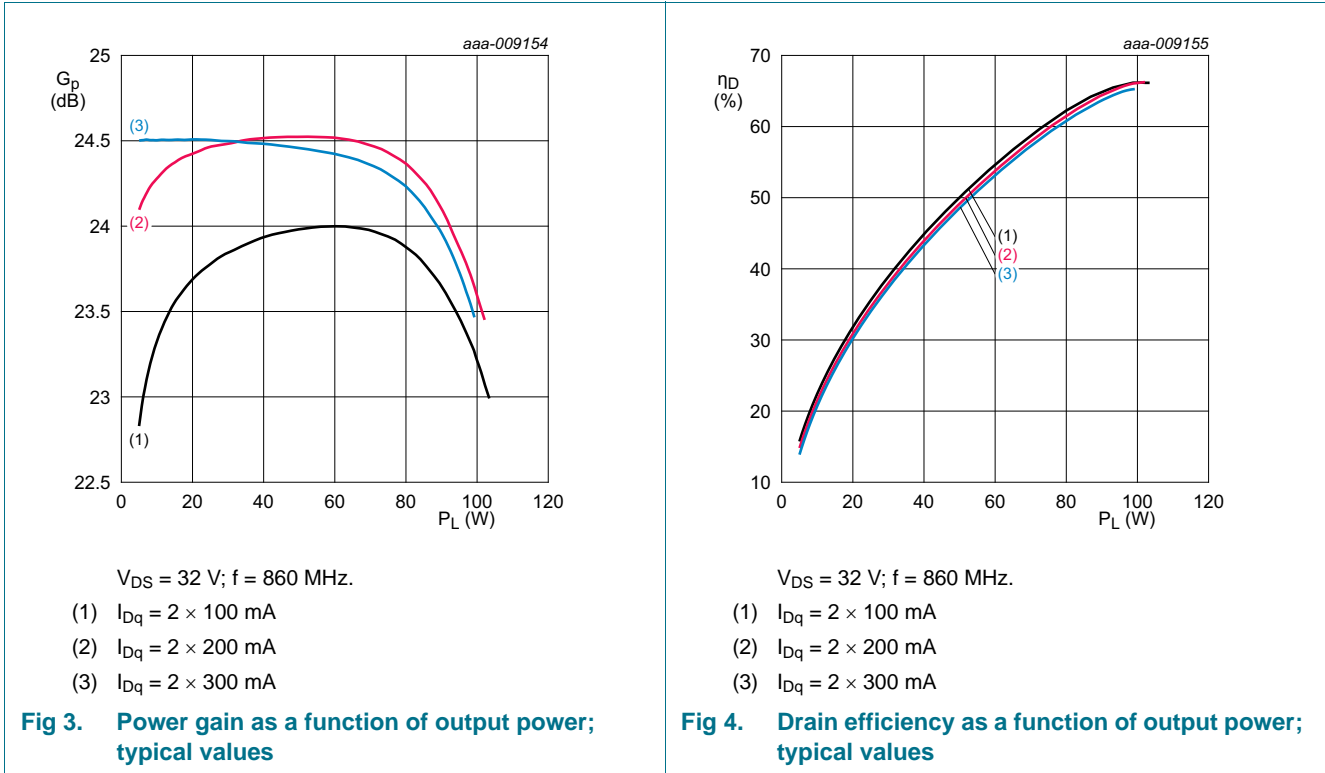

7.3.2 1-Tone pulsed

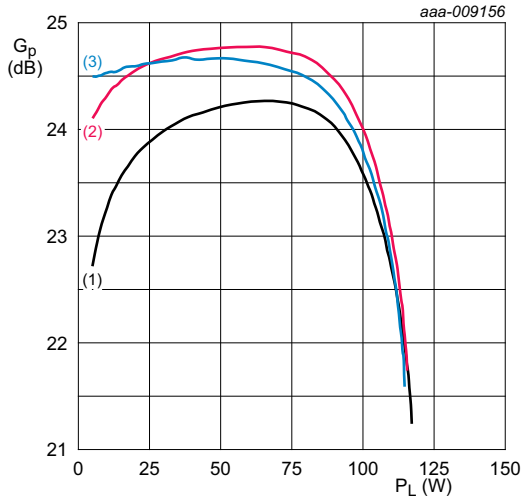

$V_{DS} = 32\text{ V}; f = 860\text{ MHz}; \delta = 20\%; t_p = 100\ \mu\text{s}.$
 (1) $I_{Dq} = 2 \times 100\text{ mA}$
 (2) $I_{Dq} = 2 \times 200\text{ mA}$
 (3) $I_{Dq} = 2 \times 300\text{ mA}$

Fig 5. Power gain as a function of output power; typical values

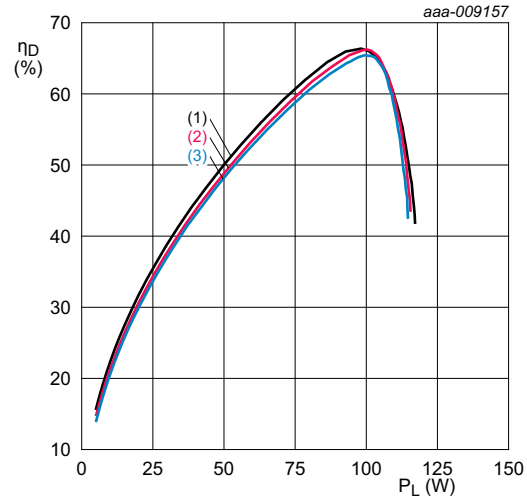

$V_{DS} = 32\text{ V}; f = 860\text{ MHz}; \delta = 20\%; t_p = 100\ \mu\text{s}.$
 (1) $I_{Dq} = 2 \times 100\text{ mA}$
 (2) $I_{Dq} = 2 \times 200\text{ mA}$
 (3) $I_{Dq} = 2 \times 300\text{ mA}$

Fig 6. Drain efficiency as a function of output power; typical values

7.3.3 2-Tone CW

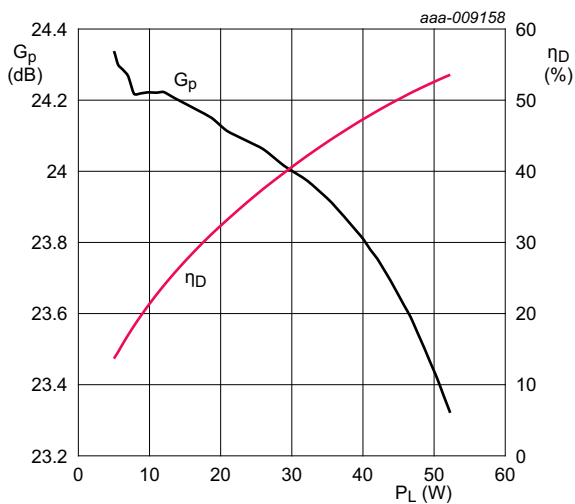

$V_{DS} = 32\text{ V}; I_{Dq} = 2 \times 350\text{ mA}; f_1 = 889.95\text{ MHz}; f_2 = 890.05\text{ MHz}.$

Fig 7. Power gain and drain efficiency as function of output power; typical values

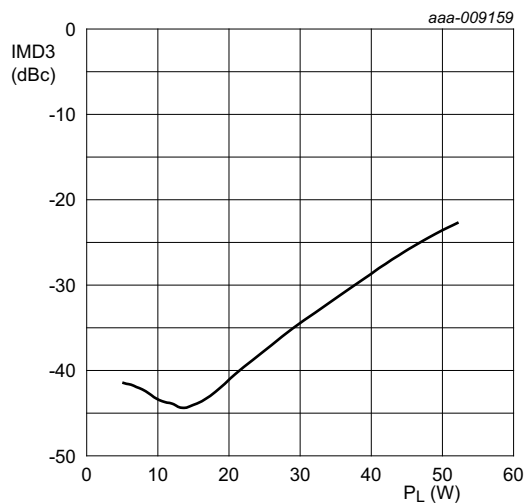

$V_{DS} = 32\text{ V}; I_{Dq} = 2 \times 350\text{ mA}; f_1 = 889.95\text{ MHz}; f_2 = 890.05\text{ MHz}.$

Fig 8. Third order modulation distortion as a function of output power; typical values

8. Package outline

Flanged LDMOST ceramic package; 2 mounting holes; 4 leads

SOT1228A

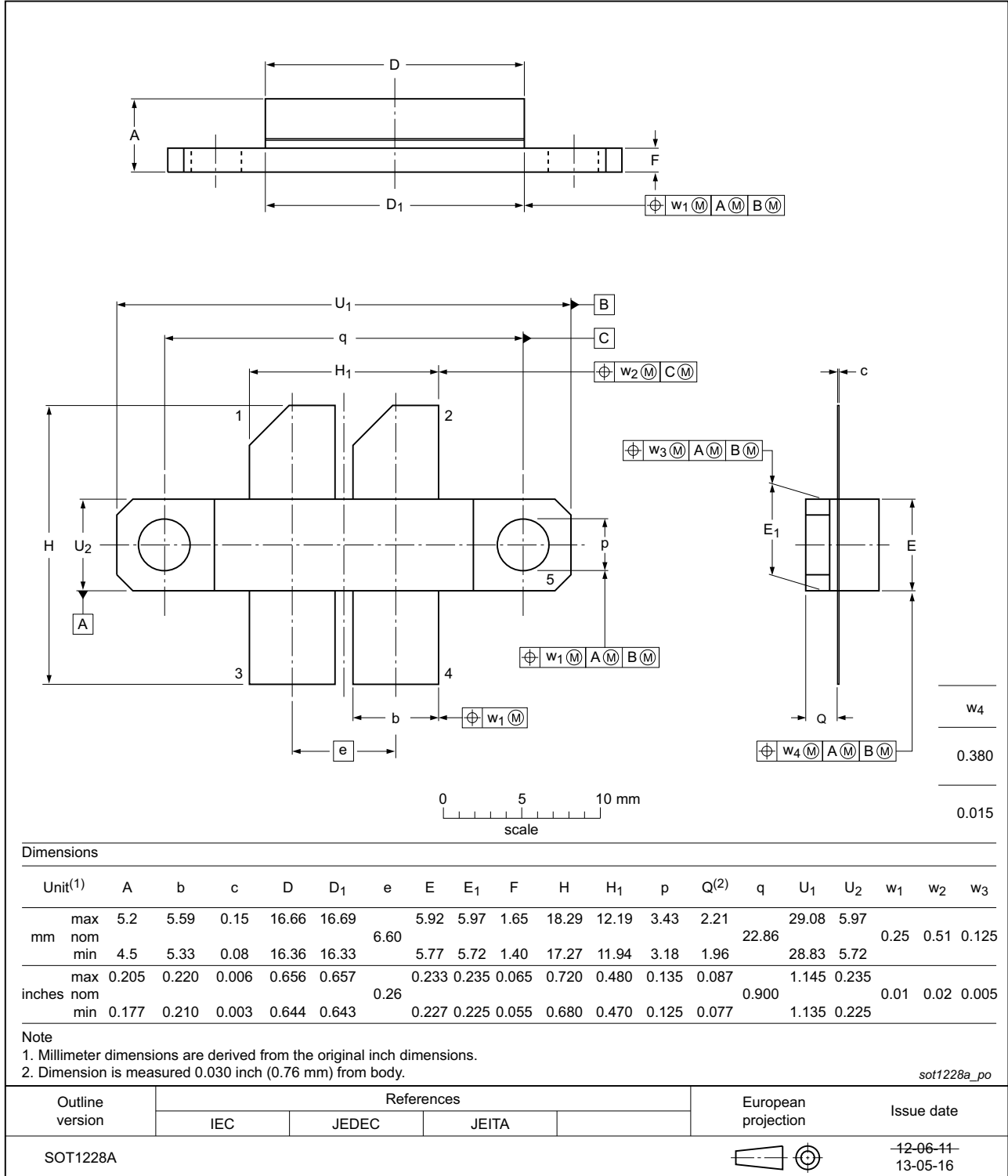

Fig 9. Package outline SOT1228A

9. Handling information

CAUTION



This device is sensitive to ElectroStatic Discharge (ESD). Observe precautions for handling electrostatic sensitive devices.

Such precautions are described in the *ANSI/ESD S20.20*, *IEC/ST 61340-5*, *JESD625-A* or equivalent standards.

10. Abbreviations

Table 10. Abbreviations

Acronym	Description
CW	Continuous Wave
ESD	ElectroStatic Discharge
HF	High Frequency
LDMOS	Laterally Diffused Metal Oxide Semiconductor
LDMOST	Laterally Diffused Metal Oxide Semiconductor Transistor
MTF	Median Time to Failure
SMD	Surface Mounted Device
VSWR	Voltage Standing-Wave Ratio

11. Revision history

Table 11. Revision history

Document ID	Release date	Data sheet status	Change notice	Supersedes
BLF644P v.2	20140627	Product data sheet	-	BLF644P v.1
Modifications	<ul style="list-style-type: none"> • Section 1.1 on page 1: added 'communications' to the description • Section 1.2 on page 1: added bullet 'broadcast transmitters' • Table 1 on page 1: table has been updated • Table 4 on page 2: table has been updated • Table 5 on page 2: value $R_{th(j-c)}$ set to 0.75 (K/W) • Table 6 on page 3: table has been updated • Table 8 on page 3: table has been updated • Section 7.1 on page 3: value frequency changed from 1300 MHz to 860 MHz • Section 7.2 on page 4: section has been added • Section 7.3 on page 6: section has been added 			
BLF644P v.1	20130611	Objective data sheet	-	-

12. Legal information

12.1 Data sheet status

Document status ^{[1][2]}	Product status ^[3]	Definition
Objective [short] data sheet	Development	This document contains data from the objective specification for product development.
Preliminary [short] data sheet	Qualification	This document contains data from the preliminary specification.
Product [short] data sheet	Production	This document contains the product specification.

[1] Please consult the most recently issued document before initiating or completing a design.

[2] The term 'short data sheet' is explained in section "Definitions".

[3] The product status of device(s) described in this document may have changed since this document was published and may differ in case of multiple devices. The latest product status information is available on the Internet at URL <http://www.nxp.com>.

12.2 Definitions

Draft — The document is a draft version only. The content is still under internal review and subject to formal approval, which may result in modifications or additions. NXP Semiconductors does not give any representations or warranties as to the accuracy or completeness of information included herein and shall have no liability for the consequences of use of such information.

Short data sheet — A short data sheet is an extract from a full data sheet with the same product type number(s) and title. A short data sheet is intended for quick reference only and should not be relied upon to contain detailed and full information. For detailed and full information see the relevant full data sheet, which is available on request via the local NXP Semiconductors sales office. In case of any inconsistency or conflict with the short data sheet, the full data sheet shall prevail.

Product specification — The information and data provided in a Product data sheet shall define the specification of the product as agreed between NXP Semiconductors and its customer, unless NXP Semiconductors and customer have explicitly agreed otherwise in writing. In no event however, shall an agreement be valid in which the NXP Semiconductors product is deemed to offer functions and qualities beyond those described in the Product data sheet.

12.3 Disclaimers

Limited warranty and liability — Information in this document is believed to be accurate and reliable. However, NXP Semiconductors does not give any representations or warranties, expressed or implied, as to the accuracy or completeness of such information and shall have no liability for the consequences of use of such information. NXP Semiconductors takes no responsibility for the content in this document if provided by an information source outside of NXP Semiconductors.

In no event shall NXP Semiconductors be liable for any indirect, incidental, punitive, special or consequential damages (including - without limitation - lost profits, lost savings, business interruption, costs related to the removal or replacement of any products or rework charges) whether or not such damages are based on tort (including negligence), warranty, breach of contract or any other legal theory.

Notwithstanding any damages that customer might incur for any reason whatsoever, NXP Semiconductors' aggregate and cumulative liability towards customer for the products described herein shall be limited in accordance with the *Terms and conditions of commercial sale* of NXP Semiconductors.

Right to make changes — NXP Semiconductors reserves the right to make changes to information published in this document, including without limitation specifications and product descriptions, at any time and without notice. This document supersedes and replaces all information supplied prior to the publication hereof.

Suitability for use — NXP Semiconductors products are not designed, authorized or warranted to be suitable for use in life support, life-critical or safety-critical systems or equipment, nor in applications where failure or malfunction of an NXP Semiconductors product can reasonably be expected to result in personal injury, death or severe property or environmental damage. NXP Semiconductors and its suppliers accept no liability for inclusion and/or use of NXP Semiconductors products in such equipment or applications and therefore such inclusion and/or use is at the customer's own risk.

Applications — Applications that are described herein for any of these products are for illustrative purposes only. NXP Semiconductors makes no representation or warranty that such applications will be suitable for the specified use without further testing or modification.

Customers are responsible for the design and operation of their applications and products using NXP Semiconductors products, and NXP Semiconductors accepts no liability for any assistance with applications or customer product design. It is customer's sole responsibility to determine whether the NXP Semiconductors product is suitable and fit for the customer's applications and products planned, as well as for the planned application and use of customer's third party customer(s). Customers should provide appropriate design and operating safeguards to minimize the risks associated with their applications and products.

NXP Semiconductors does not accept any liability related to any default, damage, costs or problem which is based on any weakness or default in the customer's applications or products, or the application or use by customer's third party customer(s). Customer is responsible for doing all necessary testing for the customer's applications and products using NXP Semiconductors products in order to avoid a default of the applications and the products or of the application or use by customer's third party customer(s). NXP does not accept any liability in this respect.

Limiting values — Stress above one or more limiting values (as defined in the Absolute Maximum Ratings System of IEC 60134) will cause permanent damage to the device. Limiting values are stress ratings only and (proper) operation of the device at these or any other conditions above those given in the Recommended operating conditions section (if present) or the Characteristics sections of this document is not warranted. Constant or repeated exposure to limiting values will permanently and irreversibly affect the quality and reliability of the device.

Terms and conditions of commercial sale — NXP Semiconductors products are sold subject to the general terms and conditions of commercial sale, as published at <http://www.nxp.com/profile/terms>, unless otherwise agreed in a valid written individual agreement. In case an individual agreement is concluded only the terms and conditions of the respective agreement shall apply. NXP Semiconductors hereby expressly objects to applying the customer's general terms and conditions with regard to the purchase of NXP Semiconductors products by customer.

No offer to sell or license — Nothing in this document may be interpreted or construed as an offer to sell products that is open for acceptance or the grant, conveyance or implication of any license under any copyrights, patents or other industrial or intellectual property rights.

Export control — This document as well as the item(s) described herein may be subject to export control regulations. Export might require a prior authorization from competent authorities.

Non-automotive qualified products — Unless this data sheet expressly states that this specific NXP Semiconductors product is automotive qualified, the product is not suitable for automotive use. It is neither qualified nor tested in accordance with automotive testing or application requirements. NXP Semiconductors accepts no liability for inclusion and/or use of non-automotive qualified products in automotive equipment or applications.

In the event that customer uses the product for design-in and use in automotive applications to automotive specifications and standards, customer (a) shall use the product without NXP Semiconductors' warranty of the product for such automotive applications, use and specifications, and (b) whenever customer uses the product for automotive applications beyond

NXP Semiconductors' specifications such use shall be solely at customer's own risk, and (c) customer fully indemnifies NXP Semiconductors for any liability, damages or failed product claims resulting from customer design and use of the product for automotive applications beyond NXP Semiconductors' standard warranty and NXP Semiconductors' product specifications.

Translations — A non-English (translated) version of a document is for reference only. The English version shall prevail in case of any discrepancy between the translated and English versions.

12.4 Trademarks

Notice: All referenced brands, product names, service names and trademarks are the property of their respective owners.

13. Contact information

For more information, please visit: <http://www.nxp.com>

For sales office addresses, please send an email to: salesaddresses@nxp.com

14. Contents

1	Product profile	1
1.1	General description	1
1.2	Features and benefits	1
1.3	Applications	1
2	Pinning information	2
3	Ordering information	2
4	Limiting values	2
5	Thermal characteristics	2
6	Characteristics	3
7	Test information	3
7.1	Ruggedness in class-AB operation	3
7.2	Test circuit information	4
7.3	Graphical data	6
7.3.1	1-Tone CW	6
7.3.2	1-Tone pulsed	7
7.3.3	2-Tone CW	7
8	Package outline	8
9	Handling information	9
10	Abbreviations	9
11	Revision history	9
12	Legal information	10
12.1	Data sheet status	10
12.2	Definitions	10
12.3	Disclaimers	10
12.4	Trademarks	11
13	Contact information	11
14	Contents	12

Please be aware that important notices concerning this document and the product(s) described herein, have been included in section 'Legal information'.

© NXP Semiconductors N.V. 2014.

All rights reserved.

For more information, please visit: <http://www.nxp.com>

For sales office addresses, please send an email to: salesaddresses@nxp.com

Date of release: 27 June 2014

Document identifier: BLF644P