

CFRA201-G Thru. CFRA207-G

Reverse Voltage: 50 to 1000 Volts

Forward Current: 2.0 Amp

RoHS Device

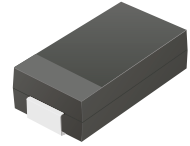

Features

- Fast switching for high efficiency.
- Diffused junction.
- Low reverse leakage current.
- Low forward voltage drop.
- High current capability.
- The plastic material carries UL recognition 94V-0

Mechanical data

- Case: JEDEC DO-214AC, molded plastic.
- Terminals: solderable per MIL-STD-750, method 2026.
- Polarity: Color band denotes cathode end.
- Approx. weight: 0.053 grams

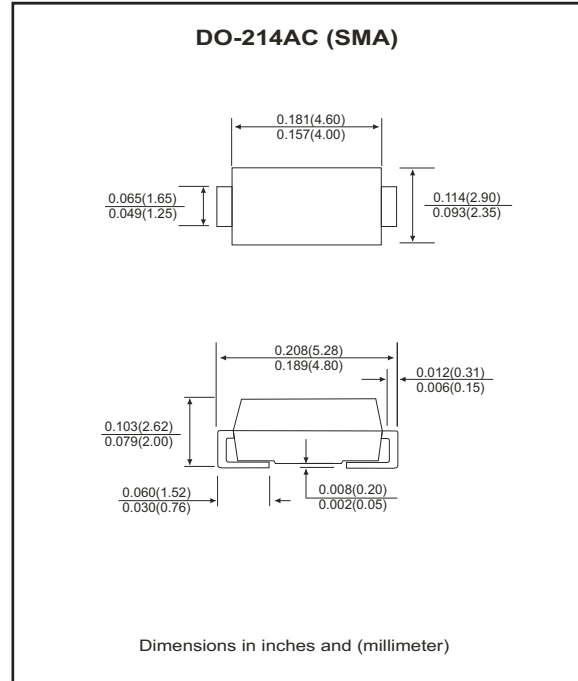

Circuit diagram



Maximum Ratings and Electrical Characteristics

Rating at 25°C ambient temperature unless otherwise specified.
Single phase, half wave, 60Hz, resistive or inductive load.
For capacitive load, derate current by 20%

Parameter	Symbol	CFRA 201-G	CFRA 202-G	CFRA 203-G	CFRA 204-G	CFRA 205-G	CFRA 206-G	CFRA 207-G	Units
Max. Repetitive peak reverse voltage	V_{RRM}	50	100	200	400	600	800	1000	V
Max. DC blocking voltage	V_{DC}	50	100	200	400	600	800	1000	V
Max. RMS voltage	V_{RMS}	35	70	140	280	420	560	700	V
Peak surge forward current, 8.3ms single half sine-wave superimposed on rate load (JEDEC method)	I_{FSM}	30							A
Max. Average forward current	I_o	2.0							A
Max. Peak forward voltage at 2.0A DC	V_F	1.3							V
Max. DC reverse current at $T_J=25^\circ\text{C}$ rated DC blocking voltage $T_J=100^\circ\text{C}$	I_R	5.0 100							μA
Max. Reverse recovery time (Note1)	T_{rr}	150			250		500		nS
Typical junction capacitance (Note2)	C_J	30			20				pF
Typical thermal resistance (Note 3)	$R_{\theta JA}$	25							$^\circ\text{C/W}$
Operating junction temperature	T_J	150							$^\circ\text{C}$
Storage temperature	T_{STG}	-55 to +150							$^\circ\text{C}$

Notes: 1. Measured with $I_F=0.5\text{A}, I_R=1\text{A}, I_{RR}=0.25\text{A}$
2. Measured at 1.0 MHz and applied reverse voltage of 4.0V DC
3. Thermal resistance junction to ambient.

RATING AND CHARACTERISTIC CURVES (CFRA201-G thru CFRA207-G)

Fig.1- Forward current derating curve

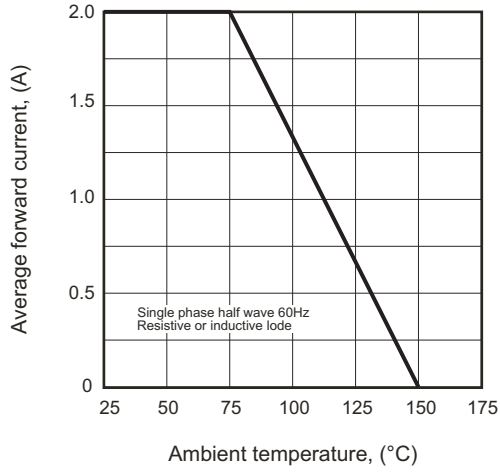

Fig.2- Maximum Non-repetitive Surge Current

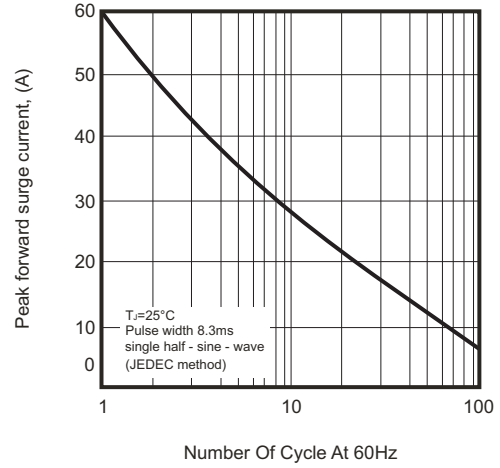

Fig.3- Typical junction capacitance

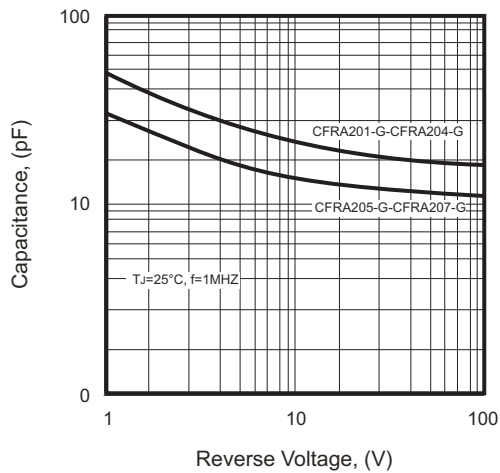
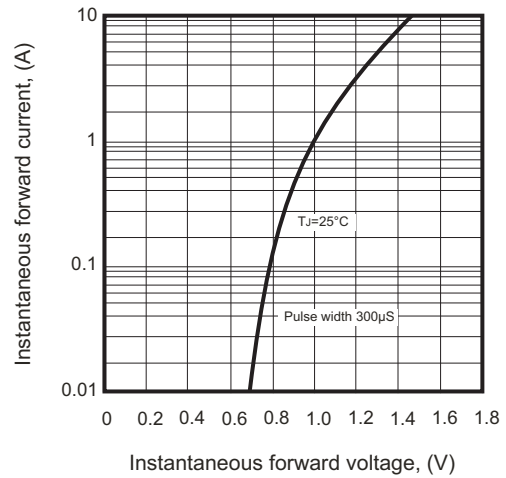
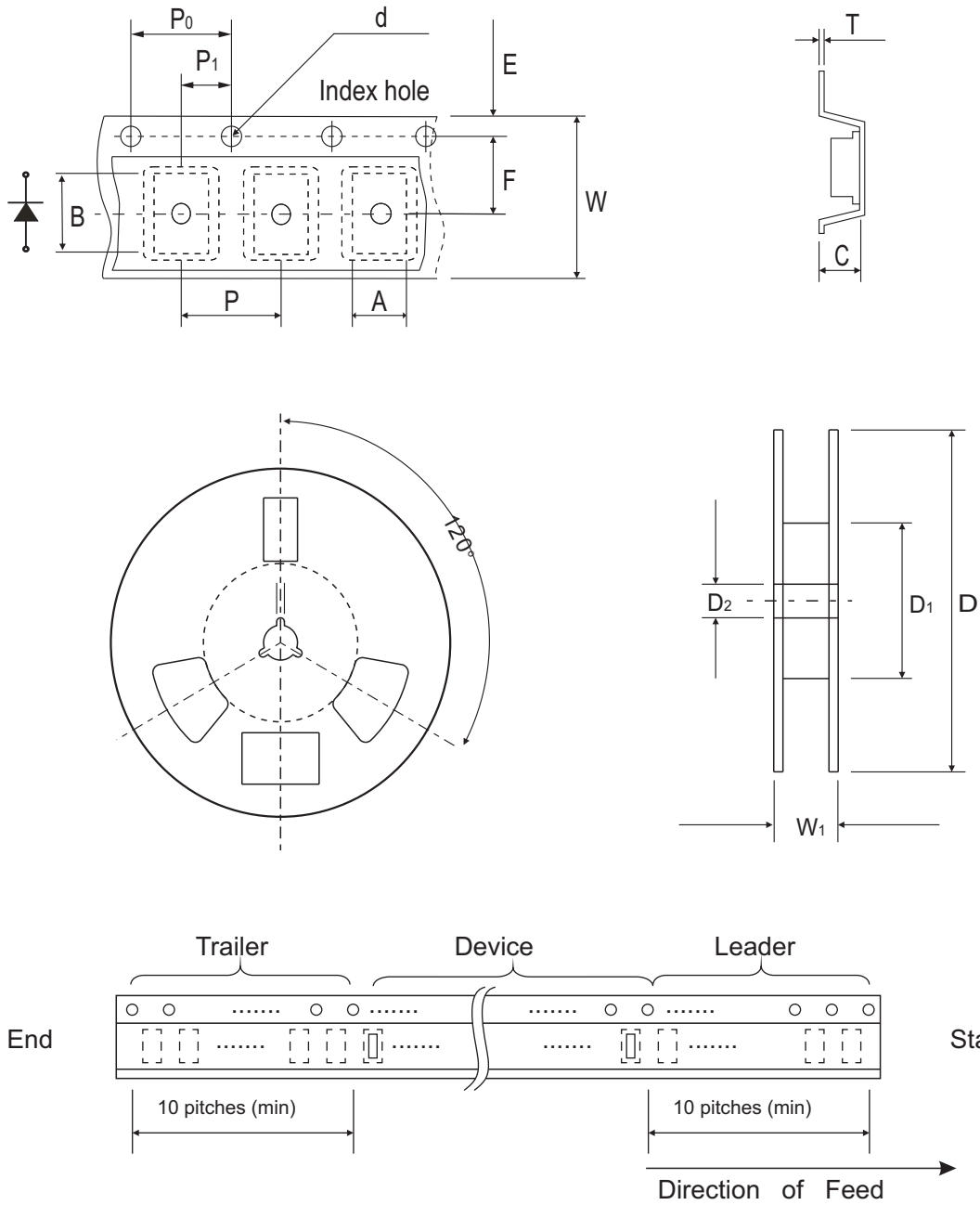

Fig.4- Typical forward characteristics



Reel Taping Specification



DO-214AC (SMA)	SYMBOL	A	B	C	d	D	D1	D2
	(mm)	2.72 ± 0.10	5.25 ± 0.10	2.36 ± 0.10	1.55 ± 0.05	330 ± 2.00	50.0 MIN.	13.00 ± 0.20
	(inch)	0.107 ± 0.004	0.207 ± 0.004	0.093 ± 0.004	0.061 ± 0.002	12.99 ± 0.079	1.969 MIN.	0.512 ± 0.008

DO-214AC (SMA)	SYMBOL	E	F	P	P0	P1	T	W	W1
	(mm)	1.75 ± 0.10	5.50 ± 0.05	4.00 ± 0.10	4.00 ± 0.10	2.00 ± 0.05	0.30 ± 0.010	12.0 ± 0.30	12.4+2.00/-0.00
	(inch)	0.069 ± 0.004	0.217 ± 0.002	0.157 ± 0.004	0.157 ± 0.004	0.079 ± 0.002	0.012 ± 0.004	0.472 ± 0.012	0.488 + 0.079/-0

Marking Code

Part Number	Marking Code
CFRA201-G	RS2AA
CFRA202-G	RS2BA
CFRA203-G	RS2DA
CFRA204-G	RS2JA
CFRA205-G	RS2MA



xxxxx= Product type marking code

Suggested PAD Layout

SIZE	DO-214AC (SMA)	
	(mm)	(inch)
A	4.00	0.157
B	1.70	0.067
C	1.80	0.071
D	6.00	0.236
E	2.30	0.091

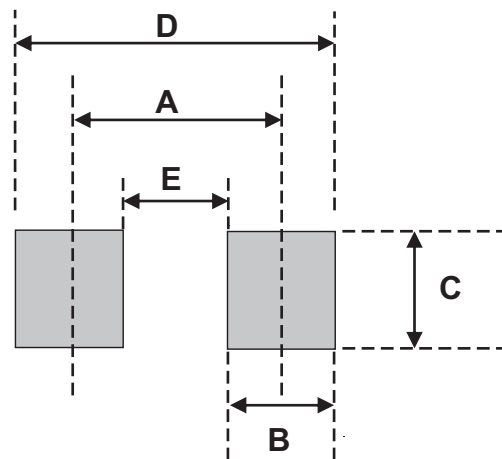

Standard Packaging

Case Type	Qty Per Reel	Reel Size
	(Pcs)	(inch)
DO-214AC (SMA)	5,000	13