



EVAL6520-1421

14 W / 21 W T5 miniature ballast driven by L6520
and STT13005D bipolar transistors

Data brief

Features

- Drives either T5-14W-HE or T5-21W-HE lamps
- Standard form factor (19 mm x 120 mm)
- Compliance with IEC61347-2-3, IEC61000-2-3 and EN55022 Class-C

Description

The EVAL6520-1421 is a demonstration board able to drive either a 14 W or 21 W linear T5 fluorescent lamp with the L6520 low voltage ballast controller.

The half bridge consists of NPN high voltage power transistors driven by a suitable pulse transformer.

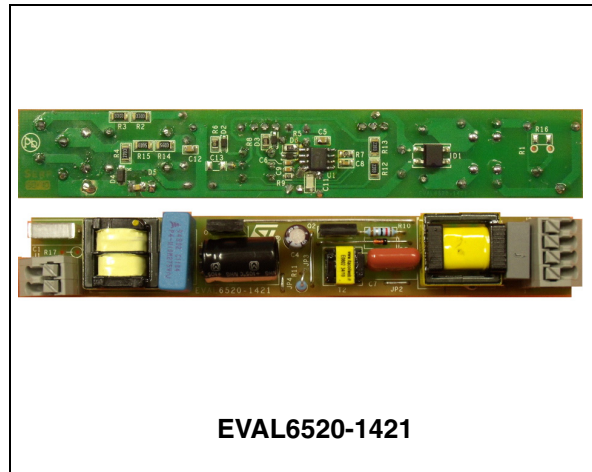

Contents

1	Introduction	3
2	Board description	4
3	Board performance	7
4	Application specifications	9
5	Bill of material and board schematics	10
	5.1 Board schematic	12
	Appendix A Magnetic components data.	13
	Revision history	15

1 Introduction

The L6520 low voltage ballast controller is intended to drive extremely compact applications based on either MOSFETs or bipolar transistors.

The EVAL6520-1421 is capable of driving either a T5-14W-HE or T5-21W-HE lamp, with the same miniaturized (16 mm wide) ballast.

The selection of both the resonant components and the bipolar transistors, together with the design of the suitable pulse transformer, and IC power supply is also described.

2 Board description

The board is supplied by any AC voltage in the European mains range and does not need any power factor correction having an input power of less than 25 W.

The half bridge voltage is obtained by filtering the rectified input voltage. This allows the use of a cheaper bulk capacitor and bipolar transistors.

The selection of a target condition is required by the range of the input voltage together with the necessity to drive two different kinds of lamps. In particular, the best driving condition and the best efficiency is obtained at 240 Vac with a 14 W lamp connected.

An EMI filter is placed at the board's input to meet IEC61000 standards.

The lamp's cathodes are current preheated to make the ballast choke more compact thanks to the absence of auxiliary windings.

The resonant network design starts from the selection of the resonant capacitor (C10) that corresponds to the desired ballast efficiency. The inductance (L1) can be obtained by the following equation:

Equation 1

$$V_{\text{Lamp}} = \left| \frac{\frac{1}{R_{\text{Lamp}}}}{\frac{1}{R_{\text{Lamp}}} + j\omega C_{\text{RES}}} \cdot \frac{V_{\text{HB}}}{j\omega L_{\text{RES}} + \frac{1}{\frac{1}{R_{\text{Lamp}}} + j\omega C_{\text{RES}}}} \right|$$

V_{HB} is the effective voltage obtained across the half bridge along one mains cycle. The lower voltage is obtained at 50 Hz and can be approximately computed as:

Equation 2

$$V_{\text{HB}} = \left(\frac{\sqrt{2}}{2} \cdot V_{\text{IN}} - V_{\text{F}} \right) + \sqrt{\left(\frac{\sqrt{2}}{2} \cdot V_{\text{IN}} - V_{\text{F}} \right)^2 - \frac{1.54 \cdot 10^5 \cdot P_{\text{LAMP}}}{f_{\text{MAINS}} \cdot C_{\text{OUT}}}}$$

where:

- V_{F} is the forward voltage drop of the rectifier bridge (1 V typ.)
- V_{IN} is the RMS value of the input voltage
- C_{OUT} is the value of the bulk capacitor in μF (In this case $C3 = 4.7 \mu\text{F}$ has been selected)

A resonant capacitor equal to 3.9 nF has been selected and resonant inductor equal to 3 mH has been calculated.

It is now possible to estimate the ignition frequency, which must be higher than 46 kHz (minimum programmable value), and the minimum preheating frequency that guarantees a preheating voltage higher than 130 Vrms, as required by the lamp specifications.

Equation 3

$$V_{PH-IGN} = \left| \frac{\frac{V_{PFC} \cdot \sqrt{2}}{\pi} \cdot \frac{1}{j\omega C_{RES}}}{\frac{1}{j\omega C_{RES}} + j\omega L_{RES}} \right|$$

A preheating frequency equal to 70 kHz has been selected by connecting a 2.49 kΩ resistor (R5) between the FPRES pin and GND.

The half bridge is based on two STT13005D power bipolar transistors (Q1 and Q2). Both the high side and low side transistor are driven by a pulse transformer (T2).

To design this pulse transformer, the following parameters must be taken into account:

- Maximum available spacing on the PCB: this determines the core dimension.
- Maximum magnetizing current ($I_{mag,rms}$) on the primary side of the transformer: this current causes core losses to not be transferred as a useful signal on the secondary side of the transformer. To minimize it, a higher primary inductance should be adopted. Typical inductances are between 6 mH and 40 mH, depending on the core dimension and the core permeability.
- Primary to secondary transfer ratio (n): the output voltage of a step-down transformer is lower than the input voltage, whereas the output current is higher than the input current. This helps to obtain higher DC currents with lower IC power dissipation. The minimum $V_{be}(sat)$ must be guaranteed in any condition as well as the minimum I_B that guarantees the saturation condition of the BJT.

The $I_{mag,rms(MAX)}$ is selected lower than 10 mA when V_{cc} is equal to 13 V and a typical storage time of 1.2 μs is considered, therefore the primary inductance must be:

Equation 4

$$L_{pri} \geq V_{cc} \cdot \frac{T_{on,max}}{I_{mag,rms}} = \sqrt{3} \cdot V_{cc} \frac{\frac{1}{2 \cdot f_{run}} - T_{dt} - T_{sto} - 200ns}{I_{mag,rms}} = 1.732 \cdot V_{cc} \frac{9.42\mu s - T_{sto}}{I_{mag,rms}} = 6.18mH$$

The V_{be} of the bipolar transistor can be calculated as follows (see [Figure 2](#)):

Equation 5

$$V_{be} = V_{pri} \cdot n - I_b \cdot R_b = \left[V_{cc} - \frac{I_b}{n} \cdot (R_{ds,on_h} + R_{pri} + R_{ds,on_l}) \right] \cdot n - I_b \cdot R_b$$

The R_{ds,on_h} and the R_{ds,on_l} are the ON resistances of the L6520 drivers and can be considered equal to 10 Ω each.

I_b is equal to I_c/h_{fe} , and can be considered equal to $I_c/6$. I_b times R_b can be set between 0.7 V and 1 V, during run mode: in this design R_b (R6 and R8) can be selected between 10 Ω and 13 Ω.

With these constraints the following is obtained:

Equation 6

$$V_{be} = \left[13 - \frac{0.46}{n} \cdot (20 + R_{pri}) \right] \cdot n - 0.76 = 13 \cdot n - 9.2 - 0.46 \cdot R_{pri} - 0.76 > 1.1 \rightarrow 13 \cdot n - 0.46 \cdot R_{pri} > 11.6$$

Selecting an R_{pri} (R7) equal to 47 Ω , the minimum transfer ratio should be equal to 2.55.

$n = 5.6$ has been selected.

The PWM_det pin network is composed of 3x220 k Ω resistors (R11 to R13) together with a 47 pF speed-up capacitor (C11). The value of the speed-up capacitor also avoids a misdetection of the hard switching.

During normal operation the IC absorbs the following currents from the Vcc:

1. Effective base currents of the BJTs divided by n (5.6). A 39 mA_(MAX) is estimated.
2. Magnetizing current = 10 mA_(MAX)
3. L6520 power consumption: 8 mA_(MAX)

A maximum current of 57 mA_{rms} must be foreseen. For this reason, the IC power supply has been connected in series with the resonant network (D4 and D5). This connection does not interfere with the optimum preheating of the lamp's cathodes, but introduces a little offset (7.5 V typ.) into the lamp voltage.

This offset affects the EOL detection, but a different choice of values of the Zener diodes (D6 and D7) makes the detection symmetrical. The two values, together with the resistance values (R14 and R15), can be calculated through the following system of equations ($V_{Lamp,MAX} = 30$ V and $V_{Lamp,min} = -16$ V):

Equation 7

$$\begin{cases} V_{Lamp,MAX} = V_{EOL} + V_{Z,D7} + I_{BIAS} \cdot (R14 + R15) + V_{F,D6} \\ V_{Lamp,min} = V_{EOL} - V_{Z,D6} - I_{BIAS} \cdot (R14 + R15) - V_{F,D7} \end{cases}$$

Finally, a 4.7 μ F is used as the Vcc bulk capacitor (C4) and two 100 nF ceramic capacitors (C5) are placed close to the Vcc pins of the two ICs.

By allowing the startup network (R2 to R4) to pass through the upper cathode of the lamp, the automatic re-lamp feature is easily obtained.

3 Board performance

Figure 1. EMI spectrum at nominal input voltage (230 Vac)

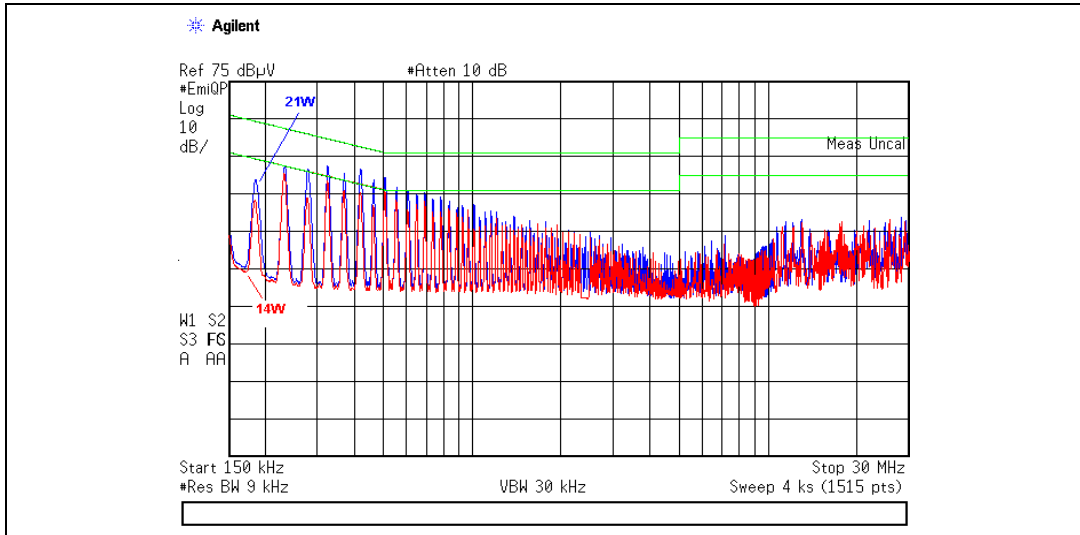

Figure 2. Lamp voltage and current (T5 14 W HE)

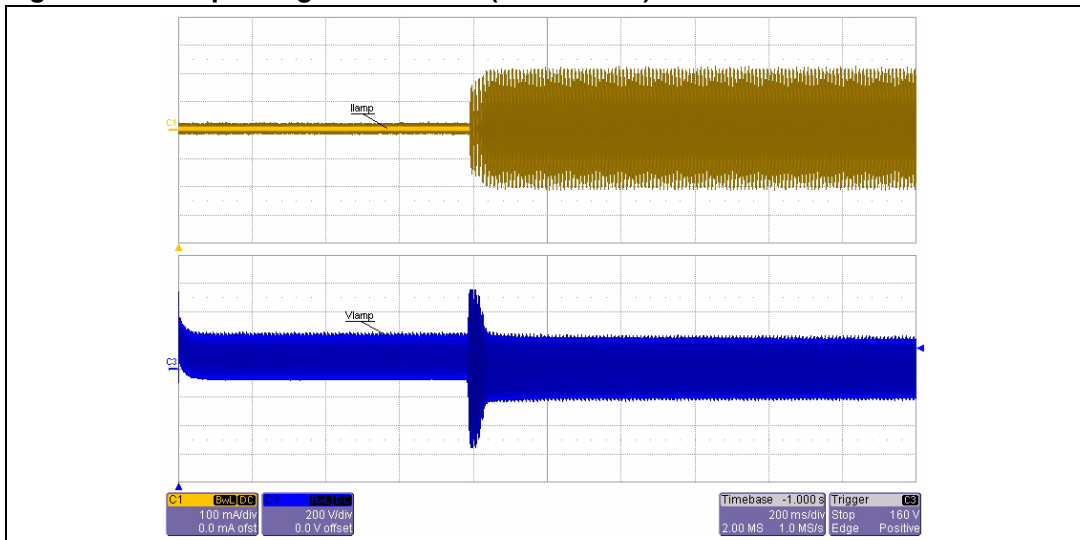
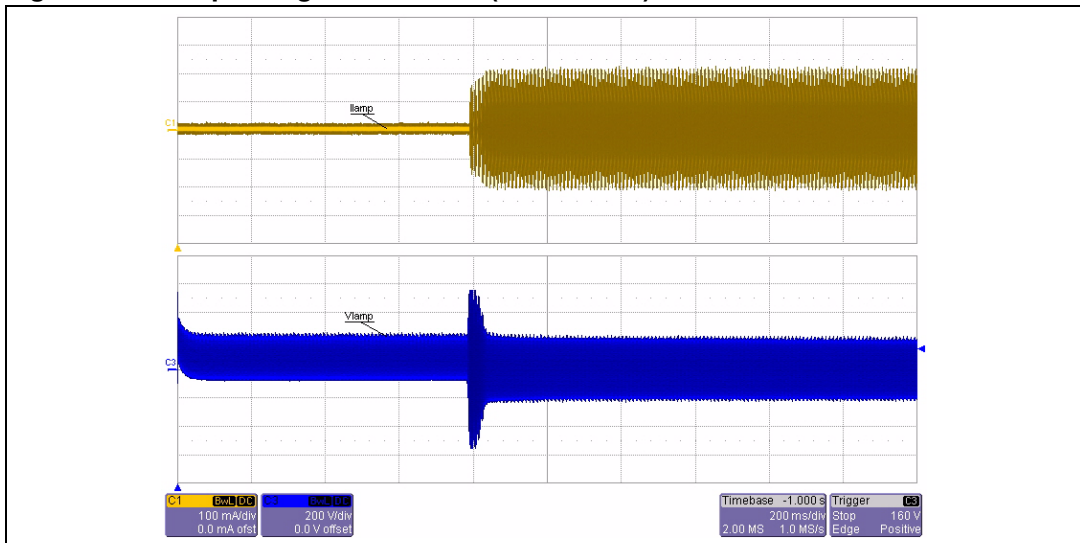

Figure 3. Lamp voltage and current (T5 21 W HE)



4 Application specifications

[Table 1](#) and [Table 2](#) show the application specifications for the input and lamp requirements.

Table 1. Input requirements

Parameter	Value	Unit
Input voltage	198 to 264	V _{rms}
Mains freq.	50 to 60	Hz
Input power	25	W max

Table 2. Lamp requirements

Parameter	T5 - 14 W	T5 - 21 W	Unit
Lamp current	170 ± 30%		mA _{rms}
Lamp voltage	82 ± 6%	123 ± 6%	V _{rms}
Max. ignition voltage	1000		V _{pk}
Max. preheating voltage	130		V _{rms}

5 Bill of material and board schematics

Table 3. Bill of material

Reference	Value / part number	Rating	Notes
C1	100 nF	275 Vac	
C2	100 nF	275 Vac	
C3	4.7 μ F	400 Vdc - 105 °C	
C4	4.7 μ F	50 Vdc	
C5	100 nF	25 Vdc	
C6	1 nF	25 Vdc	
C7	100 nF	400 Vdc	
C8	100 nF	25 Vdc	
C9	1 nF	25 Vdc	
C10	3.9 nF	1000 Vdc	Panasonic ECQ P6392JU
C11	10 pF	500 Vdc	
C12	100 nF	25 Vdc	
C13	Not mounted		
C14	22 nF	50 Vdc	
R1	PCB fuse	6 A - 1 s	
R2	330 k Ω		
R3	330 k Ω		
R4	270 k Ω		
R5	2.94 k Ω	0.1%	
R6	10 Ω		
R7	47 Ω		
R8	10 Ω		
R9	470 Ω		
R10	1.2 Ω	1%	
R11	220 k Ω		
R12	220 k Ω		
R13	220 k Ω		
R14	560 k Ω		
R15	560 k Ω		
T1	2 x 33 mH CM-filter	440 mA / 250 Vac	SCLE16333-ITACOIL

Table 3. Bill of material (continued)

Reference	Value / part number	Rating	Notes
T2	5.6 : 1:1	12 mH	E0802-ITACOIL (<i>Figure 5</i>)
L1	3 mH	0.9 A	E16113-ITACOIL (<i>Figure 6</i>)
U1	L6520		
Q1	STT13005D		
Q2	STT13005D		
D1	B6S-E3/80		
D2	RB751V40T1		
D3	RB751V40T1		
D4	MMSD4148T1G		
D5	BZT03C15	3 W	
D6	MM3Z6V8ST1	6.8 V Zener	
D7	MM3Z6V8ST1	16 V Zener	
J1	V _{IN} connector	198-264 Vac	
J2	Lamp connector		

5.1 Board schematic

Figure 4. Board schematic

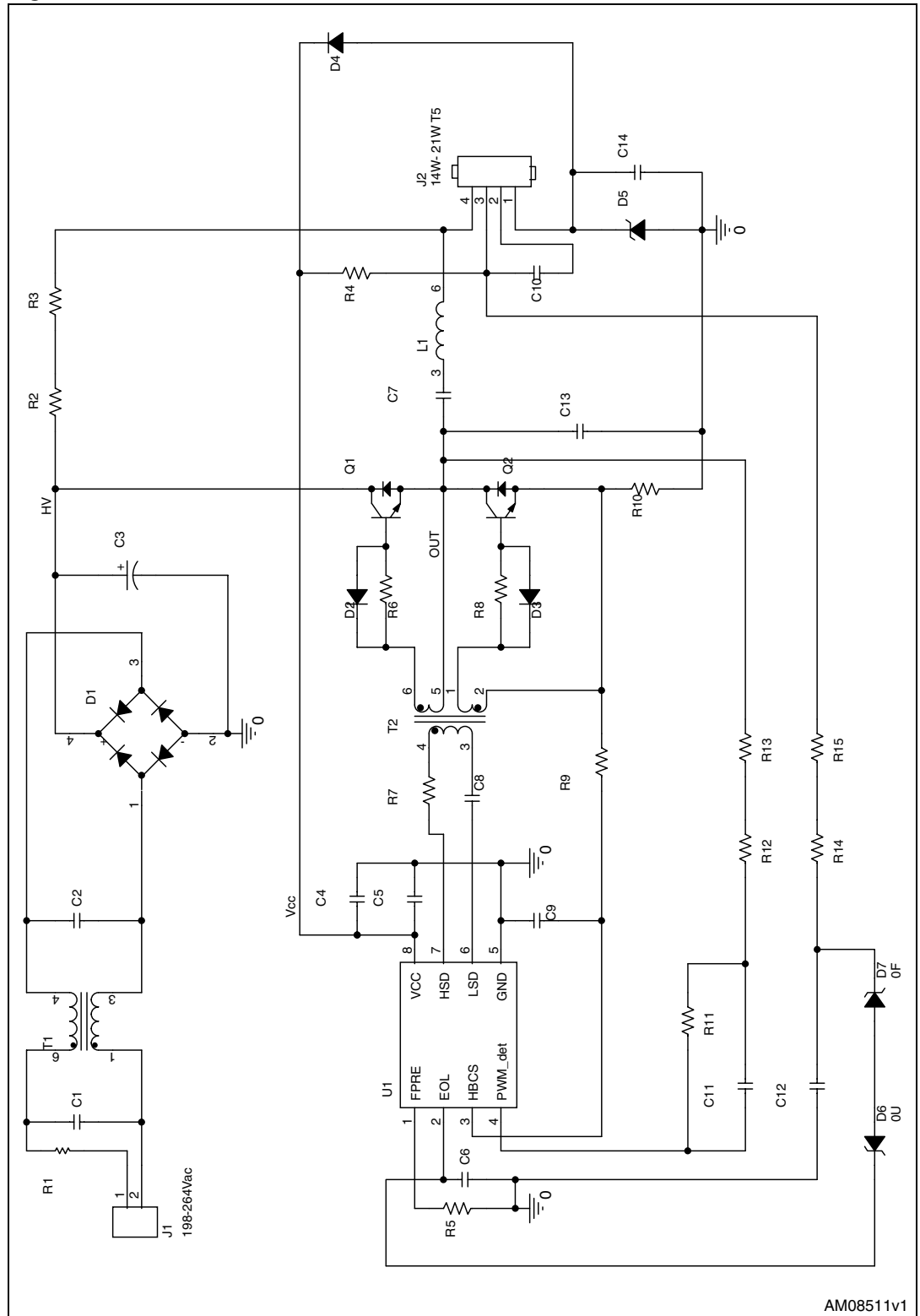

Appendix A Magnetic components data

Figure 5. Pulse transformer (T2) datasheet

PRODUCT DATASHEET

	CUSTOMER: ST Microelectronics Srl SAMPLING CODE: PRODUCT CODE: E0802	
Temporary product description* BJT driver transformer		L : 16,9mH min. (@10KHz-100mV)
W1	112 turns $\varnothing 0,08\text{mm}$ DCR: 6,6' +/-15%	
W2	20 turns $\varnothing 0,16\text{mm}$ DCR: 345 m' +/-15%	
4	20 turns $\varnothing 0,16\text{mm}$ DCR: 365 m' +/-15%	
Dielectric strenght	1000V/1sec. W1+W2+W3 / Core	
	1000V/2sec. W1/W2+W3	
Thermal class	B	
Bill of materials	Thermal Class	Standard
Magnet wire	T.I. 155°C (F)	EN60172
Bobbin material	T.I. 130°C (B) - 20.000h	UL94/V-0 - IEC 60695
Insulation tape	T.I. 130°C (B)	IEC 60112
Varnish	T.I. 155°C (F)	

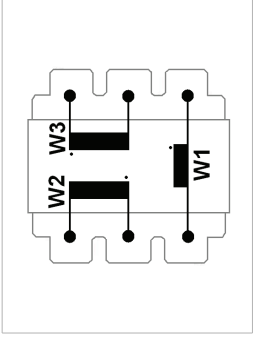

Layout (bottom view)

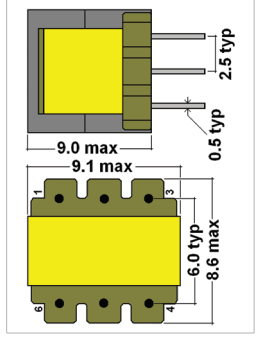

subject to change without notice

AM0774v1

Figure 6. Ballast choke (L1) datasheet

PRODUCT DATASHEET		
PRODUCT - REV	E16113	00
SAMPLING CODE	090710	
PRODUCT DESCRIPTION ¹		
Inductor 3.0 mH		
Thermal class	B	
Inductance	3,0 mH +/-7%	
DCR	8,0 Ω max	
Rated current	0,192A _{rms}	
Saturation current	> 0,65A _{pk}	
Max peak current	0,85A _{pk}	
Dielectric strenght	700Vac winding/core	
LAYOUT (BOTTOM VIEW)		
DRAWING		
DIMENSIONS (mm)		
A	17,30	MAX
B	17,20	MAX
H	12,50	MAX
X	3,80	Typ
X1	7,60	Typ
Y	12,50	Typ
D	0,60	Typ Ø
L	5,50	Typ
COMPONENTS ²		
Magnet wire	T.I. 155°C (F)	EN60172
Bobbin material	T.I. 130°C (B) - 20.000h	UL94/V-0 - IEC 60695
Insulation tape	T.I. 130°C (B)	IEC 60112
Varnish	T.I. 155°C (F)	
<p>All the items, except those defined "safety transformers in compliance to the European standards EN61558-1 and EN61558-2-6" in our catalogue, are supplied as a semi-finished component for specific use into electronic equipments designed by the client. Type testing and any other valuation necessary to verify the compliance of the characteristics of the transformer with the technical, safety and any other requirement have to be done by the user, before using. Each requirement and test has to be requested in writing; without written instructions the product will be tested according to our Quality System standards.</p> <p>ST1 - ENG rev. 01 - 16/06/2010 subject to change without notice</p>		
<p>1. Some data can be changed following type tests 2. Only take into account materials actually present</p>		

AM07475v1

Revision history

Table 4. Revision history

Date	Revision	Changes
07-Mar-2011	1	Initial release.
28-Nov-2011	2	Updated Section 2 and Table 3 .

Please Read Carefully:

Information in this document is provided solely in connection with ST products. STMicroelectronics NV and its subsidiaries ("ST") reserve the right to make changes, corrections, modifications or improvements, to this document, and the products and services described herein at any time, without notice.

All ST products are sold pursuant to ST's terms and conditions of sale.

Purchasers are solely responsible for the choice, selection and use of the ST products and services described herein, and ST assumes no liability whatsoever relating to the choice, selection or use of the ST products and services described herein.

No license, express or implied, by estoppel or otherwise, to any intellectual property rights is granted under this document. If any part of this document refers to any third party products or services it shall not be deemed a license grant by ST for the use of such third party products or services, or any intellectual property contained therein or considered as a warranty covering the use in any manner whatsoever of such third party products or services or any intellectual property contained therein.

UNLESS OTHERWISE SET FORTH IN ST'S TERMS AND CONDITIONS OF SALE ST DISCLAIMS ANY EXPRESS OR IMPLIED WARRANTY WITH RESPECT TO THE USE AND/OR SALE OF ST PRODUCTS INCLUDING WITHOUT LIMITATION IMPLIED WARRANTIES OF MERCHANTABILITY, FITNESS FOR A PARTICULAR PURPOSE (AND THEIR EQUIVALENTS UNDER THE LAWS OF ANY JURISDICTION), OR INFRINGEMENT OF ANY PATENT, COPYRIGHT OR OTHER INTELLECTUAL PROPERTY RIGHT.

UNLESS EXPRESSLY APPROVED IN WRITING BY TWO AUTHORIZED ST REPRESENTATIVES, ST PRODUCTS ARE NOT RECOMMENDED, AUTHORIZED OR WARRANTED FOR USE IN MILITARY, AIR CRAFT, SPACE, LIFE SAVING, OR LIFE SUSTAINING APPLICATIONS, NOR IN PRODUCTS OR SYSTEMS WHERE FAILURE OR MALFUNCTION MAY RESULT IN PERSONAL INJURY, DEATH, OR SEVERE PROPERTY OR ENVIRONMENTAL DAMAGE. ST PRODUCTS WHICH ARE NOT SPECIFIED AS "AUTOMOTIVE GRADE" MAY ONLY BE USED IN AUTOMOTIVE APPLICATIONS AT USER'S OWN RISK.

Resale of ST products with provisions different from the statements and/or technical features set forth in this document shall immediately void any warranty granted by ST for the ST product or service described herein and shall not create or extend in any manner whatsoever, any liability of ST.

ST and the ST logo are trademarks or registered trademarks of ST in various countries.

Information in this document supersedes and replaces all information previously supplied.

The ST logo is a registered trademark of STMicroelectronics. All other names are the property of their respective owners.

© 2011 STMicroelectronics - All rights reserved

STMicroelectronics group of companies

Australia - Belgium - Brazil - Canada - China - Czech Republic - Finland - France - Germany - Hong Kong - India - Israel - Italy - Japan - Malaysia - Malta - Morocco - Philippines - Singapore - Spain - Sweden - Switzerland - United Kingdom - United States of America

www.st.com