

Low noise, High PSRR, High speed, CMOS LDO

Descriptions

The WL2801E series is a high accuracy, low noise, high speed, low dropout CMOS Linear regulator with high ripple rejection. The devices offer a new level of cost effective performance in cellular phones, laptop and notebook computers, and other portable devices.

The current limiter's fold-back circuit also operates as a short circuit protection and an output current limiter at the output pin.

The WL2801E regulators are available in standard SOT-23-5L packages. Standard products are Pb-free and Halogen-free.

Features

- Input voltage : 2.7V~5.5V
- Output range : 1.2V~3.3V
- Output current : 200mA (Up to 300mA Typ.)
- PSRR : 75dB @ 217Hz
- Dropout voltage : 170mV @ I_{OUT}=200mA
- Quiescent current : 70µA Typ.
- Shut-down current : < 0.1µA
- Recommend capacitor : 1µF

Applications

- MP3/MP4 Players
- Cellphones, radiophone, digital cameras
- Bluetooth, wireless handsets
- Others portable electronics device



SOT-23-5L

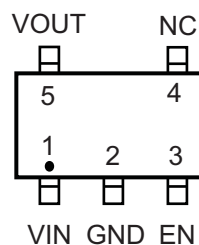

Pin Configuration (Top View)

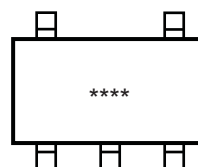

For detail marking information, please see page 9.

Marking

Order Information

For detail order information, please see page 9.

Typical Application

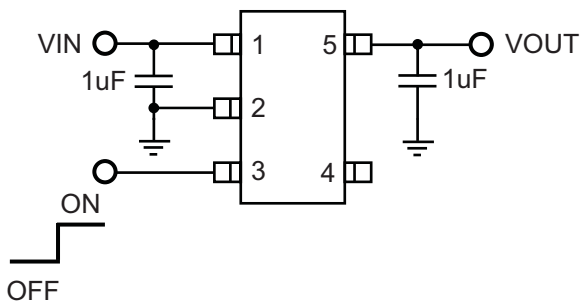

Pin Description

PIN	Symbol	Description
1	VIN	Input
2	GND	Ground
3	EN	Enable (Active high)
4	NC	Not connected
5	VOUT	Output

Block Diagram

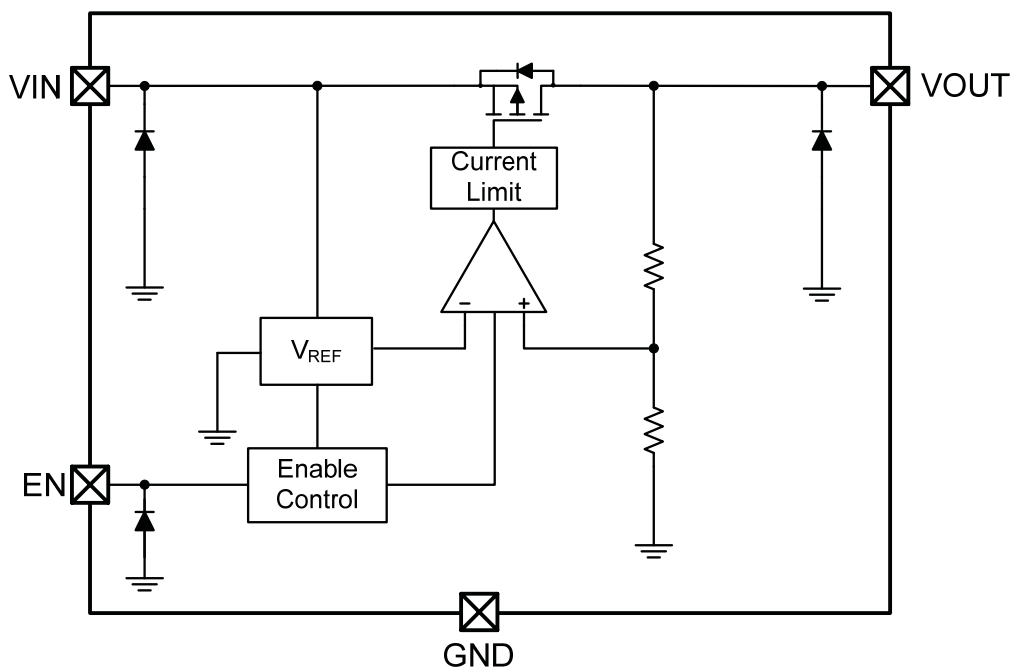

Absolute Maximum Ratings

Parameter	Value	Unit
Power Dissipation	Internal limited	mW
V _{IN} Range	-0.3 ~ 6.5	V
V _{EN} Range	-0.3 ~ V _{IN}	V
V _{OUT} Range	-0.3 ~ V _{IN}	V
Lead Temperature Range	260	°C
Storage Temperature Range	-55 ~ 150	°C
Operating Junction Temperature Range	150	°C

Recommend Operating Ratings

Parameter	Value	Unit
Operating Supply voltage	2.7 ~ 5.5	V
Operating Temperature Range	-40 ~ 85	°C
Thermal Resistance, R _{θJA}	250	°C/W

Electronics Characteristics (T_a=25°C, V_{IN}=V_{OUT}+1V, C_{IN}=C_{OUT}=1μF, unless otherwise noted)

Parameter	Symbol	Condition	Min.	Typ.	Max.	Unit
Output Voltage	V _{OUT}	V _{OUT} < 2V, V _{IN} =2.7V, I _{OUT} =1mA	0.97 V _{OUT}	V _{OUT}	1.03 V _{OUT}	V
		V _{OUT} ≥ 2V, I _{OUT} =1mA	0.98 V _{OUT}	V _{OUT}	1.02 V _{OUT}	
Current Limit	I _{LIM}	V _{EN} =V _{IN}	Ref. to Output Voltage vs. Output Current Chart			mA
Dropout Voltage	V _{DROP}	V _{OUT} =2.8V, I _{OUT} =200mA		170	200	mV
		V _{OUT} =2.8V, I _{OUT} =300mA		250	300	
Line Regulation	ΔV _{LINE}	V _{IN} =2.7~5.5V, I _{OUT} =1mA		0.01	0.15	%/V
Load Regulation	ΔV _{Load}	V _{OUT} =2.8V, I _{OUT} =1~300mA		20	30	mV
Quiescent Current	I _Q	V _{OUT} =2.8V, I _{OUT} =0		70	100	μA
Short Current	I _{SHORT}	V _{EN} =V _{IN} , V _{OUT} Short to GND with 1Ω		170		mA
Shut-down Current	I _{SHDN}	V _{EN} =0V		0.1	1.0	μA
Power Supply Rejection Rate	PSRR	V _{IN} =(V _{OUT} +1V) _{DC} +0.5V _{P-P} F=217Hz, I _{OUT} =10mA		75		dB
		V _{IN} =(V _{OUT} +1V) _{DC} +0.5V _{P-P} F=10KHz, I _{OUT} =10mA		65		
EN logic high voltage	V _{ENH}	V _{IN} =5.5V, I _{OUT} =1mA	1.2			V
EN logic low voltage	V _{ENL}	V _{IN} =5.5V, V _{OUT} =0V			0.4	V
EN Input Current	I _{EN}	V _{EN} = 0 to 5.5V			1.0	μA
Output Noise Voltage	e _{NO}	10Hz to 100KHz, C _{OUT} =1μF		100		μV _{RMS}

Typical characteristics ($T_a=25^\circ\text{C}$, $V_{IN}=V_{OUT}+1\text{V}$, $C_{IN}=C_{OUT}=1\mu\text{F}$, unless otherwise noted)

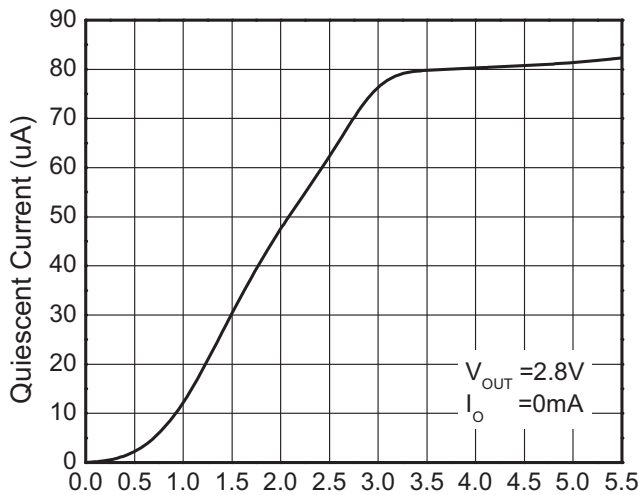

Quiescent current vs. Supply voltage

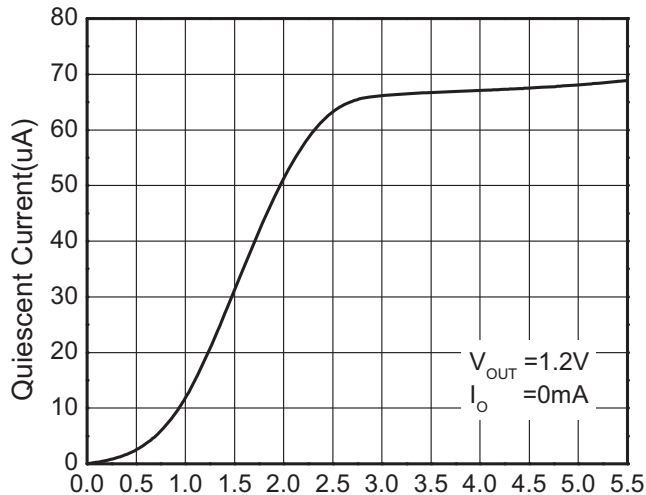

Quiescent current vs. Supply voltage

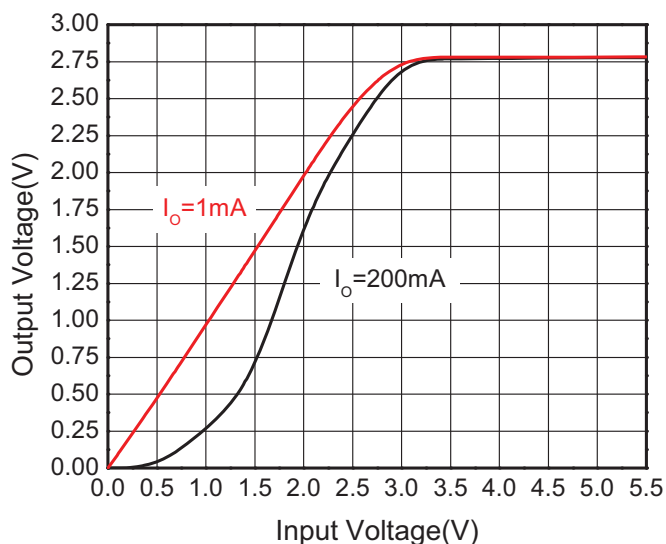

Output voltage vs. Supply voltage

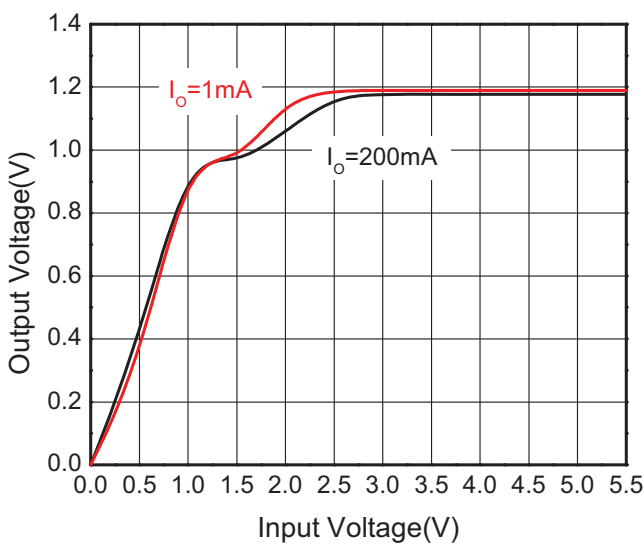

Output voltage vs. Supply voltage

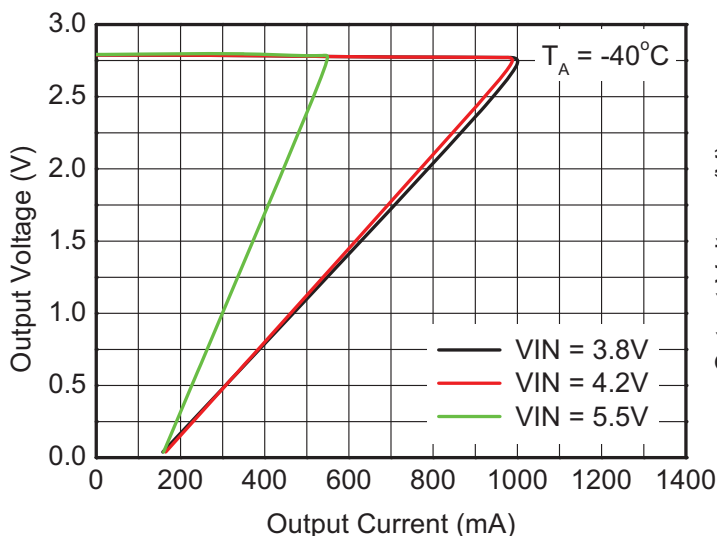

Output voltage vs. Output current

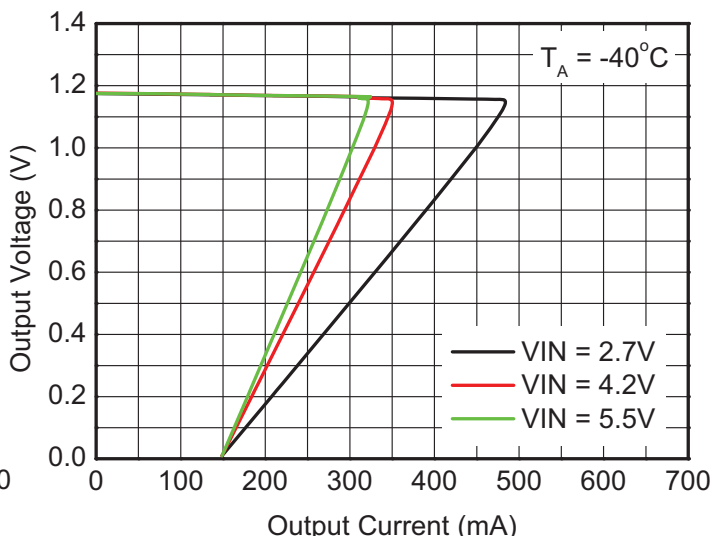

Output voltage vs. Output current

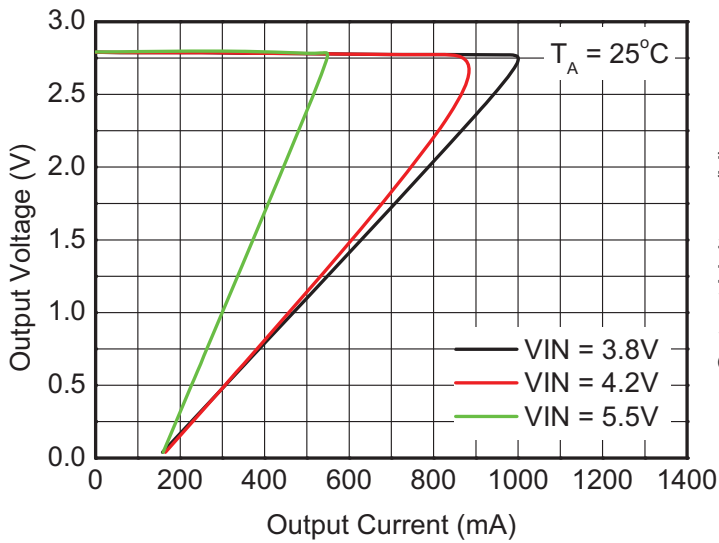

Output voltage vs. Output current

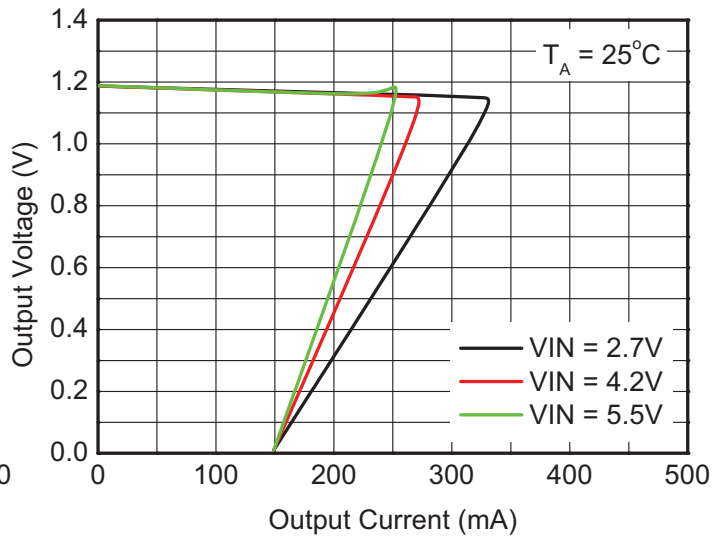

Output voltage vs. Output current

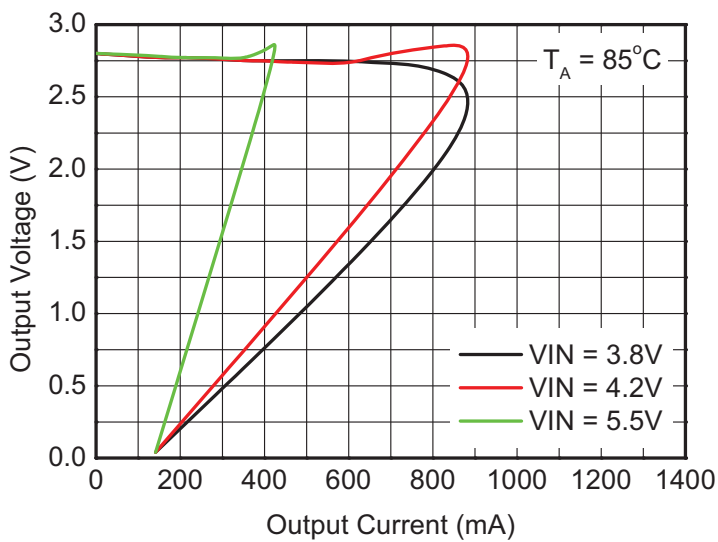

Output voltage vs. Output current

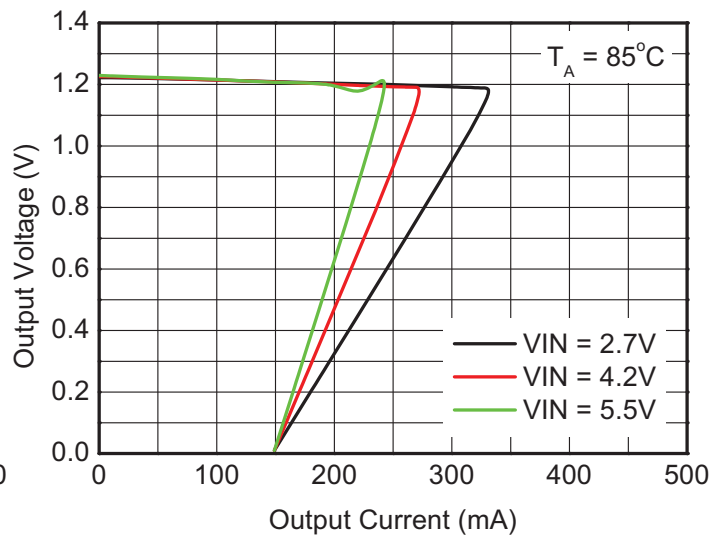

Output voltage vs. Output current

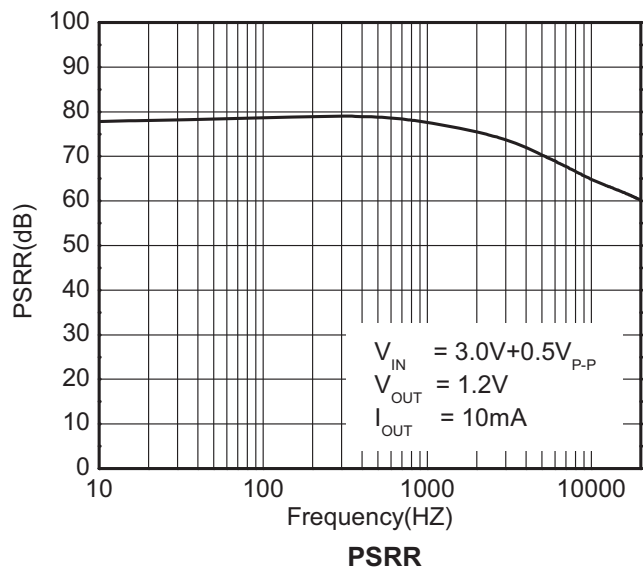
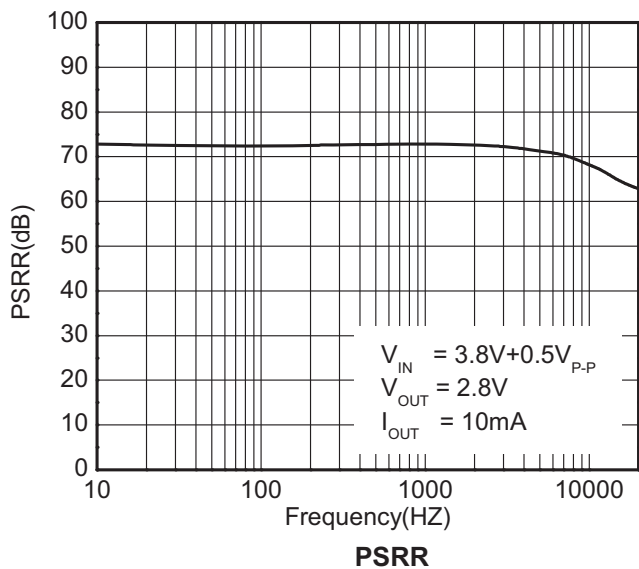

WL2801E

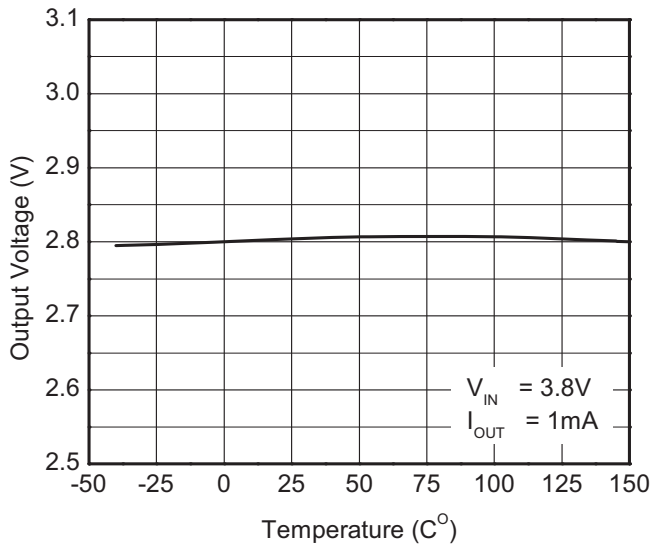

Output voltage vs. Temperature

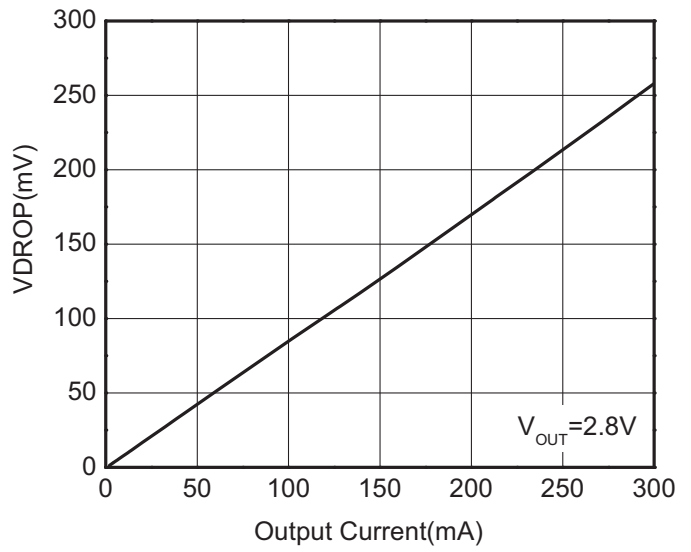

Output voltage vs. Temperature

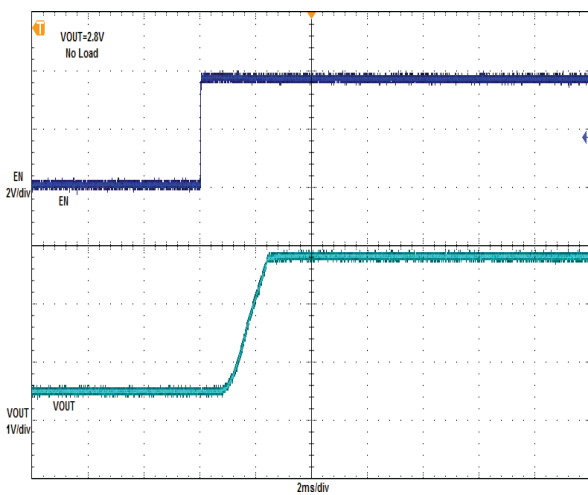

Start Up

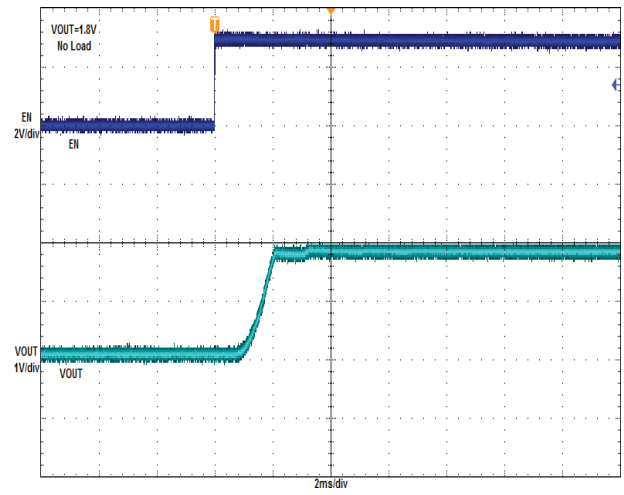

Start Up

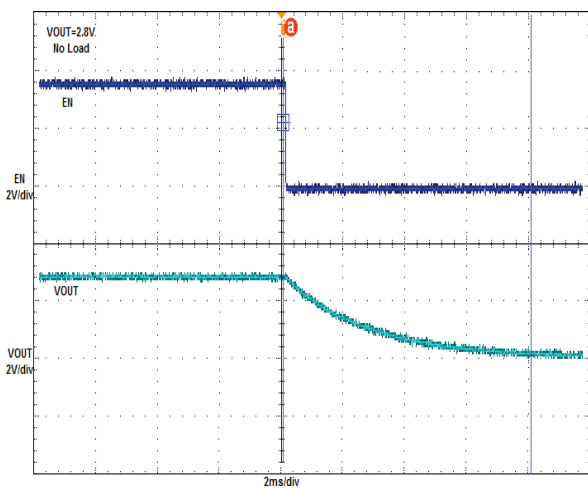

Shutdown

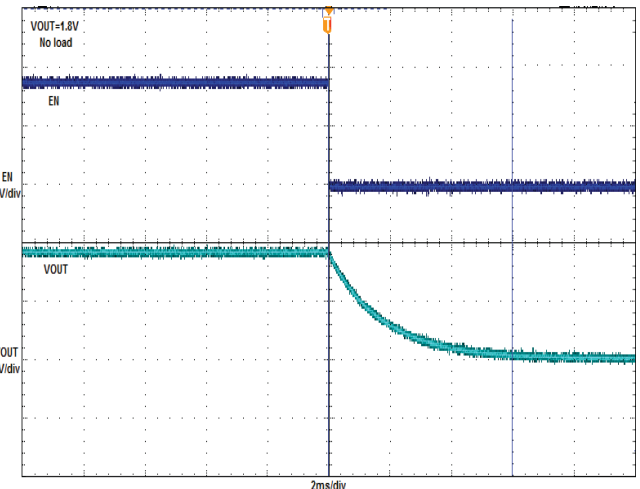

Shutdown

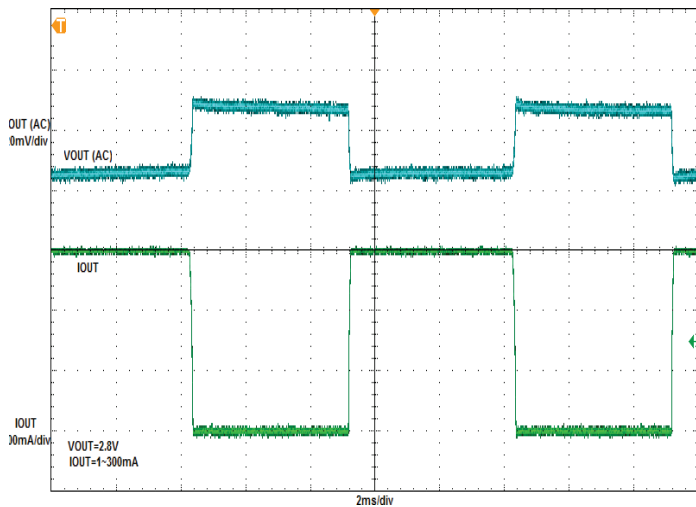

Load Step

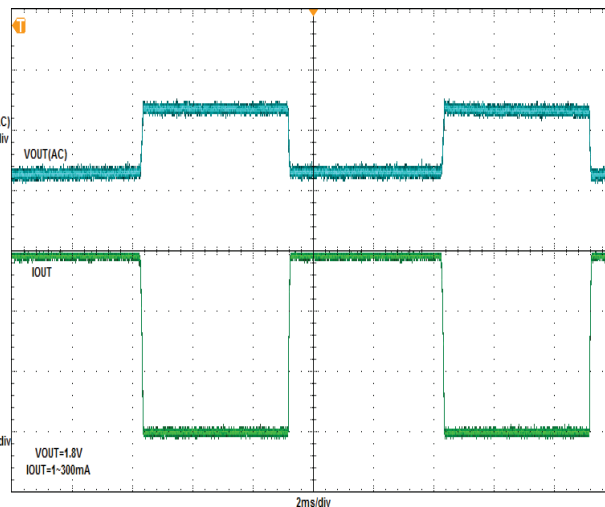

Load Step

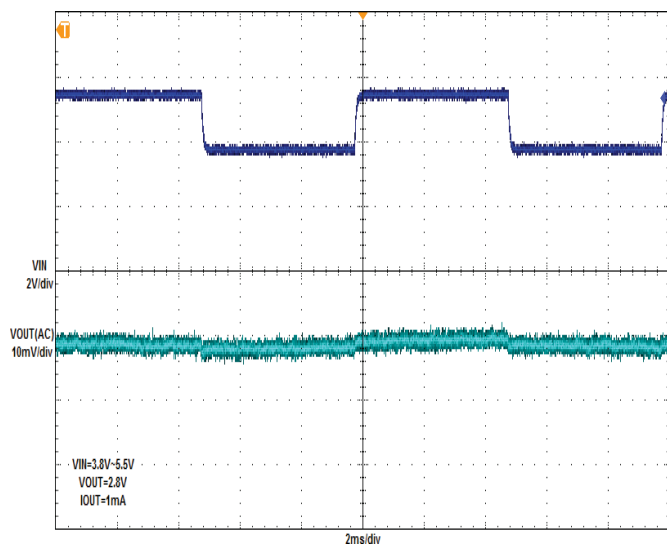

Line Step

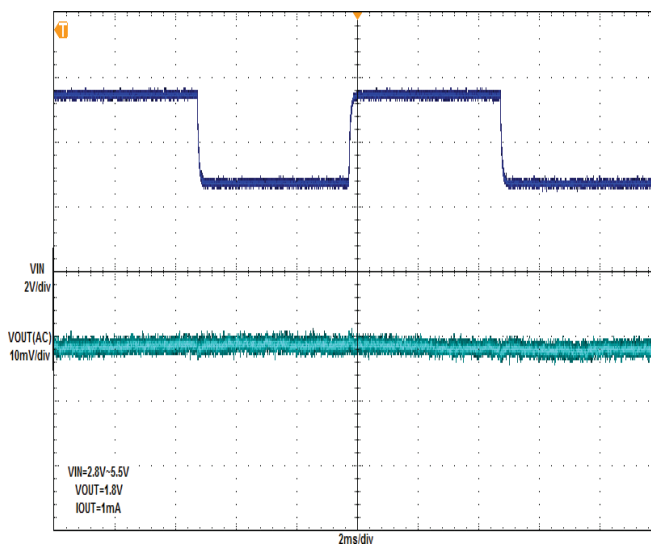

Line Step

Packaging Information

SOT-23-5L

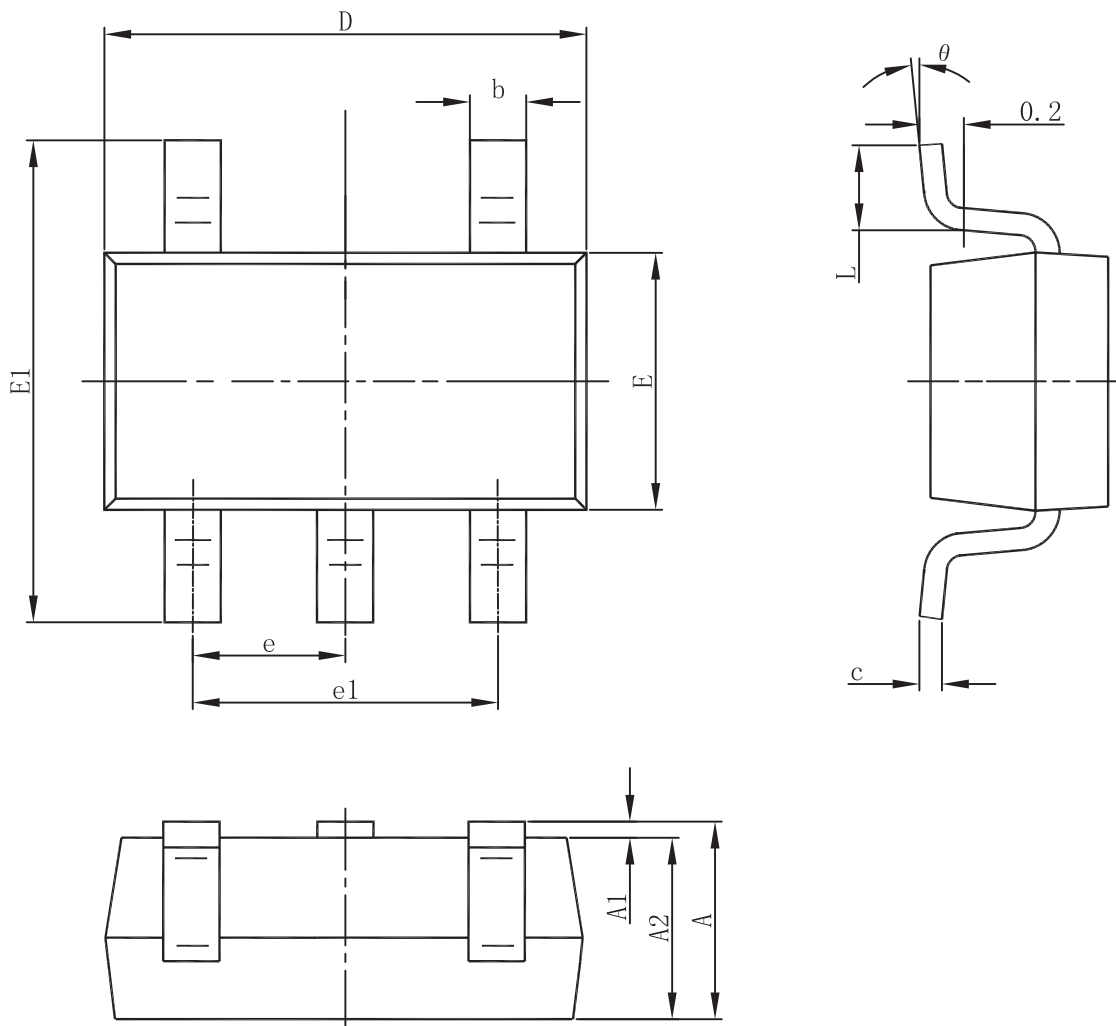

Symbol	Dimensions In Millimeters		
	Min.	Typ.	Max.
A	1.050	-	1.250
A1	0.000	-	0.100
A2	1.050	-	1.150
b	0.300	0.4	0.500
c	0.100	-	0.200
D	2.820	2.9	3.020
E	1.500	1.6	1.700
E1	2.650	2.8	2.950
e	0.950 (Basic)		
e1	1.800	1.9	2.000
L	0.300	0.45	0.600
θ	0°	-	8°

ORDER INFORMATION

Ordering No.	Vout (V)	Package	Operating Temperature	Marking	Shipping
WL2801E12-5/TR	1.2	SOT-23-5L	-40~+85°C	WE12 YYWW	Tape and Reel, 3000
WL2801E13-5/TR	1.3	SOT-23-5L	-40~+85°C	WE13 YYWW	Tape and Reel, 3000
WL2801E15-5/TR	1.5	SOT-23-5L	-40~+85°C	WE15 YYWW	Tape and Reel, 3000
WL2801E18-5/TR	1.8	SOT-23-5L	-40~+85°C	WE18 YYWW	Tape and Reel, 3000
WL2801E25-5/TR	2.5	SOT-23-5L	-40~+85°C	WE25 YYWW	Tape and Reel, 3000
WL2801E28-5/TR	2.8	SOT-23-5L	-40~+85°C	WE28 YYWW	Tape and Reel, 3000
WL2801E30-5/TR	3.0	SOT-23-5L	-40~+85°C	WE30 YYWW	Tape and Reel, 3000
WL2801E33-5/TR	3.3	SOT-23-5L	-40~+85°C	WE33 YYWW	Tape and Reel, 3000

Marking:

WE** = Device Code

YY = Year

WW = Week