



ACE7433M

P-Channel 30-V MOSFET

Description

The ACE7433M uses advanced trench technology to provide excellent $R_{DS(ON)}$, low gate charge. This device is suitable for use as a high side switch in SMPS and general purpose applications.

Features

- Low $r_{DS(on)}$ trench technology
- Low thermal impedance
- Fast switching speed

Applications

- White LED boost converters
- Automotive Systems
- Industrial DC/DC Conversion Circuits

Absolute Maximum Ratings

Parameter		Symbol	Limit	Units
Drain-Source Voltage		V_{DS}	-30	V
Gate-Source Voltage		V_{GS}	± 20	V
Continuous Drain Current ^a	$T_A=25^\circ\text{C}$	I_D	-20	A
	$T_A=70^\circ\text{C}$		-16	
Pulse Drain Current ^b		I_{DM}	-50	
Continuous Drain Current (Diode Continuous) ^a		I_S	-7.3	A
Power Dissipation ^a	$T_A=25^\circ\text{C}$	P_D	5	W
	$T_A=70^\circ\text{C}$		3.2	
Operating Junction and Storage Temperature Range		T_J, T_{STG}	-55 to 150	$^\circ\text{C}$

Parameter		Symbol	Maximum	Units
Maximum Junction-to-Ambient ^a	$t \leq 10\text{s}$	$R_{\theta JA}$	25	$^\circ\text{C/W}$
	Steady State		65	$^\circ\text{C/W}$

Notes

a. Surface Mounted on 1" x 1" FR4 Board.

b. Pulse width limited by maximum junction temperature



ACE7433M

P-Channel 30-V MOSFET

Packaging Type

DFN5*6-8L

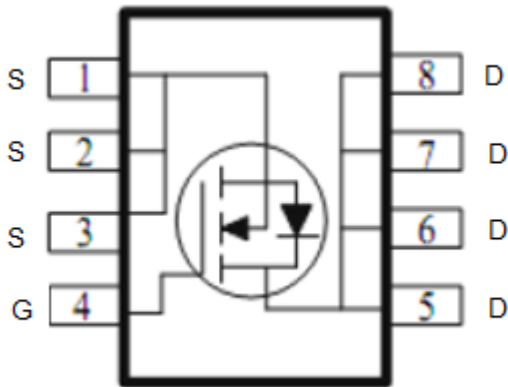

Ordering information

ACE7433M PN + H

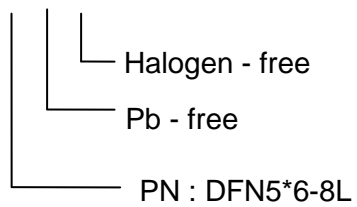



ACE7433M

P-Channel 30-V MOSFET

Electrical Characteristics $T_A=25^\circ\text{C}$ unless otherwise noted

Parameter	Symbol	Conditions	Min.	Typ.	Max.	Unit
Static						
Gate Source Threshold Voltage	$V_{GS(th)}$	$V_{DS}=V_{GS}, I_D=-250\mu\text{A}$	-1			V
Gate Body Leakage	I_{GSS}	$V_{DS}=0\text{V}, V_{GS}=\pm 20\text{V}$			± 100	nA
Zero Gate Voltage Drain Current	I_{DSS}	$V_{DS}=-24\text{V}, V_{GS}=0\text{V}$			-1	uA
		$V_{DS}=-24\text{V}, V_{GS}=0\text{V}, T_J=55^\circ\text{C}$			-25	
On-State Drain-Current ^a	$I_{D(on)}$	$V_{DS}=-5\text{V}, V_{GS}=-10\text{V}$	-30			A
Static Drain-Source On-Resistance ^a	$r_{DS(ON)}$	$V_{GS}=-10\text{V}, I_D=-15.3\text{A}$			9	m Ω
		$V_{GS}=-4.5\text{V}, I_D=-12.3\text{A}$			13	
Forward Transconductance ^a	g_{fs}	$V_{GS}=-15\text{V}, I_D=-15.3\text{A}$		34		S
Diode Forward Voltage ^a	V_{SD}	$I_S=-3.7\text{A}, V_{GS}=0\text{V}$		-0.72		V
Dynamic ^b						
Total Gate Charge	Q_g	$V_{DS}=-15\text{V}, V_{GS}=-4.5\text{V}, I_D=-15.3\text{A}$		140		nC
Gate-Source Charge	Q_{gs}			35		
Gate-Drain Charge	Q_{gd}			62		
Turn-On Delay Time	$t_{d(on)}$	$V_{DS}=-15\text{V}, R_L=0.9\Omega, I_D=-15.3\text{A}, V_{GS}=-10\text{V}, R_{GEN}=6\Omega,$		18		ns
Rise Time	t_f			87		
Turn-Off Delay Time	$t_{d(off)}$			345		
Fall Time	t_f			226		
Input Capacitance	C_{iss}	$V_{DS}=-15\text{V}, V_{GS}=0\text{V}, f=1\text{MHz}$		8500		pF
Output Capacitance	C_{oss}			1291		
Reverse Transfer Capacitance	C_{rss}			939		

Note:

- a. Pulse test: $PW \leq 300\mu\text{s}$ duty cycle $\leq 2\%$.
- b. Guaranteed by design, not subject to production testing.



ACE7433M

P-Channel 30-V MOSFET

Typical Performance Characteristics

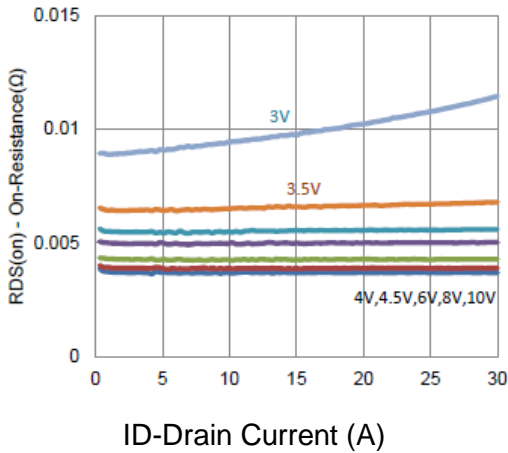

1. On-Resistance vs. Drain Current

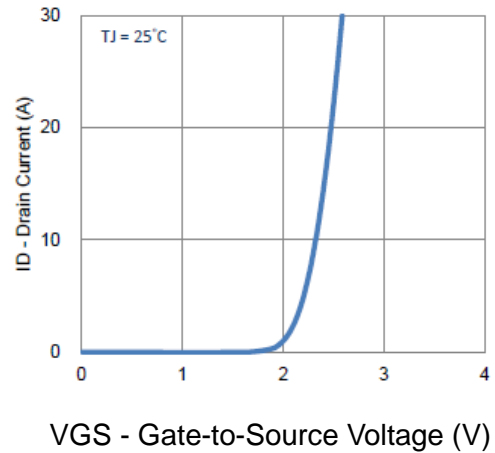

2. Transfer Characteristics

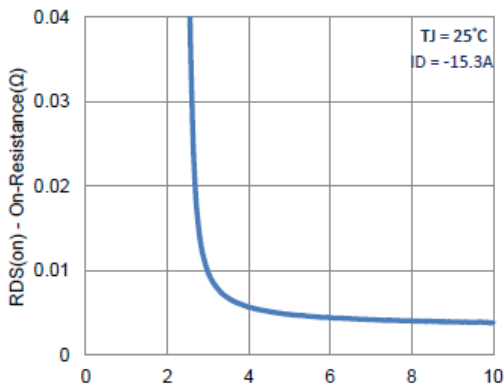

3. On-Resistance vs. Gate-to-Source Voltage

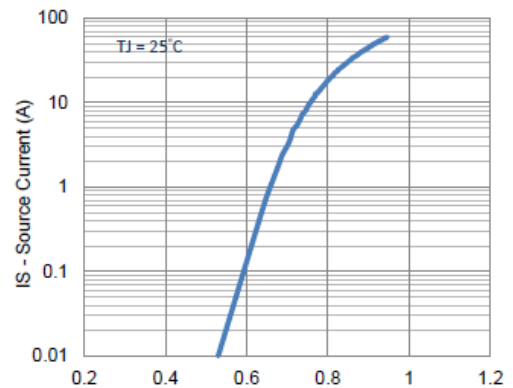

4. Drain-to-Source Forward Voltage

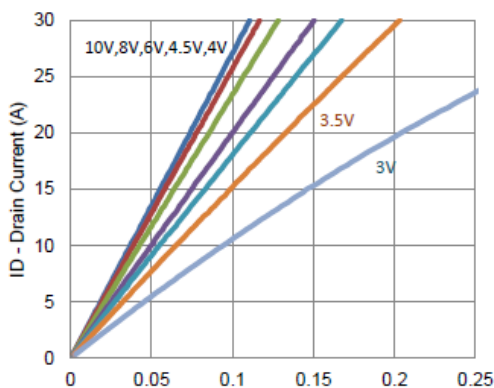

5. Output Characteristics

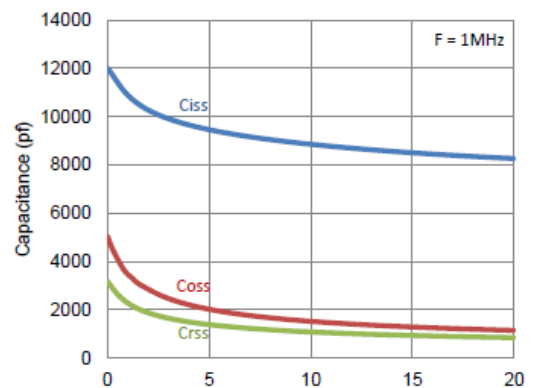

6. Capacitance



ACE7433M

P-Channel 30-V MOSFET

Typical Performance Characteristics

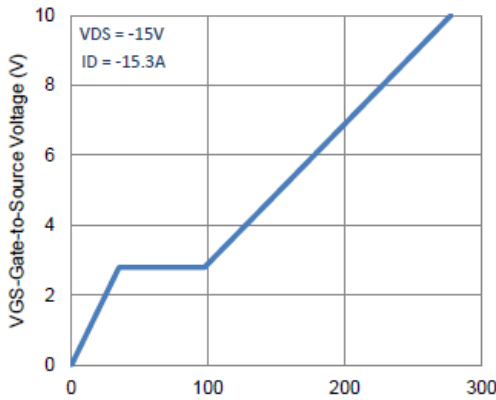

Qg - Total Gate Charge (nC)
7. Gate Charge

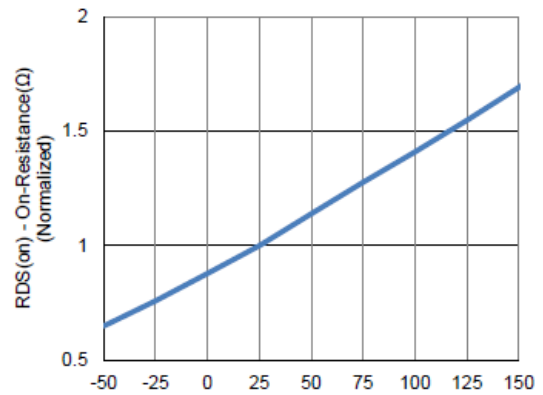

TJ - Junction Temperature (°C)
8. Normalized On-Resistance Vs Junction Temperature

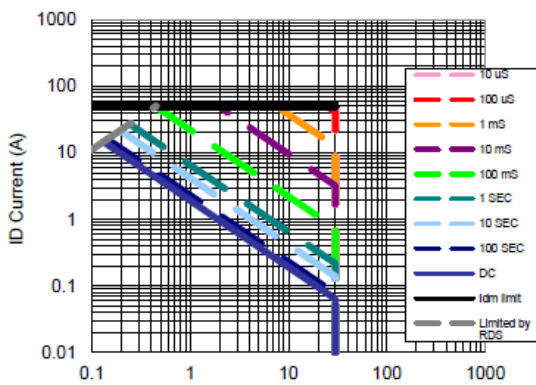

VDS Drain to Source Voltage (V)
9. Safe Operating Area

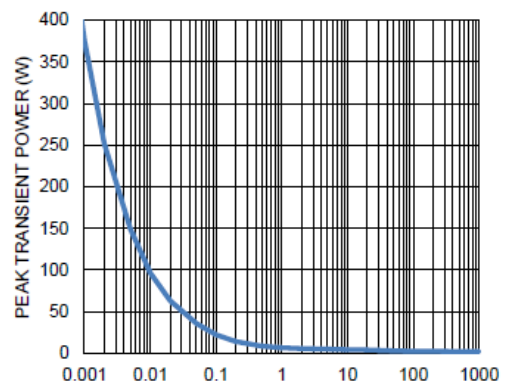

t1 TIME (SEC)
10. Single Pulse Maximum Power Dissipation

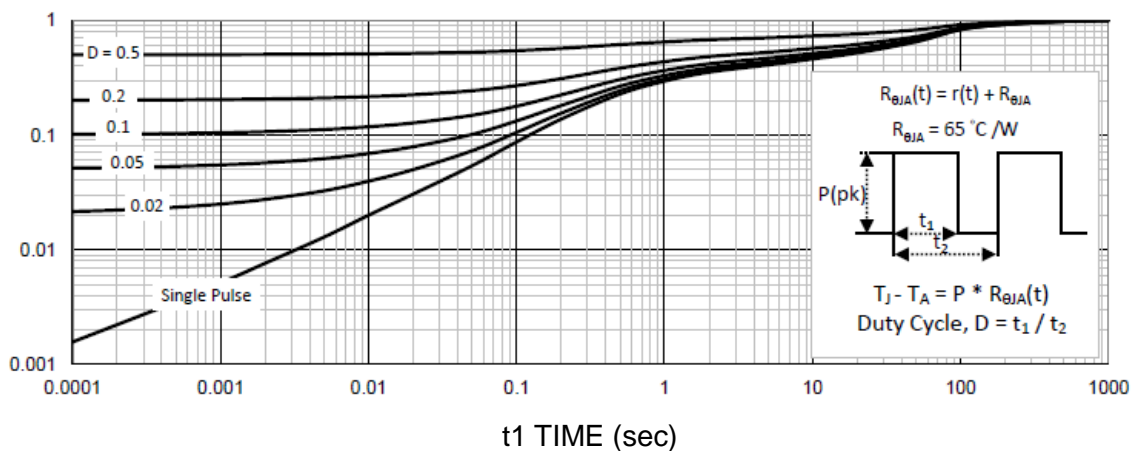

t1 TIME (sec)
11. Normalized Thermal Transient Junction to Ambient



ACE7433M

P-Channel 30-V MOSFET

Packing Information

DFN5*6-8L

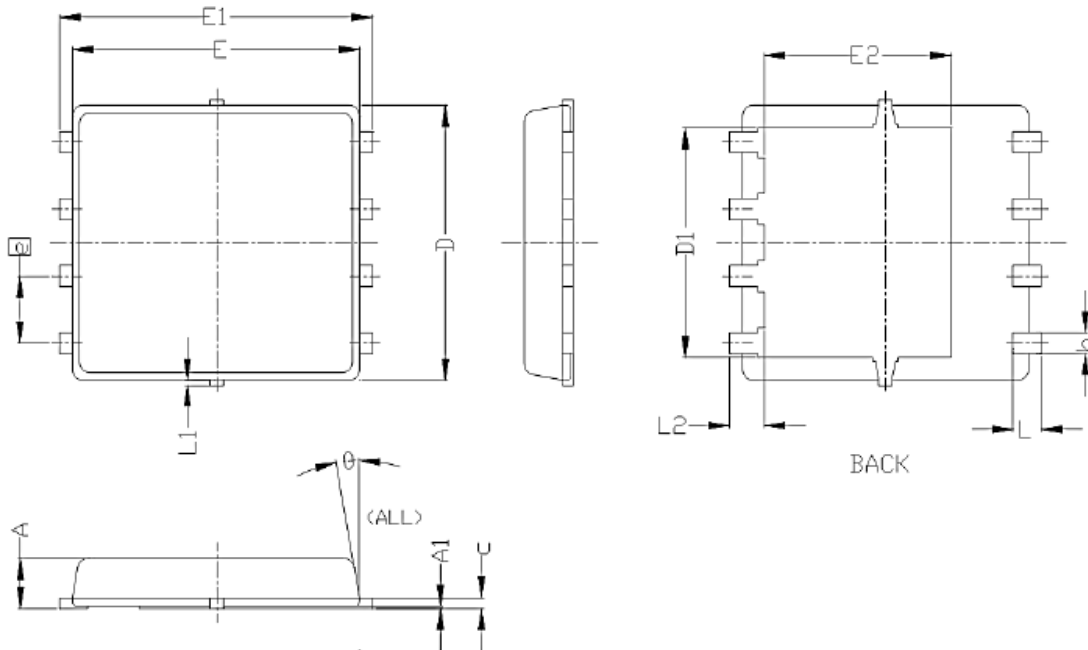

SYMBOLS	DIMENSIONS IN MILLIMETERS			DIENSIONS IN INCHES		
	MIN	NOM	MAX	MIN	NOM	MAX
A	0.85	0.95	1.00	0.033	0.037	0.039
A1	0.00		0.05	0.000		0.002
b	0.30	0.40	0.50	0.012	0.016	0.020
c	0.15	0.20	0.25	0.006	0.008	0.010
D	5.20 BSC			0.205 BSC		
D1	4.35 BSC			0.171 BSC		
E	5.55 BSC			0.219 BSC		
E1	6.05 BSC			0.238 BSC		
E2	3.62 BSC			0.143 BSC		
e	1.27 BSC			0.050 BSC		
L	0.45	0.55	0.65	0.018	0.022	0.026
L1	0		0.15	0		0.006
L2	0.68 REF			0.027 REF		
θ	0°		10°	0°		10°



ACE7433M

P-Channel 30-V MOSFET

Notes

ACE does not assume any responsibility for use as critical components in life support devices or systems without the express written approval of the president and general counsel of ACE Electronics Co., LTD. As sued herein:

1. Life support devices or systems are devices or systems which, (a) are intended for surgical implant into the body, or (b) support or sustain life, and whose failure to perform when properly used in accordance with instructions for use provided in the labeling, can be reasonably expected to result in a significant injury to the user.
2. A critical component is any component of a life support device or system whose failure to perform can be reasonably expected to cause the failure of the life support device or system, or to affect its safety or effectiveness.

ACE Technology Co., LTD.
<http://www.ace-ele.com/>