

AN2527NFHP

Signal Processor for IC Color LCD

Overview

The AN2527NFHP is a signal processor IC for video camera with a color-LCD. It alternates RGB components of a video signal at intervals of 1H. It is for 12 to 14V LCD panel.

Features

- Compatible with NTSC and PAL
- Built-in color-character insertion circuit
- Responding to composite and component signal processing
- Built-in a γ correction circuit

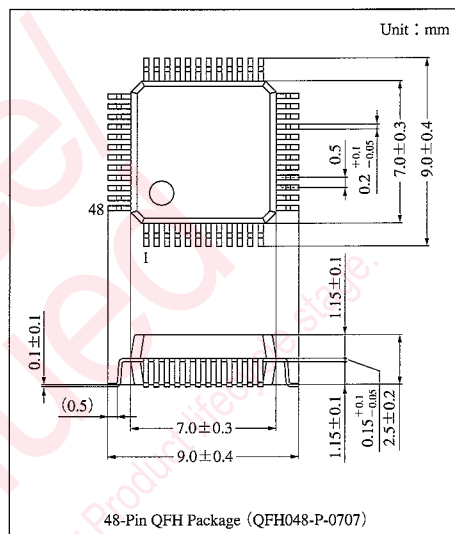

Absolute Maximum Ratings (Ta = 25 °C)

Parameter	Symbol	Rating	Unit
Supply voltage	V _{CC1}	5.5	V
	V _{CC2}	15.5	
Power dissipation ^{Note 2)}	P _D	209	mW
Operating ambient temperature ^{Note 1)}	T _{opr}	-20 to +70	°C
Storage temperature ^{Note 1)}	T _{stg}	-55 to +125	°C

Note 1) Ta = 25 °C except operating ambient temperature and storage temperatures unless otherwise specified.

Note 2) Allowable power dissipation of the package at Ta = 70 °C.

Recommended Operating Range (Ta = 25 °C)

Parameter	Symbol	Range
Operating supply voltage range	V _{CC1}	4.5V to 5.1V
	V _{CC2}	11.5V to 15.3V

Block Diagram

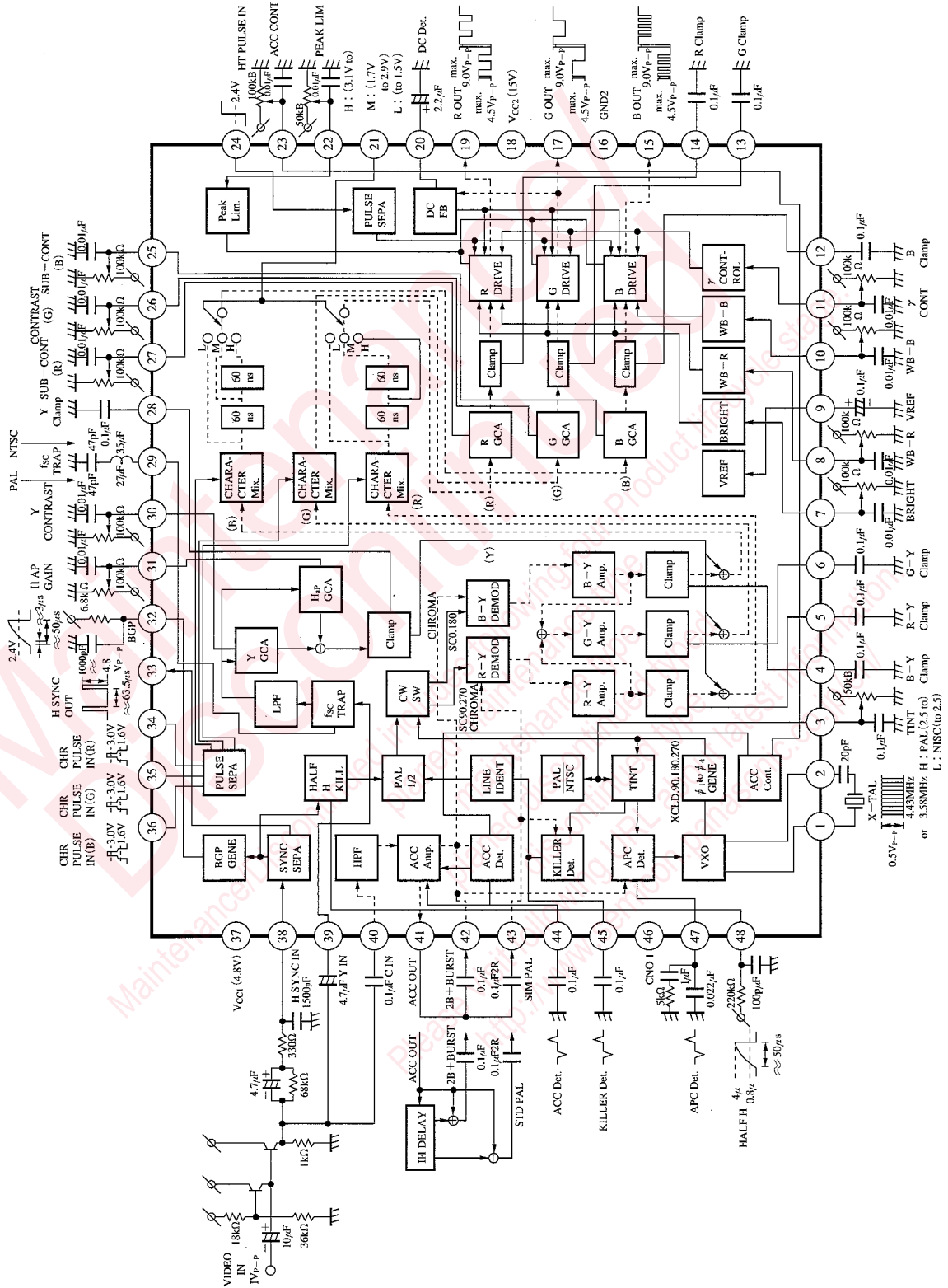

ICs for Video Camera

■ Electrical Characteristics (Ta=25±2°C)



Parameter	Symbol	Condition	min	typ	max	Unit
Circuit current (4.8V system)	I ₃₇	V _{CC1} =4.8V, V _{CC2} =15V	19	24	29	mA
Circuit current (15V system)	I ₁₈	V _{CC1} =4.8V, V _{CC2} =15V	1	3	6	mA
APC pull-in (Hi)	AP _H	V _{CC1} =4.8V, V _{CC2} =15V	0.5	—	—	kHz
APC pull-in (Low)	AP _L	V _{CC1} =4.8V, V _{CC2} =15V	—	—	-0.5	kHz
ACC output characteristics	AC ₄₁	Input=600mV _{P-P}	300	500	700	mV _{P-P}
ACC control characteristics	AG ₂₃	Input=600mV _{P-P}	5.0	8.0	11.0	dB
TINT control sensitivity	TI ₃	V ₃ =1.0/2.0V	100	350	600	mV _{P-P}
Killer characteristics	VK ₄₅	V _{CC1} =4.8V, V _{CC2} =15V	—	—	50	mV _{P-P}
Chroma leak (in case of killer-on)	L _K	V _{CC1} =4.8V, V _{CC2} =15V	—	—	-20	dB
SYNC output amplitude	V ₃₃	Input=1.0V _{P-P}	4.0	—	—	V _{P-P}
Minimum synchronous separation capability	MS ₃₃	Input=1.0V _{P-P}	—	—	80	mV _{P-P}
Y contrast adjustment	YC ₃₀	V ₃₀ =1.5/2.5V	3.7	5.7	7.7	dB
Sharpness adjustment	SH ₃₁	Input=1.0V _{P-P}	3	6	9.0	dB
Character level threshold (M)	V _{T(M)}	V _{CC1} =4.8V, V _{CC2} =15V	1.3	1.6	1.9	V
Character level threshold (H)	V _{T(H)}	V _{CC1} =4.8V, V _{CC2} =15V	2.7	3.0	3.3	V
DL threshold (M)	V _{DM}	V _{CC1} =4.8V, V _{CC2} =15V	1.3	1.6	1.9	V
DL threshold (H)	V _{DH}	V _{CC1} =4.8V, V _{CC2} =15V	2.7	3.0	3.3	V
Contrast (G ch)	CG ₂₆	Input=1.0V _{P-P}	3.0	4.0	5.0	dB
Sub-contrast (R ch)	SR ₂₇	Input=1.0V _{P-P}	1.0	2.0	3.0	dB
Sub-contrast (B ch)	SB ₂₅	Input=1.0V _{P-P}	1.0	2.0	3.0	dB
γ characteristics (1)	γ _{11A}	Input=1.0V _{P-P}	5.0	7.5	10.0	dB
γ characteristics (2)	γ _{11B}	Input=1.0V _{P-P}	3.0	5.5	8.0	dB
Brightness variable range (Lo)	BR _{7(L)}	Input=1.0V _{P-P} , V ₇ =0V	—	—	1.7	V
Brightness variable range (Hi)	BR _{7(H)}	Input=1.0V _{P-P} , V ₇ =4.8V	2.8	—	—	V
White balance adjustment Lo	WB _L	Input=1.0V _{P-P} , V ₈ , V ₁₀ =0V	—	—	1.9	V
White balance adjustment Hi	WB _H	Input=1.0V _{P-P} , V ₈ , V ₁₀ =4.8V	2.1	—	—	V
Output signal limiter level (Black side)	V _{RL(B)}	Input=1.0V _{P-P} , V ₁₁ =0V	1.0	1.3	1.6	V
Output signal limiter level (White side)	V _{RL(W)}	Input=1.0V _{P-P} , V ₁₁ =4.8V	13.0	13.7	14.4	V
Output terminal absolute voltage (R ch)	V	Input=1.0V _{P-P}	7.25	7.5	7.75	V
Output terminal absolute voltage (G ch)	V _{17A}	Input=1.0V _{P-P}	7.25	7.5	7.75	V
Output terminal absolute voltage (B ch)	V _{15A}	Input=1.0V _{P-P}	7.25	7.5	7.75	V
Output terminal relative voltage (R ch)	V _{19B}	Input=1.0V _{P-P}	-0.25	0	0.25	V
Output terminal relative voltage (B ch)	V _{15B}	Input=1.0V _{P-P}	-0.25	0	0.25	V

■ Electrical Characteristics [for reference only] (Ta=25±2°C)

Parameter	Symbol	Condition	min	typ	max	Unit
Y→G signal gain	G ₁₇₋₃₉	Input=1.0V _{P-P}	—	13	—	dB
C→R signal gain	GN ₁₉	Input=600mV _{P-P}	—	15	—	dB
C→G signal gain	GN ₁₇	Input=600mV _{P-P}	—	10	—	dB
C→B signal gain	GN ₁₅	Input=600mV _{P-P}	—	16	—	dB
Y→G signal f characteristics	F ₁₇₋₃₉	Input=1.0V _{P-P}	—	-6	—	dB
G ch character level (Lo)	CG _L	Input=1.0V _{P-P}	—	5	—	IRE
G ch character level (Hi)	CG _H	Input=1.0V _{P-P}	—	85	—	IRE

Note) The value in the above characteristics is not a guaranteed value, but reference one on design.

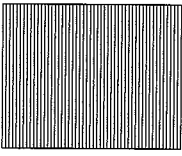
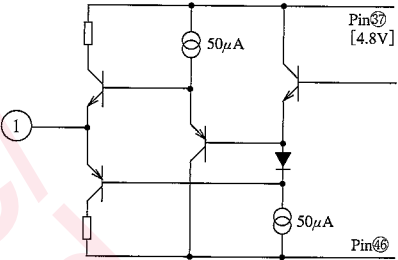
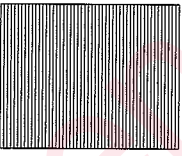
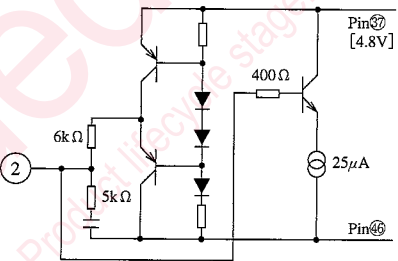
Pin Descriptions

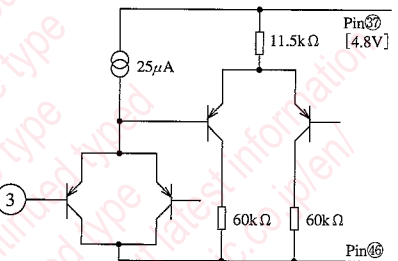
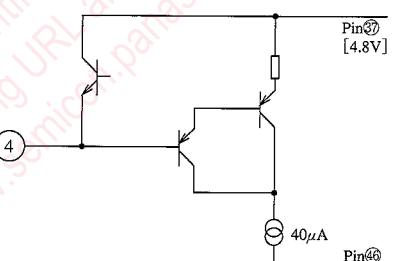
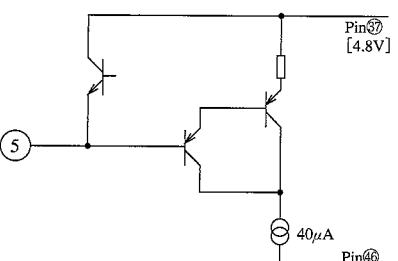
Pin No.	Pin name	Waveform	Description	Equivalent circuit
1	XTAL 1	<p>NTSC 3.58MHz PAL 4.43MHz</p> 	<ul style="list-style-type: none"> To a XTAL Forming a pair of input terminals with Pin② 	
2	XTAL 2	<p>NTSC 3.58MHz PAL 4.43MHz</p> 	<ul style="list-style-type: none"> To a XTAL Forming a pair of input terminals with Pin① 	
3	TINT		<ul style="list-style-type: none"> TINT control input H (more than 2.5V) : PAL L (up to 2.5V) : NTSC 	
4	B-Y CLAMP	<p>0.1 µF</p>	<ul style="list-style-type: none"> To a B-Y clamp capacitor H.SYNC pulse clamps the B-Y signal to the reference voltage 	
5	R-Y CLAMP	<p>0.1 µF</p>	<ul style="list-style-type: none"> To a R-Y clamp capacitor H.SYNC pulse clamps the R-Y signal to the reference voltage 	

ICs for Video Camera

■ Pin Descriptions (cont.)

Pin No.	Pin name	Waveform	Description	Equivalent circuit
6	G-Y CLAMP	0.1 μ F	<ul style="list-style-type: none"> To a R-Y clamp capacitor H.SYNC pulse clamps the G-Y signal to the reference voltage 	
7	BRIGHT	<p>G_{OUT} waveform at Pin 17</p>	<ul style="list-style-type: none"> Brightness control Used to control the pedestal level of R, G, and B outputs at the same time 	
8	WB-R	<p>R_{OUT} waveform at Pin 19</p>	<ul style="list-style-type: none"> R-output white balance control Used to fine-control the pedestal level of R output 2V typ. 	
9	VREF		<ul style="list-style-type: none"> Reference voltage output 2V typ. 	
10	WB-B	<p>B_{OUT} waveform at Pin 15</p>	<ul style="list-style-type: none"> B-output white balance control Used to fine-control the pedestal level of B output 2V typ. 	

■ Pin Descriptions (cont.)

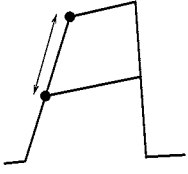
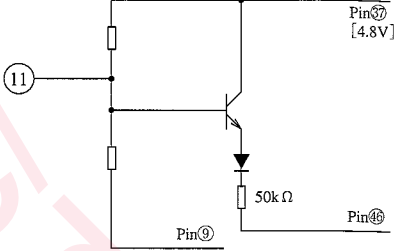
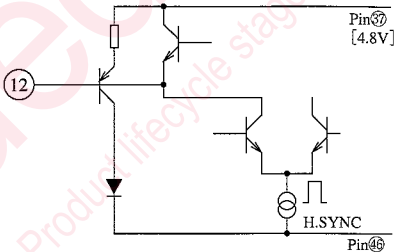
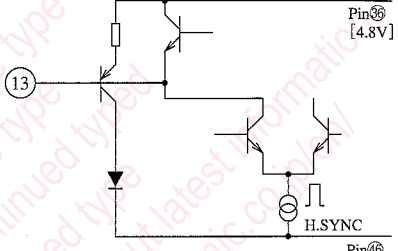
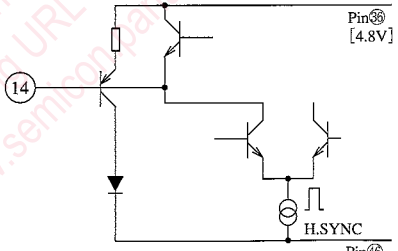
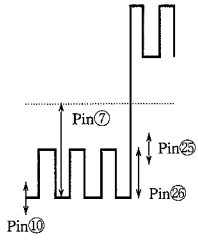
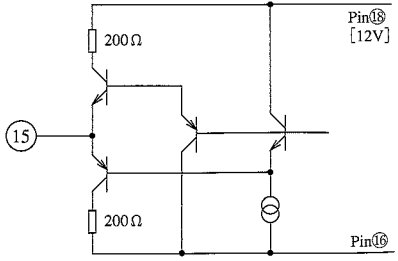
Pin No.	Pin name	Waveform	Description	Equivalent circuit
11	γ CONT		<ul style="list-style-type: none"> • γ characteristics control • Used to control the γ-curve knee point of R, G, and B outputs 	
12	B CLAMP	—	<ul style="list-style-type: none"> • To a B-signal clamp capacitor • 0.1 μF typ. 	
13	G CLAMP	—	<ul style="list-style-type: none"> • To a G-signal clamp capacitor • 0.1 μF typ. 	
14	R CLAMP	—	<ul style="list-style-type: none"> • To a R-signal clamp capacitor • 0.1 μF typ. 	
15	B OUT		<ul style="list-style-type: none"> • B-signal output • 70-Ω output impedance 	

ICs for Video Camera

■ Pin Descriptions (cont.)

Pin No.	Pin name	Waveform	Description	Equivalent circuit
16	GND2		<ul style="list-style-type: none"> Ground for the V_{CC2} (12V) subsystem 	
17	G OUT		<ul style="list-style-type: none"> G-signal output 70-Ω output impedance 	
18	V _{CC2}		<ul style="list-style-type: none"> 12V power supply input Typ. 4mA current consumption 	
19	R OUT		<ul style="list-style-type: none"> R-signal output 70-Ω output impedance 	
20	DC Det.		<ul style="list-style-type: none"> R, G, B output DC voltage stabilizing capacitor pin Used to adjust the center level of G output (and thereby R and B outputs) to 1/2 V_{CC2} 0.1 μF typ. 	

■ Pin Descriptions (cont.)

Pin No.	Pin name	Waveform	Description	Equivalent circuit
26	CONTRAST	G-output waveform at Pin⑰	<ul style="list-style-type: none"> Contrast control Used to control the contrast of R, G, and B output signals at same time 	
27	SUB CONT-R	R-output waveform at Pin⑰	<ul style="list-style-type: none"> Used to fine-control R-output signal contrast 1.8V typ. 	
28	Y-CLAMP	—	<ul style="list-style-type: none"> To a Y-signal clamp capacitor 0.1 μF typ. 	
29	FSP TRAP	—	<ul style="list-style-type: none"> To FSC trap network Not used for component signals For NTSC, C=47pF and L=35 μH For PAL, C=47pF and L=27 μH 	
30	Y-CONT	—	<ul style="list-style-type: none"> Y-signal amplitude control Used to control the amplitude of Y signal which is mixed with R-Y, B-Y, and G-Y V_{REF} typ. 	

Pin Descriptions (cont.)

Pin No.	Pin name	Waveform	Description	Equivalent circuit
31	H-AP GAIN		<ul style="list-style-type: none"> H-AP signal amplitude adjust H-AP signals are amplified, and then mixed with Y signals, and luminance signals are generated V_{REF} typ. 	
32	BGP		<ul style="list-style-type: none"> To a BG pulse generating CR network Delay is determined by C and R 	
33	H-SYNC OUT		<ul style="list-style-type: none"> H.SYNC pulse output H.SYNC is separated from the signal which is input at Pin 33, and is output 	
34	CHA PULSE IN (R)		<ul style="list-style-type: none"> Character pulse (R) input Character with black-frame can be outputted at Pin 19 of R-output by character pulse input 	
35	CHA PULSE IN (G)		<ul style="list-style-type: none"> Character pulse (G) input Character with black frame can be outputted at Pin 17 of G-output 	

ICs for Video Camera

■ Pin Descriptions (cont.)

Pin No.	Pin name	Waveform	Description	Equivalent circuit
36	CHA PULSE IN (B)		<ul style="list-style-type: none"> Character with black-frame can be outputted at G-output by character pulse (B) input-Pin⑬ 	
37	V _{CC1} (4.8V)		<ul style="list-style-type: none"> 4.8V power supply input 20mA typ. current consumption 	
38	HSYNC IN	<p>Input signal example : video signal</p>	<ul style="list-style-type: none"> H.SYNC input Input composite video signal 	
39	Y IN	<p>Input signal example : video signal</p>	<ul style="list-style-type: none"> Luminance signal input Input composite video signal 	
40	C IN	<p>Input signal example : video signal</p>	<ul style="list-style-type: none"> Chroma input Input composite video signal 	

Pin Descriptions (cont.)

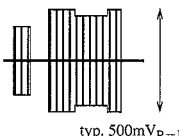
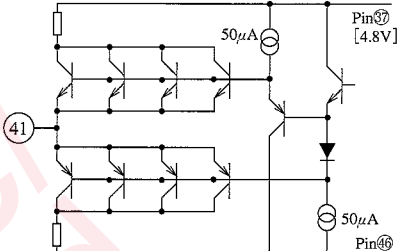
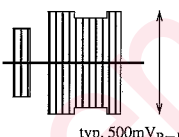
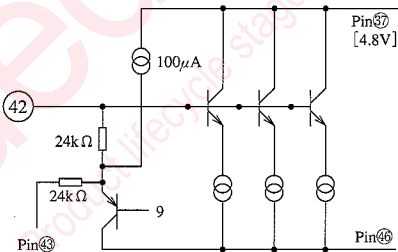
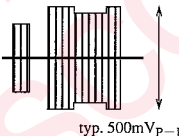
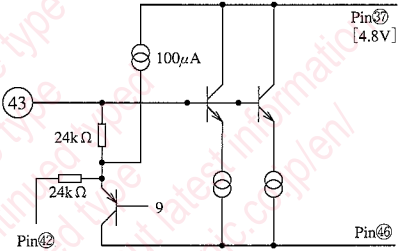
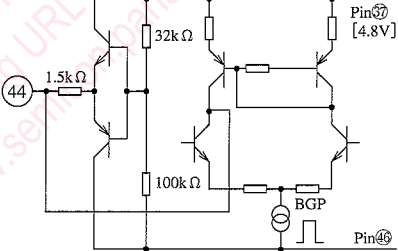
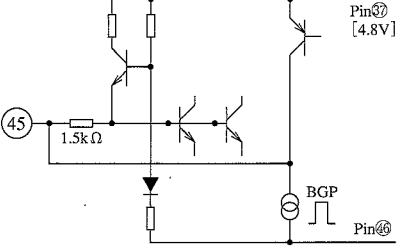
Pin No.	Pin name	Waveform	Description	Equivalent circuit
41	ACC OUT	<p>Output waveform 3.58MHz (4.43MHz)</p>  <p>typ. 500mV_{p-p}</p>	<ul style="list-style-type: none"> • Chroma output through ACC • After being processed in ACC, input chroma signal of Pin④① is outputted. • The output amplitude can be adjusted at Pin②③. • 500mV_{p-p} typ. 	
42	2B + Burst	<p>Input waveform (simplified PAL)</p>  <p>typ. 500mV_{p-p}</p>	<ul style="list-style-type: none"> • 2B + Burst input • For simplified PAL, ACC OUT of Pin④① is inputted to this pin. 	
43	2R	<p>Input waveform (simplified PAL)</p>  <p>typ. 500mV_{p-p}</p>	<ul style="list-style-type: none"> • 2R input • For simplified PAL, ACC OUT of Pin④① is inputted to this pin. 	
44	ACC Det.	<p>0.1 µF</p>	<ul style="list-style-type: none"> • To an ACC capacitor • Used for automatic adjustment of burst signal amplitudes 	
45	KILLER Det.	<p>0.1 µF</p>	<ul style="list-style-type: none"> • To a KILLER capacitor • Used to cut chroma signals, and produce monochrome images for preventing the image-deterioration, when burst signal amplitude is low 	

ICs for Video Camera

■ Pin Descriptions (cont.)

Pin No.	Pin name	Waveform	Description	Equivalent circuit
46	GND1	————	<ul style="list-style-type: none"> Ground for V_{CC1} system (4.8V) 	————
47	APC Det.	0.1 μ F	<ul style="list-style-type: none"> To APC capacitor Used to match the phase of crystal oscillation with that of burst signals 	
48	HALF H	————	<ul style="list-style-type: none"> To CR network for HALF H. KILLER Used for HALF H operation when PAL signals are inputted 	

■ Reference

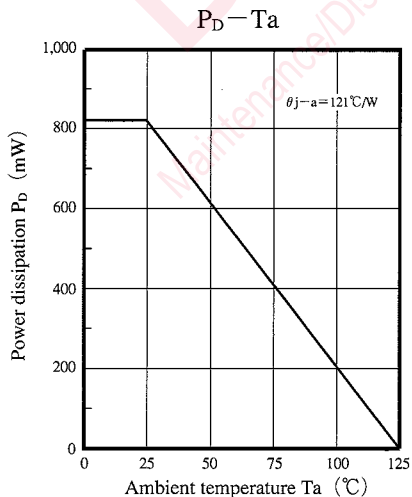

Request for your special attention and precautions in using the technical information and semiconductors described in this book

- (1) If any of the products or technical information described in this book is to be exported or provided to non-residents, the laws and regulations of the exporting country, especially, those with regard to security export control, must be observed.
- (2) The technical information described in this book is intended only to show the main characteristics and application circuit examples of the products. No license is granted in and to any intellectual property right or other right owned by Panasonic Corporation or any other company. Therefore, no responsibility is assumed by our company as to the infringement upon any such right owned by any other company which may arise as a result of the use of technical information described in this book.
- (3) The products described in this book are intended to be used for standard applications or general electronic equipment (such as office equipment, communications equipment, measuring instruments and household appliances).
Consult our sales staff in advance for information on the following applications:
 - Special applications (such as for airplanes, aerospace, automobiles, traffic control equipment, combustion equipment, life support systems and safety devices) in which exceptional quality and reliability are required, or if the failure or malfunction of the products may directly jeopardize life or harm the human body.
 - Any applications other than the standard applications intended.
- (4) The products and product specifications described in this book are subject to change without notice for modification and/or improvement. At the final stage of your design, purchasing, or use of the products, therefore, ask for the most up-to-date Product Standards in advance to make sure that the latest specifications satisfy your requirements.
- (5) When designing your equipment, comply with the range of absolute maximum rating and the guaranteed operating conditions (operating power supply voltage and operating environment etc.). Especially, please be careful not to exceed the range of absolute maximum rating on the transient state, such as power-on, power-off and mode-switching. Otherwise, we will not be liable for any defect which may arise later in your equipment.
 - Even when the products are used within the guaranteed values, take into the consideration of incidence of break down and failure mode, possible to occur to semiconductor products. Measures on the systems such as redundant design, arresting the spread of fire or preventing glitch are recommended in order to prevent physical injury, fire, social damages, for example, by using the products.
- (6) Comply with the instructions for use in order to prevent breakdown and characteristics change due to external factors (ESD, EOS, thermal stress and mechanical stress) at the time of handling, mounting or at customer's process. When using products for which damp-proof packing is required, satisfy the conditions, such as shelf life and the elapsed time since first opening the packages.
- (7) This book may be not reprinted or reproduced whether wholly or partially, without the prior written permission of our company.