

# AN78xxR/AN78MxxR Series

4-pin positive output voltage regulator with reset pin (1 A/500 mA type)

## ■ Overview

The AN78xxR series and the AN78MxxR series are the fixed positive output type monolithic voltage regulators with reset pin. Stabilized fixed output voltage is obtained from unstable DC input voltage without using any external components. Three types of output voltage, 5V, 9V and 12V, are available for the AN78xxR series, and four types, 5V, 8V, 9V and 12V, are available for the AN78MxxR series. They can be used in power circuits with current capacity of 1A/500mA. On/off of output voltage can be controlled by the reset pin.

## ■ Features

- No external components
- Maximum output current: 1A (AN78xxR)  
500mA (AN78MxxR)
- Output voltage: 5V, 9V, 12V (AN78xxR)  
5V, 8V, 9V, 12V (AN78MxxR)
- Built-in overcurrent limit circuit
- Built-in thermal overload protection circuit
- Built-in ASO (area of safe operation) protection circuit
- On/off of output voltage can be controlled by reset pin

## ■ Block Diagram

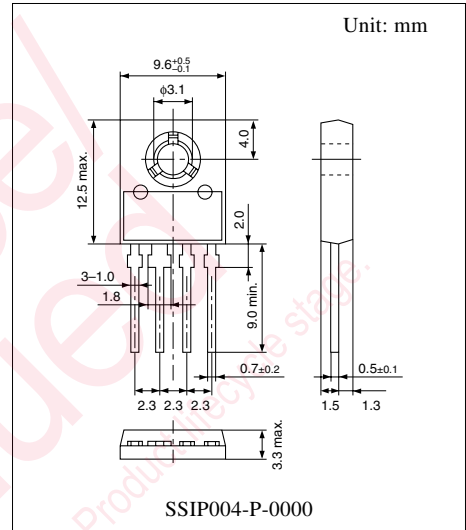
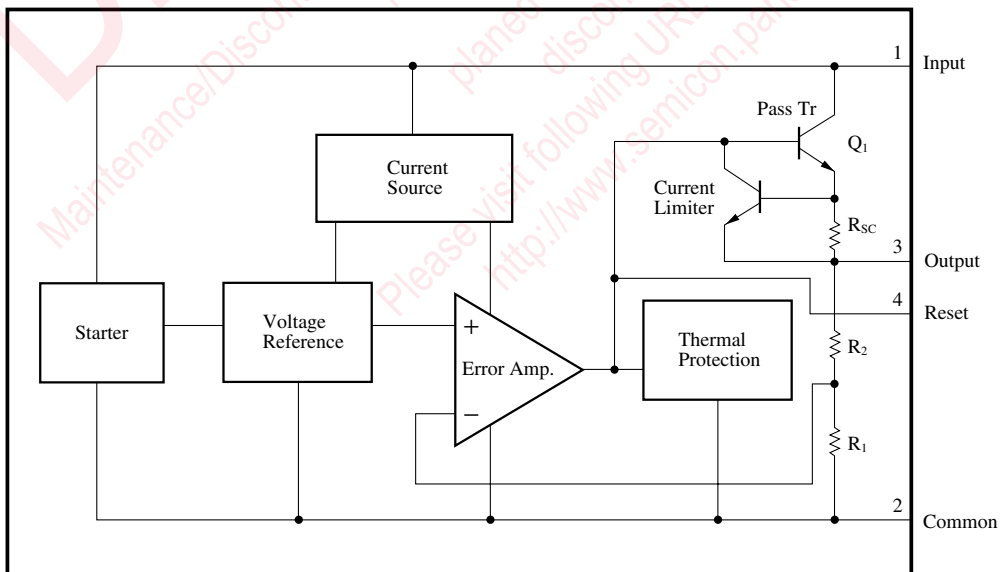

### ■ Absolute Maximum Ratings at $T_a = 25^\circ\text{C}$

Parameter	Symbol	Rating	Unit
Input voltage	$V_I$	35	V
Power dissipation	$P_D$	10 *	W
Operating ambient temperature	$T_{opr}$	-20 to +80	$^\circ\text{C}$
Storage temperature	$T_{stg}$	-55 to +150	$^\circ\text{C}$

\* Follow the derating curve. When  $T_j$  exceeds  $150^\circ\text{C}$ , the internal circuit cuts off the output.

### ■ Electrical Characteristics at $T_a = 25^\circ\text{C}$

[1] AN78xxR series

• AN7805R (1A, 5V type)

Parameter	Symbol	Conditions	Min	Typ	Max	Unit
Output voltage	$V_O$	$T_j = 25^\circ\text{C}$	4.8	5	5.2	V
Output voltage tolerance	$V_O$	$V_I = 8$ to $20\text{V}$ , $I_O = 5\text{mA}$ to $1\text{A}$ , $T_j = 0$ to $125^\circ\text{C}$ , $P_D \leq 15\text{W}$	4.75	—	5.25	V
Line regulation	$\text{REG}_{IN}$	$V_I = 7.5$ to $25\text{V}$ , $T_j = 25^\circ\text{C}$	—	3	100	mV
		$V_I = 8$ to $12\text{V}$ , $T_j = 25^\circ\text{C}$	—	1	50	mV
Load regulation	$\text{REG}_L$	$I_O = 5\text{mA}$ to $1.5\text{A}$ , $T_j = 25^\circ\text{C}$	—	15	100	mV
		$I_O = 250$ to $750\text{mA}$ , $T_j = 25^\circ\text{C}$	—	5	50	mV
Bias current	$I_{Bias}$	$T_j = 25^\circ\text{C}$	—	3.9	8	mA
Bias current fluctuation to input	$\Delta I_{Bias(IN)}$	$V_I = 7.5$ to $25\text{V}$ , $T_j = 25^\circ\text{C}$	—	—	1.3	mA
Bias current fluctuation to load	$\Delta I_{Bias(L)}$	$I_O = 5\text{mA}$ to $1\text{A}$ , $T_j = 25^\circ\text{C}$	—	—	0.5	mA
Output noise voltage	$V_{no}$	$f = 10\text{Hz}$ to $100\text{kHz}$	—	40	—	$\mu\text{V}$
Ripple rejection ratio	RR	$V_I = 8$ to $18\text{V}$ , $I_O = 100\text{mA}$ , $f = 120\text{Hz}$	62	—	—	dB
Minimum input/output voltage difference	$V_{DIF(min)}$	$I_O = 1\text{A}$ , $T_j = 25^\circ\text{C}$	—	2	—	V
Output impedance	$Z_O$	$f = 1\text{kHz}$	—	17	—	$\text{m}\Omega$
Output short-circuit current	$I_{O(Short)}$	$V_I = 35\text{V}$ , $T_j = 25^\circ\text{C}$	—	700	—	mA
Peak output current	$I_{O(Peak)}$	$T_j = 25^\circ\text{C}$	—	2	—	A
Output voltage temperature coefficient	$\Delta V_O/T_a$	$I_O = 5\text{mA}$ , $T_j = 0$ to $125^\circ\text{C}$	—	-0.3	—	$\text{mV}/^\circ\text{C}$
Output voltage at reset	$V_{O(Reset)}$	$T_j = 25^\circ\text{C}$ , $I_{I(Reset)} = 1\text{mA}$	—	—	1	V
Reset input current	$I_{I(Reset)}$	$T_j = 25^\circ\text{C}$	—	—	1	mA

Note 1) The specified condition  $T_j = 25^\circ\text{C}$  means that the test should be carried out within so short a test time (within 10ms) that the characteristic value drift due to the chip junction temperature rise can be ignored.

Note 2) Unless otherwise specified,  $V_I = 10\text{V}$ ,  $I_O = 500\text{mA}$ ,  $C_I = 0.33\mu\text{F}$ ,  $C_O = 0.1\mu\text{F}$  and  $T_j = 0$  to  $125^\circ\text{C}$

### ■ Electrical Characteristics at $T_a = 25^\circ\text{C}$ (continued)

#### • AN7809R (1A, 9V type)

Parameter	Symbol	Conditions	Min	Typ	Max	Unit
Output voltage	$V_O$	$T_j = 25^\circ\text{C}$	8.65	9	9.35	V
Output voltage tolerance	$V_O$	$V_I = 12$ to $24\text{V}$ , $I_O = 5\text{mA}$ to $1\text{A}$ , $T_j = 0$ to $125^\circ\text{C}$ , $P_D \leq 15\text{W}$	8.55	—	9.45	V
Line regulation	REG <sub>IN</sub>	$V_I = 11.5$ to $26\text{V}$ , $T_j = 25^\circ\text{C}$	—	7	180	mV
		$V_I = 12$ to $18\text{V}$ , $T_j = 25^\circ\text{C}$	—	2	90	mV
Load regulation	REG <sub>L</sub>	$I_O = 5\text{mA}$ to $1.5\text{A}$ , $T_j = 25^\circ\text{C}$	—	12	180	mV
		$I_O = 250$ to $750\text{mA}$ , $T_j = 25^\circ\text{C}$	—	4	90	mV
Bias current	$I_{\text{Bias}}$	$T_j = 25^\circ\text{C}$	—	3.9	8	mA
Bias current fluctuation to input	$\Delta I_{\text{Bias(IN)}}$	$V_I = 11.5$ to $26\text{V}$ , $T_j = 25^\circ\text{C}$	—	—	1	mA
Bias current fluctuation to load	$\Delta I_{\text{Bias(L)}}$	$I_O = 5\text{mA}$ to $1\text{A}$ , $T_j = 25^\circ\text{C}$	—	—	0.5	mA
Output noise voltage	$V_{\text{no}}$	$f = 10\text{Hz}$ to $100\text{kHz}$	—	57	—	$\mu\text{V}$
Ripple rejection ratio	RR	$V_I = 12$ to $22\text{V}$ , $I_O = 100\text{mA}$ , $f = 120\text{Hz}$	56	—	—	dB
Minimum input/output voltage difference	$V_{\text{DIF(min)}}$	$I_O = 1\text{A}$ , $T_j = 25^\circ\text{C}$	—	2	—	V
Output impedance	$Z_O$	$f = 1\text{kHz}$	—	16	—	$\text{m}\Omega$
Output short-circuit current	$I_{\text{O(Short)}}$	$V_I = 26\text{V}$ , $T_j = 25^\circ\text{C}$	—	700	—	mA
Peak output current	$I_{\text{O(Peak)}}$	$T_j = 25^\circ\text{C}$	—	2	—	A
Output voltage temperature coefficient	$\Delta V_O/T_a$	$I_O = 5\text{mA}$ , $T_j = 0$ to $125^\circ\text{C}$	—	-0.5	—	$\text{mV}/^\circ\text{C}$
Output voltage at reset	$V_{\text{O(Reset)}}$	$T_j = 25^\circ\text{C}$ , $I_{\text{I(Reset)}} = 1\text{mA}$	—	—	1	V
Reset input current	$I_{\text{I(Reset)}}$	$T_j = 25^\circ\text{C}$	—	—	1	mA

Note 1) The specified condition  $T_j = 25^\circ\text{C}$  means that the test should be carried out within so short a test time (within 10ms) that the characteristic value drift due to the chip junction temperature rise can be ignored.

Note 2) Unless otherwise specified,  $V_I = 15\text{V}$ ,  $I_O = 500\text{mA}$ ,  $C_I = 0.33\mu\text{F}$ ,  $C_O = 0.1\mu\text{F}$  and  $T_j = 0$  to  $125^\circ\text{C}$

#### • AN7812R (1A, 12V type)

Parameter	Symbol	Conditions	Min	Typ	Max	Unit
Output voltage	$V_O$	$T_j = 25^\circ\text{C}$	11.5	12	12.5	V
Output voltage tolerance	$V_O$	$V_I = 15$ to $27\text{V}$ , $I_O = 5\text{mA}$ to $1\text{A}$ , $T_j = 0$ to $125^\circ\text{C}$ , $P_D \leq 15\text{W}$	11.4	—	12.6	V
Line regulation	REG <sub>IN</sub>	$V_I = 14.5$ to $30\text{V}$ , $T_j = 25^\circ\text{C}$	—	10	240	mV
		$V_I = 16$ to $22\text{V}$ , $T_j = 25^\circ\text{C}$	—	3	120	mV
Load regulation	REG <sub>L</sub>	$I_O = 5\text{mA}$ to $1.5\text{A}$ , $T_j = 25^\circ\text{C}$	—	12	240	mV
		$I_O = 250$ to $750\text{mA}$ , $T_j = 25^\circ\text{C}$	—	4	120	mV
Bias current	$I_{\text{Bias}}$	$T_j = 25^\circ\text{C}$	—	4	8	mA
Bias current fluctuation to input	$\Delta I_{\text{Bias(IN)}}$	$V_I = 14.5$ to $30\text{V}$ , $T_j = 25^\circ\text{C}$	—	—	1	mA
Bias current fluctuation to load	$\Delta I_{\text{Bias(L)}}$	$I_O = 5\text{mA}$ to $1\text{A}$ , $T_j = 25^\circ\text{C}$	—	—	0.5	mA
Output noise voltage	$V_{\text{no}}$	$f = 10\text{Hz}$ to $100\text{kHz}$	—	75	—	$\mu\text{V}$
Ripple rejection ratio	RR	$V_I = 15$ to $25\text{V}$ , $I_O = 100\text{mA}$ , $f = 120\text{Hz}$	55	—	—	dB
Minimum input/output voltage difference	$V_{\text{DIF(min)}}$	$I_O = 1\text{A}$ , $T_j = 25^\circ\text{C}$	—	2	—	V
Output impedance	$Z_O$	$f = 1\text{kHz}$	—	18	—	$\text{m}\Omega$
Output short-circuit current	$I_{\text{O(Short)}}$	$V_I = 35\text{V}$ , $T_j = 25^\circ\text{C}$	—	700	—	mA
Peak output current	$I_{\text{O(Peak)}}$	$T_j = 25^\circ\text{C}$	—	2	—	A
Output voltage temperature coefficient	$\Delta V_O/T_a$	$I_O = 5\text{mA}$ , $T_j = 0$ to $125^\circ\text{C}$	—	-0.8	—	$\text{mV}/^\circ\text{C}$
Output voltage at reset	$V_{\text{O(Reset)}}$	$T_j = 25^\circ\text{C}$ , $I_{\text{I(Reset)}} = 1\text{mA}$	—	—	1	V
Reset input current	$I_{\text{I(Reset)}}$	$T_j = 25^\circ\text{C}$	—	—	1	mA

Note 1) The specified condition  $T_j = 25^\circ\text{C}$  means that the test should be carried out within so short a test time (within 10ms) that the characteristic value drift due to the chip junction temperature rise can be ignored.

Note 2) Unless otherwise specified,  $V_I = 19\text{V}$ ,  $I_O = 500\text{mA}$ ,  $C_I = 0.33\mu\text{F}$ ,  $C_O = 0.1\mu\text{F}$  and  $T_j = 0$  to  $125^\circ\text{C}$

■ Electrical Characteristics at  $T_a = 25^\circ\text{C}$  (continued)

[2] AN78MxxR series

• AN78M05R (500mA, 5V type)

Parameter	Symbol	Conditions	Min	Typ	Max	Unit
Output voltage	$V_O$	$T_j = 25^\circ\text{C}$	4.8	5	5.2	V
Output voltage tolerance	$V_O$	$V_I = 7.5$ to 20V, $I_O = 5$ to 350mA, $T_j = 0$ to $125^\circ\text{C}$ , $P_D \leq 15\text{W}$	4.75	—	5.25	V
Line regulation	REG <sub>IN</sub>	$V_I = 7.5$ to 25V, $T_j = 25^\circ\text{C}$	—	3	100	mV
		$V_I = 8$ to 25V, $T_j = 25^\circ\text{C}$	—	1	50	mV
Load regulation	REG <sub>L</sub>	$I_O = 5$ to 500mA, $T_j = 25^\circ\text{C}$	—	20	100	mV
		$I_O = 5$ to 200mA, $T_j = 25^\circ\text{C}$	—	10	50	mV
Bias current	$I_{\text{Bias}}$	$T_j = 25^\circ\text{C}$	—	4.6	6	mA
Bias current fluctuation to input	$\Delta I_{\text{Bias(IN)}}$	$V_I = 8$ to 25V, $T_j = 25^\circ\text{C}$	—	—	0.8	mA
Bias current fluctuation to load	$\Delta I_{\text{Bias(L)}}$	$I_O = 5$ to 350mA, $T_j = 25^\circ\text{C}$	—	—	0.5	mA
Output noise voltage	$V_{\text{no}}$	$f = 10\text{Hz}$ to 100kHz	—	40	—	$\mu\text{V}$
Ripple rejection ratio	RR	$V_I = 8$ to 18V, $I_O = 100\text{mA}$ , $f = 120\text{Hz}$	62	—	—	dB
Minimum input/output voltage difference	$V_{\text{DIF(min)}}$	$I_O = 500\text{mA}$ , $T_j = 25^\circ\text{C}$	—	2	—	V
Output short-circuit current	$I_{\text{O(Short)}}$	$V_I = 35\text{V}$ , $T_j = 25^\circ\text{C}$	—	300	—	mA
Peak output current	$I_{\text{O(Peak)}}$	$T_j = 25^\circ\text{C}$	—	700	—	mA
Output voltage temperature coefficient	$\Delta V_O/T_a$	$I_O = 5\text{mA}$ , $T_j = 0$ to $125^\circ\text{C}$	—	-0.5	—	$\text{mV}/^\circ\text{C}$
Output voltage at reset	$V_{\text{O(Reset)}}$	$T_j = 25^\circ\text{C}$ , $I_{\text{I(Reset)}} = 1\text{mA}$	—	—	1	V
Reset input current	$I_{\text{I(Reset)}}$	$T_j = 25^\circ\text{C}$	—	—	1	mA

Note 1) The specified condition  $T_j = 25^\circ\text{C}$  means that the test should be carried out within so short a test time (within 10ms) that the characteristic value drift due to the chip junction temperature rise can be ignored.

Note 2) Unless otherwise specified,  $V_I = 10\text{V}$ ,  $I_O = 350\text{mA}$ ,  $C_I = 0.33\mu\text{F}$ ,  $C_O = 0.1\mu\text{F}$  and  $T_j = 0$  to  $125^\circ\text{C}$

• AN78M08R (500mA, 8V type)

Parameter	Symbol	Conditions	Min	Typ	Max	Unit
Output voltage	$V_O$	$T_j = 25^\circ\text{C}$	7.7	8	8.3	V
Output voltage tolerance	$V_O$	$V_I = 10.5$ to 23V, $I_O = 5$ to 350mA, $T_j = 0$ to $125^\circ\text{C}$ , $P_D \leq 15\text{W}$	7.6	—	8.4	V
Line regulation	REG <sub>IN</sub>	$V_I = 10.5$ to 25V, $T_j = 25^\circ\text{C}$	—	6	100	mV
		$V_I = 11$ to 25V, $T_j = 25^\circ\text{C}$	—	2	50	mV
Load regulation	REG <sub>L</sub>	$I_O = 5$ to 500mA, $T_j = 25^\circ\text{C}$	—	25	160	mV
		$I_O = 5$ to 200mA, $T_j = 25^\circ\text{C}$	—	10	80	mV
Bias current	$I_{\text{Bias}}$	$T_j = 25^\circ\text{C}$	—	4.1	6	mA
Bias current fluctuation to input	$\Delta I_{\text{Bias(IN)}}$	$V_I = 10.5$ to 25V, $T_j = 25^\circ\text{C}$	—	—	0.8	mA
Bias current fluctuation to load	$\Delta I_{\text{Bias(L)}}$	$I_O = 5$ to 350mA, $T_j = 25^\circ\text{C}$	—	—	0.5	mA
Output noise voltage	$V_{\text{no}}$	$f = 10\text{Hz}$ to 100kHz	—	52	—	$\mu\text{V}$
Ripple rejection ratio	RR	$V_I = 11.5$ to 21.5V, $I_O = 100\text{mA}$ , $f = 120\text{Hz}$	56	—	—	dB
Minimum input/output voltage difference	$V_{\text{DIF(min)}}$	$I_O = 500\text{mA}$ , $T_j = 25^\circ\text{C}$	—	2	—	V
Output short-circuit current	$I_{\text{O(Short)}}$	$V_I = 35\text{V}$ , $T_j = 25^\circ\text{C}$	—	300	—	mA
Peak output current	$I_{\text{O(Peak)}}$	$T_j = 25^\circ\text{C}$	—	0.7	—	A
Output voltage temperature coefficient	$\Delta V_O/T_a$	$I_O = 5\text{mA}$ , $T_j = 0$ to $125^\circ\text{C}$	—	-0.5	—	$\text{mV}/^\circ\text{C}$
Output voltage at reset	$V_{\text{O(Reset)}}$	$T_j = 25^\circ\text{C}$ , $I_{\text{I(Reset)}} = 1\text{mA}$	—	—	1	V
Reset input current	$I_{\text{I(Reset)}}$	$T_j = 25^\circ\text{C}$	—	—	1	mA

Note 1) The specified condition  $T_j = 25^\circ\text{C}$  means that the test should be carried out within so short a test time (within 10ms) that the characteristic value drift due to the chip junction temperature rise can be ignored.

Note 2) Unless otherwise specified,  $V_I = 14\text{V}$ ,  $I_O = 350\text{mA}$ ,  $C_I = 0.33\mu\text{F}$ ,  $C_O = 0.1\mu\text{F}$  and  $T_j = 0$  to  $125^\circ\text{C}$

■ Electrical Characteristics at  $T_a = 25^\circ\text{C}$  (continued)

• AN78M09R (500mA, 9V type)

Parameter	Symbol	Conditions	Min	Typ	Max	Unit
Output voltage	$V_O$	$T_j = 25^\circ\text{C}$	8.65	9	9.35	V
Output voltage tolerance	$V_O$	$V_I = 11.5$ to $24\text{V}$ , $I_O = 5$ to $350\text{mA}$ , $T_j = 0$ to $125^\circ\text{C}$ , $P_D \leq 15\text{W}$	8.55	—	9.45	V
Line regulation	$\text{REG}_{\text{IN}}$	$V_I = 11.5$ to $25\text{V}$ , $T_j = 25^\circ\text{C}$	—	7	100	mV
		$V_I = 12$ to $25\text{V}$ , $T_j = 25^\circ\text{C}$	—	2	50	mV
Load regulation	$\text{REG}_{\text{L}}$	$I_O = 5$ to $500\text{mA}$ , $T_j = 25^\circ\text{C}$	—	25	180	mV
		$I_O = 5$ to $200\text{mA}$ , $T_j = 25^\circ\text{C}$	—	10	90	mV
Bias current	$I_{\text{Bias}}$	$T_j = 25^\circ\text{C}$	—	4.1	6.0	mA
Bias current fluctuation to input	$\Delta I_{\text{Bias(IN)}}$	$V_I = 12$ to $25\text{V}$ , $T_j = 25^\circ\text{C}$	—	—	0.8	mA
Bias current fluctuation to load	$\Delta I_{\text{Bias(L)}}$	$I_O = 5$ to $350\text{mA}$ , $T_j = 25^\circ\text{C}$	—	—	0.5	mA
Output noise voltage	$V_{\text{no}}$	$f = 10\text{Hz}$ to $100\text{kHz}$	—	60	—	$\mu\text{V}$
Ripple rejection ratio	RR	$V_I = 12$ to $22\text{V}$ , $I_O = 100\text{mA}$ , $f = 120\text{Hz}$	56	—	—	dB
Minimum input/output voltage difference	$V_{\text{DIF(min)}}$	$I_O = 500\text{mA}$ , $T_j = 25^\circ\text{C}$	—	2	—	V
Output short-circuit current	$I_{\text{O(Short)}}$	$V_I = 35\text{V}$ , $T_j = 25^\circ\text{C}$	—	300	—	mA
Peak output current	$I_{\text{O(Peak)}}$	$T_j = 25^\circ\text{C}$	—	0.7	—	A
Output voltage temperature coefficient	$\Delta V_O/T_a$	$I_O = 5\text{mA}$ , $T_j = 0$ to $125^\circ\text{C}$	—	-0.5	—	$\text{mV}/^\circ\text{C}$
Output voltage at reset	$V_{\text{O(Reset)}}$	$T_j = 25^\circ\text{C}$ , $I_{\text{I(Reset)}} = 1\text{mA}$	—	—	1	V
Reset input current	$I_{\text{I(Reset)}}$	$T_j = 25^\circ\text{C}$	—	—	1	mA

Note 1) The specified condition  $T_j = 25^\circ\text{C}$  means that the test should be carried out within so short a test time (within 10ms) that the characteristic value drift due to the chip junction temperature rise can be ignored.

Note 2) Unless otherwise specified,  $V_I = 15\text{V}$ ,  $I_O = 350\text{mA}$ ,  $C_I = 0.33\mu\text{F}$ ,  $C_O = 0.1\mu\text{F}$  and  $T_j = 0$  to  $125^\circ\text{C}$

• AN78M12R (500mA, 12V type)

Parameter	Symbol	Conditions	Min	Typ	Max	Unit
Output voltage	$V_O$	$T_j = 25^\circ\text{C}$	11.5	12	12.5	V
Output voltage tolerance	$V_O$	$V_I = 14.5$ to $27\text{V}$ , $I_O = 5$ to $350\text{mA}$ , $T_j = 0$ to $125^\circ\text{C}$ , $P_D \leq 15\text{W}$	11.4	—	12.6	V
Line regulation	$\text{REG}_{\text{IN}}$	$V_I = 14.5$ to $30\text{V}$ , $T_j = 25^\circ\text{C}$	—	8	100	mV
		$V_I = 16$ to $30\text{V}$ , $T_j = 25^\circ\text{C}$	—	2	50	mV
Load regulation	$\text{REG}_{\text{L}}$	$I_O = 5$ to $500\text{mA}$ , $T_j = 25^\circ\text{C}$	—	25	240	mV
		$I_O = 5$ to $200\text{mA}$ , $T_j = 25^\circ\text{C}$	—	10	120	mV
Bias current	$I_{\text{Bias}}$	$T_j = 25^\circ\text{C}$	—	4.3	6	mA
Bias current fluctuation to input	$\Delta I_{\text{Bias(IN)}}$	$V_I = 14.5$ to $30\text{V}$ , $T_j = 25^\circ\text{C}$	—	—	0.8	mA
Bias current fluctuation to load	$\Delta I_{\text{Bias(L)}}$	$I_O = 5$ to $350\text{mA}$ , $T_j = 25^\circ\text{C}$	—	—	0.5	mA
Output noise voltage	$V_{\text{no}}$	$f = 10\text{Hz}$ to $100\text{kHz}$	—	75	—	$\mu\text{V}$
Ripple rejection ratio	RR	$V_I = 15$ to $25\text{V}$ , $I_O = 100\text{mA}$ , $f = 120\text{Hz}$	55	—	—	dB
Minimum input/output voltage difference	$V_{\text{DIF(min)}}$	$I_O = 500\text{mA}$ , $T_j = 25^\circ\text{C}$	—	2	—	V
Output short-circuit current	$I_{\text{O(Short)}}$	$V_I = 35\text{V}$ , $T_j = 25^\circ\text{C}$	—	300	—	mA
Peak output current	$I_{\text{O(Peak)}}$	$T_j = 25^\circ\text{C}$ , $V_I = 35\text{V}$	—	700	—	mA
Output voltage temperature coefficient	$\Delta V_O/T_a$	$I_O = 5\text{mA}$ , $T_j = 0$ to $125^\circ\text{C}$	—	-0.5	—	$\text{mV}/^\circ\text{C}$
Output voltage at reset	$V_{\text{O(Reset)}}$	$T_j = 25^\circ\text{C}$ , $I_{\text{I(Reset)}} = 1\text{mA}$	—	—	1	V
Reset input current	$I_{\text{I(Reset)}}$	$T_j = 25^\circ\text{C}$	—	—	1	mA

Note 1) The specified condition  $T_j = 25^\circ\text{C}$  means that the test should be carried out within so short a test time (within 10ms) that the characteristic value drift due to the chip junction temperature rise can be ignored.

Note 2) Unless otherwise specified,  $V_I = 19\text{V}$ ,  $I_O = 350\text{mA}$ ,  $C_I = 0.33\mu\text{F}$ ,  $C_O = 0.1\mu\text{F}$  and  $T_j = 0$  to  $125^\circ\text{C}$

■ Main Characteristics

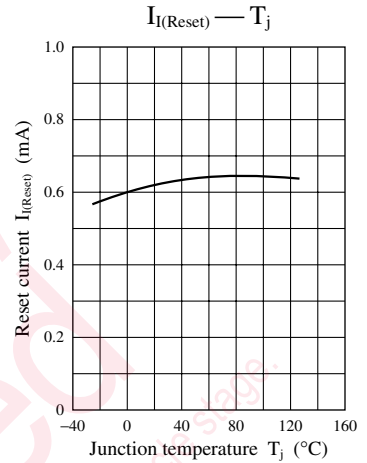
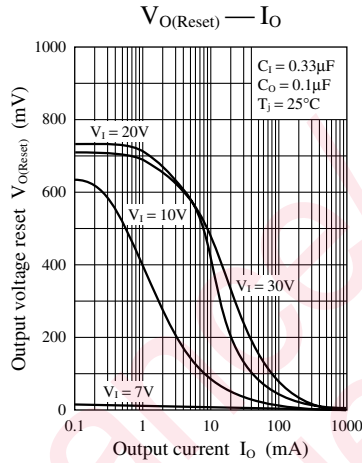
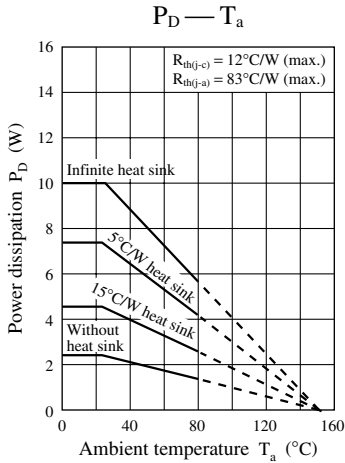

■ Basic Regulator Circuit

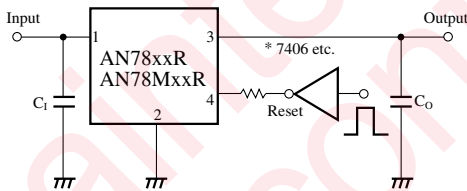

\* For TTL, an open collector type inverter, buffer, gate etc. can be used.

Beware of the breakdown of TTL, as the reset pin bears voltage higher than the output voltage  $V_O$  by 1 to 2V.

$C_1$  is necessary when the input line is long.  
 $C_O$  improves the transient response.

■ Application Circuit Example

1. Soft start circuit

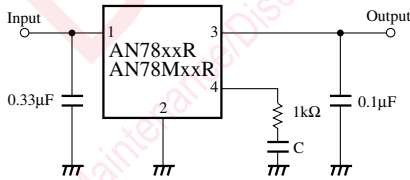

\* Control of output voltage rise time

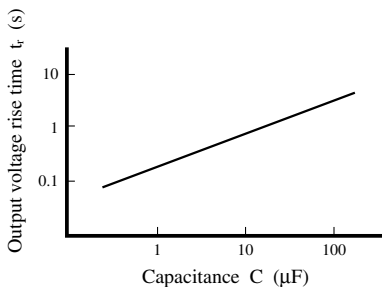

2. Several output reset circuits

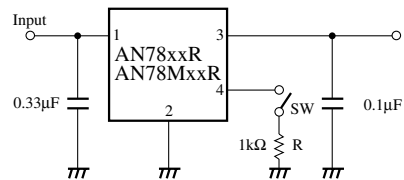
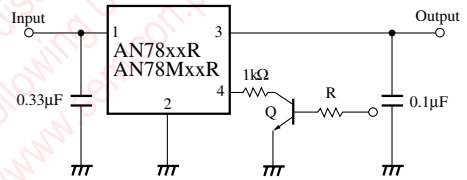

## Request for your special attention and precautions in using the technical information and semiconductors described in this book

- (1) If any of the products or technical information described in this book is to be exported or provided to non-residents, the laws and regulations of the exporting country, especially, those with regard to security export control, must be observed.
- (2) The technical information described in this book is intended only to show the main characteristics and application circuit examples of the products, and no license is granted under any intellectual property right or other right owned by our company or any other company. Therefore, no responsibility is assumed by our company as to the infringement upon any such right owned by any other company which may arise as a result of the use of technical information described in this book.
- (3) The products described in this book are intended to be used for standard applications or general electronic equipment (such as office equipment, communications equipment, measuring instruments and household appliances).  
Consult our sales staff in advance for information on the following applications:
  - Special applications (such as for airplanes, aerospace, automobiles, traffic control equipment, combustion equipment, life support systems and safety devices) in which exceptional quality and reliability are required, or if the failure or malfunction of the products may directly jeopardize life or harm the human body.
  - Any applications other than the standard applications intended.
- (4) The products and product specifications described in this book are subject to change without notice for modification and/or improvement. At the final stage of your design, purchasing, or use of the products, therefore, ask for the most up-to-date Product Standards in advance to make sure that the latest specifications satisfy your requirements.
- (5) When designing your equipment, comply with the range of absolute maximum rating and the guaranteed operating conditions (operating power supply voltage and operating environment etc.). Especially, please be careful not to exceed the range of absolute maximum rating on the transient state, such as power-on, power-off and mode-switching. Otherwise, we will not be liable for any defect which may arise later in your equipment.
  - Even when the products are used within the guaranteed values, take into the consideration of incidence of break down and failure mode, possible to occur to semiconductor products. Measures on the systems such as redundant design, arresting the spread of fire or preventing glitch are recommended in order to prevent physical injury, fire, social damages, for example, by using the products.
- (6) Comply with the instructions for use in order to prevent breakdown and characteristics change due to external factors (ESD, EOS, thermal stress and mechanical stress) at the time of handling, mounting or at customer's process. When using products for which damp-proof packing is required, satisfy the conditions, such as shelf life and the elapsed time since first opening the packages.
- (7) This book may be not reprinted or reproduced whether wholly or partially, without the prior written permission of Matsushita Electric Industrial Co., Ltd.