

# FDA18N50

## N-Channel UniFET™ MOSFET

### 500 V, 19 A, 265 mΩ



FDA18N50 N-Channel UniFET™ MOSFET

#### Features

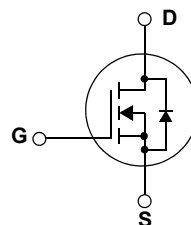
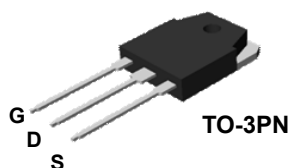
- $R_{DS(on)} = 265 \text{ m}\Omega$  (Max.) @  $V_{GS} = 10 \text{ V}$ ,  $I_D = 9.5 \text{ A}$
- Low Gate Charge (Typ. 45 nC)
- Low  $C_{rss}$  (Typ. 25 pF)
- 100% Avalanche Tested

#### Description

UniFET™ MOSFET is Fairchild Semiconductor®'s high voltage MOSFET family based on planar stripe and DMOS technology. This MOSFET is tailored to reduce on-state resistance, and to provide better switching performance and higher avalanche energy strength. This device family is suitable for switching power converter applications such as power factor correction (PFC), flat panel display (FPD) TV power, ATX and electronic lamp ballasts.

#### Applications

- PDP TV
- Uninterruptible Power Supply
- AC-DC Power Supply



#### Absolute Maximum Ratings

Symbol	Parameter	FDA18N50	Unit
$V_{DSS}$	Drain-Source Voltage	500	V
$I_D$	Drain Current	- Continuous ( $T_C = 25^\circ\text{C}$ )	19
		- Continuous ( $T_C = 100^\circ\text{C}$ )	11.4
$I_{DM}$	Drain Current	- Pulsed (Note 1)	76
$V_{GSS}$	Gate-Source voltage	$\pm 30$	V
$E_{AS}$	Single Pulsed Avalanche Energy (Note 2)	945	mJ
$I_{AR}$	Avalanche Current (Note 1)	19	A
$E_{AR}$	Repetitive Avalanche Energy (Note 1)	23	mJ
dv/dt	Peak Diode Recovery dv/dt (Note 3)	4.5	V/ns
$P_D$	Power Dissipation	( $T_C = 25^\circ\text{C}$ )	239
		- Derate above $25^\circ\text{C}$	1.92
$T_J, T_{STG}$	Operating and Storage Temperature Range	-55 to +150	$^\circ\text{C}$
$T_L$	Maximum Lead Temperature for Soldering Purpose, 1/8" from Case for 5 Seconds	300	$^\circ\text{C}$

#### Thermal Characteristics

Symbol	Parameter	FDA18N50	Unit
$R_{\theta JC}$	Thermal Resistance, Junction-to-Case, Max.	0.52	$^\circ\text{C/W}$
$R_{\theta JA}$	Thermal Resistance, Junction-to-Ambient, Max.	40	

## Package Marking and Ordering Information

Device Marking	Device	Package	Reel Size	Tape Width	Quantity
FDA18N50	FDA18N50	TO-3PN	-	-	30

## Electrical Characteristics T<sub>C</sub> = 25°C unless otherwise noted

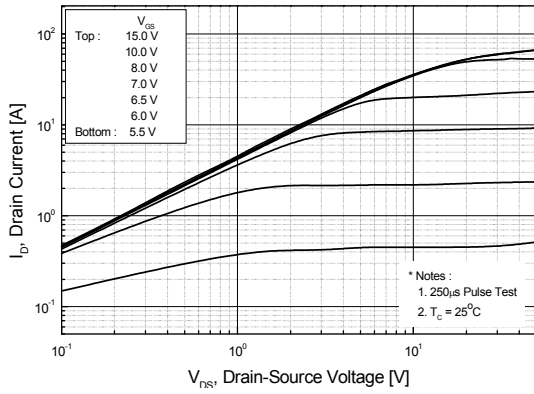
Symbol	Parameter	Conditions	Min.	Typ.	Max	Unit
<b>Off Characteristics</b>						
BV <sub>DSS</sub>	Drain-Source Breakdown Voltage	V <sub>GS</sub> = 0V, I <sub>D</sub> = 250μA	500	--	--	V
ΔBV <sub>DSS</sub> / ΔT <sub>J</sub>	Breakdown Voltage Temperature Coefficient	I <sub>D</sub> = 250μA, Referenced to 25°C	--	0.5	--	V/°C
I <sub>DSS</sub>	Zero Gate Voltage Drain Current	V <sub>DS</sub> = 500V, V <sub>GS</sub> = 0V V <sub>DS</sub> = 400V, T <sub>C</sub> = 125°C	--	--	1 10	μA μA
I <sub>GSSF</sub>	Gate-Body Leakage Current, Forward	V <sub>GS</sub> = 30V, V <sub>DS</sub> = 0V	--	--	100	nA
I <sub>GSSR</sub>	Gate-Body Leakage Current, Reverse	V <sub>GS</sub> = -30V, V <sub>DS</sub> = 0V	--	--	-100	nA
<b>On Characteristics</b>						
V <sub>GS(th)</sub>	Gate Threshold Voltage	V <sub>DS</sub> = V <sub>GS</sub> , I <sub>D</sub> = 250μA	3.0	--	5.0	V
R <sub>DS(on)</sub>	Static Drain-Source On-Resistance	V <sub>GS</sub> = 10V, I <sub>D</sub> = 9.5A	--	0.220	0.265	Ω
g <sub>FS</sub>	Forward Transconductance	V <sub>DS</sub> = 40V, I <sub>D</sub> = 9.5A	--	25	--	S
<b>Dynamic Characteristics</b>						
C <sub>iss</sub>	Input Capacitance	V <sub>DS</sub> = 25V, V <sub>GS</sub> = 0V, f = 1.0MHz	--	2200	2860	pF
C <sub>oss</sub>	Output Capacitance		--	330	430	pF
C <sub>rss</sub>	Reverse Transfer Capacitance		--	25	40	pF
<b>Switching Characteristics</b>						
t <sub>d(on)</sub>	Turn-On Delay Time	V <sub>DD</sub> = 250V, I <sub>D</sub> = 19A R <sub>G</sub> = 25Ω	--	55	120	ns
t <sub>r</sub>	Turn-On Rise Time		--	165	340	ns
t <sub>d(off)</sub>	Turn-Off Delay Time		--	95	200	ns
t <sub>f</sub>	Turn-Off Fall Time		(Note 4)	--	90	190
Q <sub>g</sub>	Total Gate Charge	V <sub>DS</sub> = 400V, I <sub>D</sub> = 19A V <sub>GS</sub> = 10V	--	45	60	nC
Q <sub>gs</sub>	Gate-Source Charge		--	12.5	--	nC
Q <sub>gd</sub>	Gate-Drain Charge		(Note 4)	--	19	--
<b>Drain-Source Diode Characteristics and Maximum Ratings</b>						
I <sub>S</sub>	Maximum Continuous Drain-Source Diode Forward Current		--	--	19	A
I <sub>SM</sub>	Maximum Pulsed Drain-Source Diode Forward Current		--	--	76	A
V <sub>SD</sub>	Drain-Source Diode Forward Voltage	V <sub>GS</sub> = 0V, I <sub>S</sub> = 19A	--	--	1.4	V
t <sub>rr</sub>	Reverse Recovery Time	V <sub>GS</sub> = 0V, I <sub>S</sub> = 19A di <sub>F</sub> /dt = 100A/μs	--	500	--	ns
Q <sub>rr</sub>	Reverse Recovery Charge		--	5.4	--	μC

### NOTES:

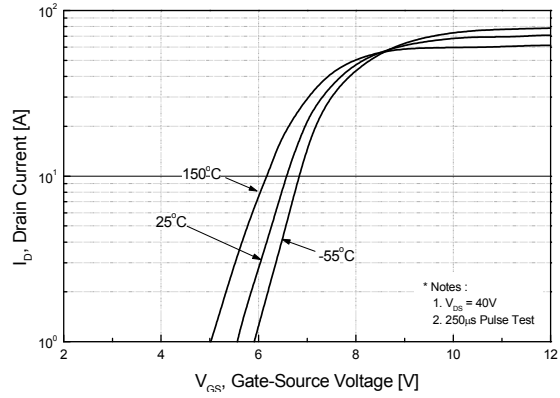
1. Repetitive Rating: Pulse width limited by maximum junction temperature
2. L = 4.7mH, I<sub>AS</sub> = 19A, V<sub>DD</sub> = 50V, R<sub>G</sub> = 25Ω, Starting T<sub>J</sub> = 25°C
3. I<sub>SD</sub> ≤ 19A, di/dt ≤ 200A/μs, V<sub>DD</sub> ≤ BV<sub>DSS</sub>, Starting T<sub>J</sub> = 25°C
4. Essentially Independent of Operating Temperature Typical Characteristics

## Typical Performance Characteristics

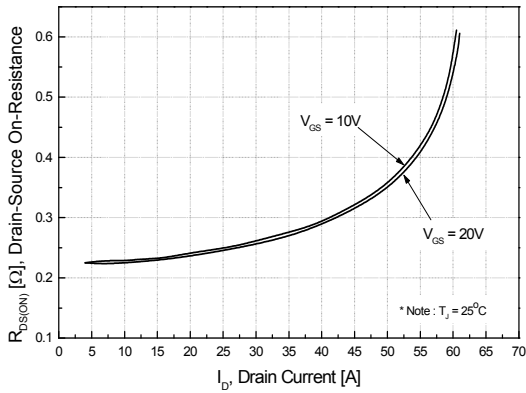
**Figure 1. On-Region Characteristics**



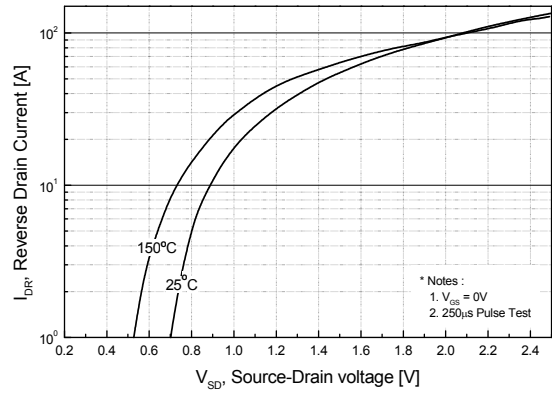
**Figure 2. Transfer Characteristics**



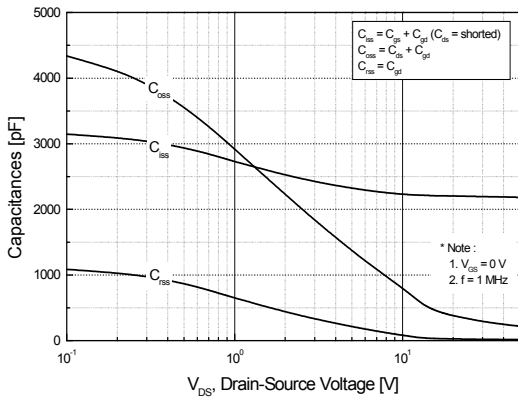
**Figure 3. On-Resistance Variation vs. Drain Current and Gate Voltage**



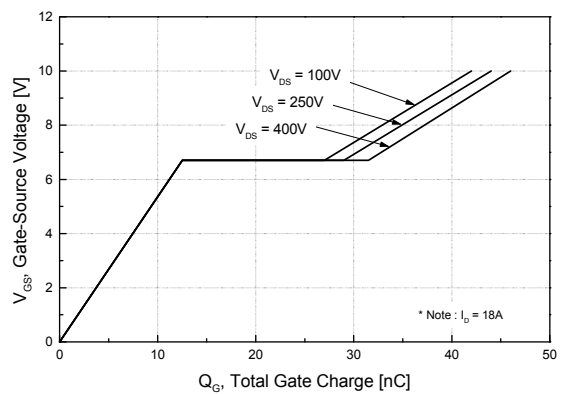
**Figure 4. Body Diode Forward Voltage Variation vs. Source Current and Temperature**



**Figure 5. Capacitance Characteristics**

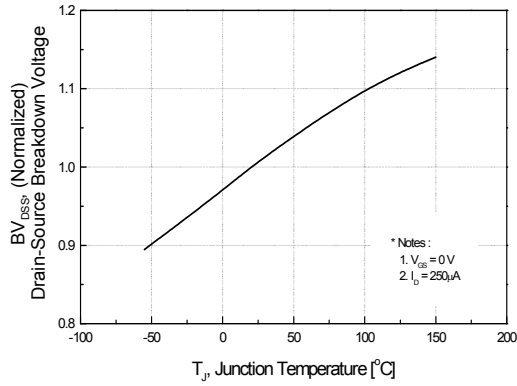


**Figure 6. Gate Charge Characteristics**

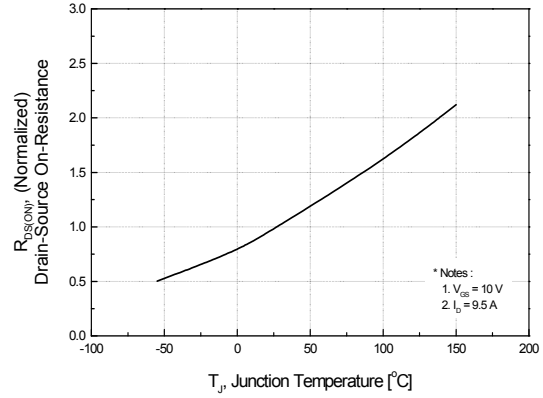


**Typical Performance Characteristics** (Continued)

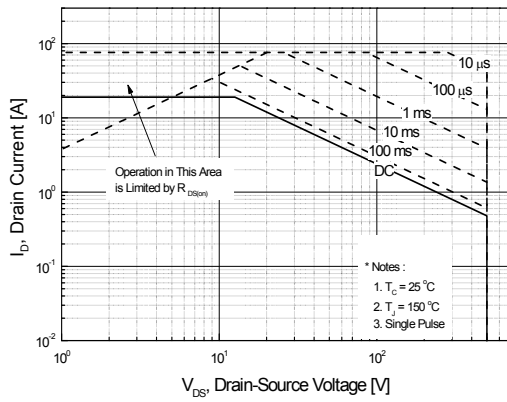
**Figure 7. Breakdown Voltage Variation vs. Temperature**



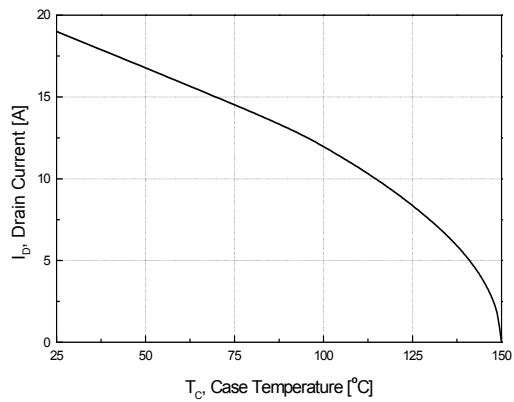
**Figure 8. On-Resistance Variation vs. Temperature**



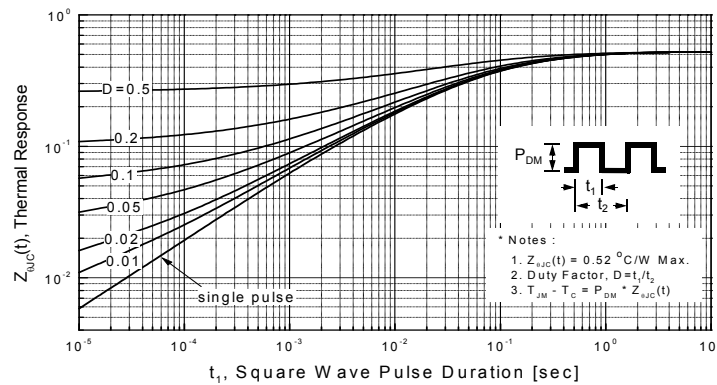
**Figure 9. Maximum Safe Operating Area**



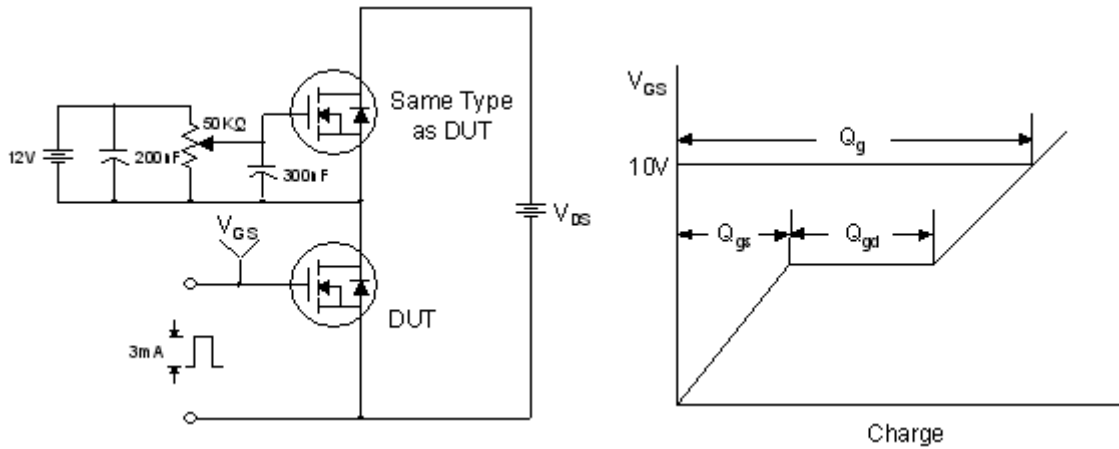
**Figure 10. Maximum Drain Current vs. Case Temperature**



**Figure 11. Transient Thermal Response Curve**



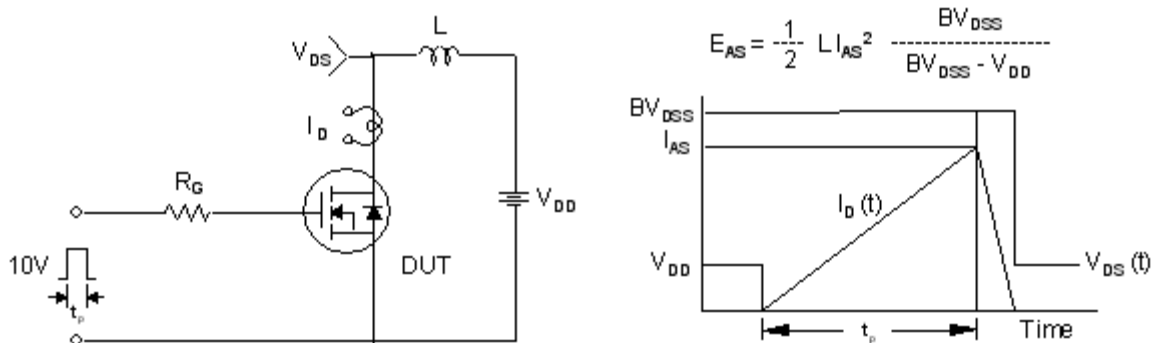
**Gate Charge Test Circuit & Waveform**



**Resistive Switching Test Circuit & Waveforms**



**Unclamped Inductive Switching Test Circuit & Waveforms**

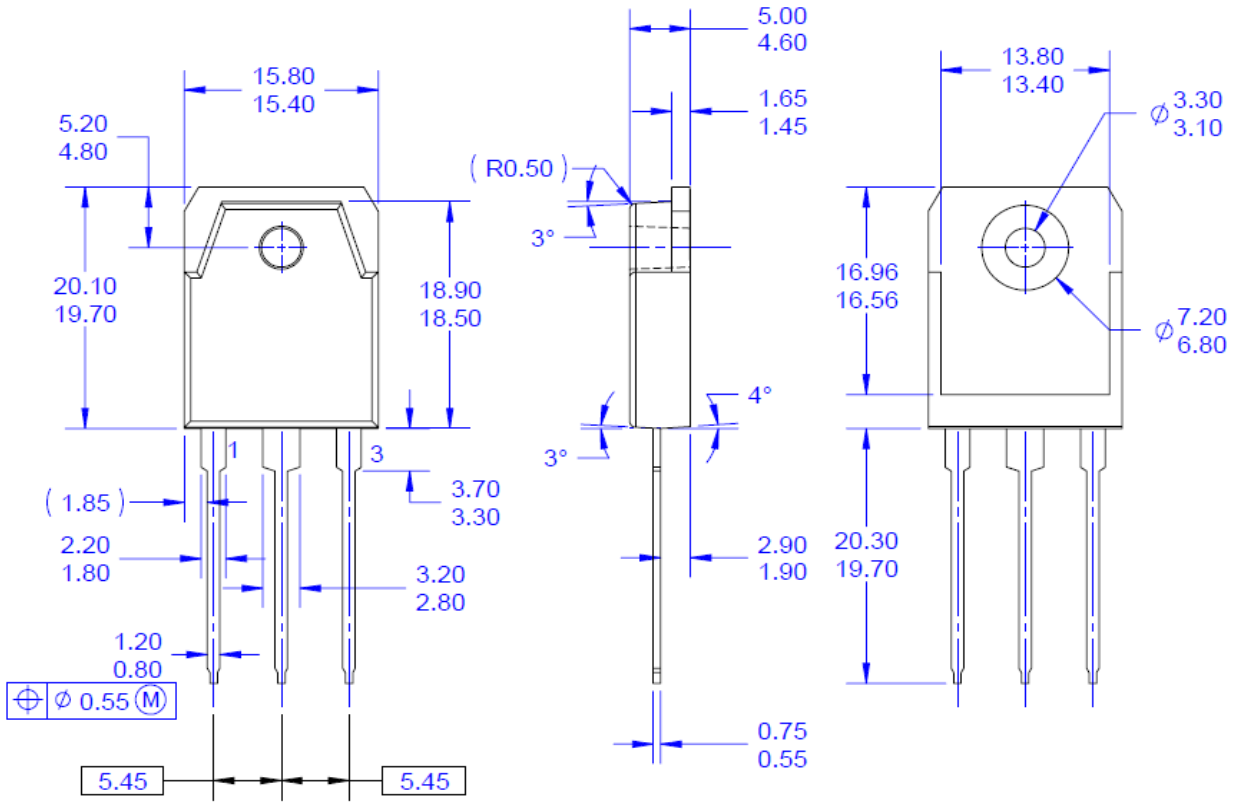


**Peak Diode Recovery dv/dt Test Circuit & Waveforms**



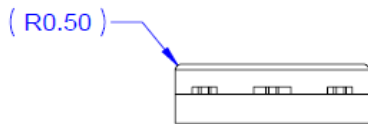
**Mechanical Dimensions**

**TO-3PN**



**NOTES: UNLESS OTHERWISE SPECIFIED**

- A) THIS PACKAGE CONFORMS TO EIAJ SC-65 PACKAGING STANDARD.
- B) ALL DIMENSIONS ARE IN MILLIMETERS.
- C) DIMENSION AND TOLERANCING PER ASME14.5
- D) DIMENSIONS ARE EXCLUSIVE OF BURRS, MOLD FLASH, AND TIE BAR EXTRUSIONS.
- E) THIS PACKAGE IS INTENDED ONLY FOR TO3PN.
- F) DRAWING FILE NAME: TO3P03AREV4.



Dimensions in Millimeters



**TRADEMARKS**

The following includes registered and unregistered trademarks and service marks, owned by Fairchild Semiconductor and/or its global subsidiaries, and is not intended to be an exhaustive list of all such trademarks.

- |                          |   |                                       |                          |
|--------------------------|---|---------------------------------------|--------------------------|
| 2Cool™                   | FPS™  | PowerTrench®                          | Sync-Lock™               |
| AccuPower™               | F-PFS™  | PowerXS™                              | <b>SYSTEM GENERAL</b> ®* |
| AX-CAP®*                 | FRFET®  | Programmable Active Droop™            | TinyBoost™               |
| BitSiC™                  | Global Power Resource <sup>SM</sup>             | QFET®                                 | TinyBuck™                |
| Build it Now™            | Green Bridge™                                   | QS™                                   | TinyCalc™                |
| CorePLUS™                | Green FPS™                                      | Quiet Series™                         | TinyLogic®               |
| CorePOWER™               | Green FPS™ e-Series™                            | RapidConfigure™                       | TINYOPTO™                |
| CROSSVOLT™               | Gmax™   | TM                                    | TinyPower™               |
| CTL™                     | GTO™  | Saving our world, 1mW/W/kW at a time™ | TinyPWM™                 |
| Current Transfer Logic™  | IntelliMAX™                                     | SignalWise™                           | TinyWire™                |
| DEUXPEED®                | ISOPLANAR™                                      | SmartMax™                             | TranSiC®                 |
| Dual Cool™               | Marking Small Speakers Sound Louder and Better™ | SMART START™                          | TriFault Detect™         |
| EcoSPARK®                | MegaBuck™                                       | Solutions for Your Success™           | TRUECURRENT®*            |
| EfficientMax™            | MICROCOUPLER™                                   | SPM®                                  | µSerDes™                 |
| ESBC™                    | MicroFET™                                       | STEALTH™                              | <b>µSerDes™</b>          |
| <b>F</b> ®               | MicroPak™                                       | SuperFET®                             | UHC®                     |
| Fairchild®               | MicroPak2™                                      | SuperSOT™-3                           | Ultra FRFET™             |
| Fairchild Semiconductor® | MillerDrive™                                    | SuperSOT™-6                           | UNIFET™                  |
| FACT Quiet Series™       | MotionMax™                                      | SuperSOT™-8                           | VCX™                     |
| FACT®                    | mWSaver™  | SupreMOS®                             | VisualMax™               |
| FAST®                    | OptoHit™  | SyncFET™                              | VoltagePlus™             |
| FastvCore™               | OPTOLOGIC®                                      |                                       | XS™                      |
| FETBench™                | OPTOPLANAR®                                     |                                       |                          |

\*Trademarks of System General Corporation, used under license by Fairchild Semiconductor.

**DISCLAIMER**

FAIRCHILD SEMICONDUCTOR RESERVES THE RIGHT TO MAKE CHANGES WITHOUT FURTHER NOTICE TO ANY PRODUCTS HEREIN TO IMPROVE RELIABILITY, FUNCTION, OR DESIGN. FAIRCHILD DOES NOT ASSUME ANY LIABILITY ARISING OUT OF THE APPLICATION OR USE OF ANY PRODUCT OR CIRCUIT DESCRIBED HEREIN; NEITHER DOES IT CONVEY ANY LICENSE UNDER ITS PATENT RIGHTS, NOR THE RIGHTS OF OTHERS. THESE SPECIFICATIONS DO NOT EXPAND THE TERMS OF FAIRCHILD'S WORLDWIDE TERMS AND CONDITIONS, SPECIFICALLY THE WARRANTY THEREIN, WHICH COVERS THESE PRODUCTS.

**LIFE SUPPORT POLICY**

FAIRCHILD'S PRODUCTS ARE NOT AUTHORIZED FOR USE AS CRITICAL COMPONENTS IN LIFE SUPPORT DEVICES OR SYSTEMS WITHOUT THE EXPRESS WRITTEN APPROVAL OF FAIRCHILD SEMICONDUCTOR CORPORATION.

As used here in:

1. Life support devices or systems are devices or systems which, (a) are intended for surgical implant into the body or (b) support or sustain life, and (c) whose failure to perform when properly used in accordance with instructions for use provided in the labeling, can be reasonably expected to result in a significant injury of the user.
2. A critical component in any component of a life support, device, or system whose failure to perform can be reasonably expected to cause the failure of the life support device or system, or to affect its safety or effectiveness.

**ANTI-COUNTERFEITING POLICY**

Fairchild Semiconductor Corporation's Anti-Counterfeiting Policy. Fairchild's Anti-Counterfeiting Policy is also stated on our external website, [www.Fairchildsemi.com](http://www.Fairchildsemi.com), under Sales Support.

Counterfeiting of semiconductor parts is a growing problem in the industry. All manufactures of semiconductor products are experiencing counterfeiting of their parts. Customers who inadvertently purchase counterfeit parts experience many problems such as loss of brand reputation, substandard performance, failed application, and increased cost of production and manufacturing delays. Fairchild is taking strong measures to protect ourselves and our customers from the proliferation of counterfeit parts. Fairchild strongly encourages customers to purchase Fairchild parts either directly from Fairchild or from Authorized Fairchild Distributors who are listed by country on our web page cited above. Products customers buy either from Fairchild directly or from Authorized Fairchild Distributors are genuine parts, have full traceability, meet Fairchild's quality standards for handling and storage and provide access to Fairchild's full range of up-to-date technical and product information. Fairchild and our Authorized Distributors will stand behind all warranties and will appropriately address and warranty issues that may arise. Fairchild will not provide any warranty coverage or other assistance for parts bought from Unauthorized Sources. Fairchild is committed to combat this global problem and encourage our customers to do their part in stopping this practice by buying direct or from authorized distributors.

**PRODUCT STATUS DEFINITIONS**

**Definition of Terms**

Datasheet Identification	Product Status	Definition
Advance Information	Formative / In Design	Datasheet contains the design specifications for product development. Specifications may change in any manner without notice.
Preliminary	First Production	Datasheet contains preliminary data; supplementary data will be published at a later date. Fairchild Semiconductor reserves the right to make changes at any time without notice to improve design.
No Identification Needed	Full Production	Datasheet contains final specifications. Fairchild Semiconductor reserves the right to make changes at any time without notice to improve the design.
Obsolete	Not In Production	Datasheet contains specifications on a product that is discontinued by Fairchild Semiconductor. The datasheet is for reference information only.

Rev. 164