



Demonstration board user guidelines for the TS2012 filter-free stereo 2 x 2.8 W class D audio power amplifier

Introduction

This application note applies to the STEVAL-CCA007V1 demonstration board, designed to evaluate the stereo class D audio differential amplifier TS2012.

The document provides:

- a brief description of the TS2012 device,
- a description of the demonstration board and all of its components,
- the layout of the demonstration board.

About the TS2012

The TS2012 is a fully-differential class D stereo power amplifier that can drive up to 1.35 W into an 8 Ω load at 5 V per channel. It achieves outstanding efficiency compared to typical class AB audio amplifiers.

The device has four different gain settings that use two digital pins: G0 and G1. Pop and click reduction circuitry provides low on/off switch noise while allowing the device to start within 1 ms. Two standby pins (active low) allow each channel to be switched off independently.

The TS2012 is available in a 4 x 4 mm QFN20 package.

Key features of the TS2012

- Operating range from $V_{CC} = 2.5$ to 5.5 V
- Standby mode active low
- Output power per channel: 1.35 W at 5 V or 0.68 W at 3.6 V into 8 Ω with 1% THD+N max
- Output power per channel: 2.2 W at 5 V into 4 Ω with 1% THD+N max
- Four gain select settings: 6, 12, 18, 24 dB
- Low current consumption
- PSRR: 70 dB typ at 217 Hz with 6 dB gain
- Fast start-up phase: 1 ms
- Thermal shutdown protection
- QFN20 4 x 4 mm lead-free package









Refer to the datasheet for complete information on the TS2012.

1 Description of the demonstration board

The STEVAL-CCA007V1 is designed to evaluate the TS2012, a fully-differential class D stereo power amplifier. The TS2012 device, available in a QFN package, is mounted on a two-layer PCB with a copper area acting as a heatsink. Easily-accessible on-board connectors are used to change or drive the gain select pins (G0 and G1) and the standby control pins. The input configuration of the TS2012 can also be changed.

The differential **gain** of the TS2012 can be set to 6, 12, 18, or 24 dB, depending on the logic level of the G0 pin (connected to pin 2 of the P3) and G1 pin (connected to pin 2 of the P2).

Table 1. Gain settings with G0 and G1 pins

G1	G0	P2	P3	Gain (dB)	Gain (V/V)
0	0			6	2
0	1			12	4
1	0			18	8
1	1			24	16

Note: There is an internal 300 kΩ (+/-20%) resistor between pins G0, G1 and GND. When the pins are floating (P2 and P3 included), the gain is 6 dB. In full standby mode (left and right channels OFF), these resistors are disconnected (HiZ input).

The **input configuration** is either capacitor-coupled or common-mode feedback. On the board, the connectors for the left channel (P13 and P14) and those for the right channel (P23 and P24) allow you to change the input configuration.

In the **capacitor-coupled configuration**, the -3 dB cut-off frequency F_c in Hz is:





$$F_c = \frac{1}{2\pi \cdot Z_{in} \cdot C_{in}}$$

with Z_{in} in Ω ($Z_{in} = 30$ kΩ typically), C_{in} in Farads, $C_{13} = C_{14}$ and $C_{23} = C_{24}$.

Note: On the TS2012 demonstration board $C_{in} = C_{13} = C_{14} = C_{23} = C_{24} = 220$ nF, which means that $F_c = 24.1$ Hz for both channels.

More information on component calculations is available in the TS2012 datasheet.

Table 2. Demonstration board connectors

Connector(s)	Description
P1	Power connector (V_{CC} and GND). Power supply voltage from 2.5 to 5.5 V.
P2, P3	<p>Gain setting connectors - P2 for the G1 pin, P3 for the G0 pin of the TS2012. The connector pins are connected as follows:</p> <ul style="list-style-type: none"> – 1 to V_{CC} – 2 of P2 to the G1 pin – 2 of P3 to the G0 pin – 3 to GND <p>Jumper positions:</p> <ul style="list-style-type: none"> – logical "1": pins 1 and 2 are shorted  – logical "0": pins 2 and 3 are shorted 
P4, P5	<p>Standby control connector - P4 for the right channel, P5 for the left channel. The connector pins are connected as follows:</p> <ul style="list-style-type: none"> – 1 to V_{CC} – 2 of P4 to the STBYR pin of the TS2012 – 2 of P5 to the STBYL pin of the TS2012 – 3 to GND <p>Jumper positions:</p> <ul style="list-style-type: none"> –  when pins 1 and 2 are shorted, the channel is operating. –  when pins 2 and 3 are shorted or pin 2 is floating, the channel is in standby mode.
P11	Left channel positive input signal connectors (active input signal L_{in+} and GND)
P12	Left channel negative input signal connectors (active input signal L_{in-} and GND)
P21	Right channel positive input signal connectors (active input signal R_{in+} and GND)
P22	Right channel negative input signal connectors (active input signal R_{in-} and GND)
P13, P14, P23, P24	<p>Input configuration:</p> <ul style="list-style-type: none"> – capacitor coupled when P13 and P14 (P23 and P24) are disconnected. – common-mode feedback when P13 and P14 (P23 and P24) are shorted by jumpers.
P15	Left channel output signal connector (positive and negative output)
P25	Right channel output signal connector (positive and negative output)

Caution: When you apply the power supply through P1, **do not** invert the polarity as this will irreversibly damage the U1 amplifier.

Figure 1. Schematic diagram

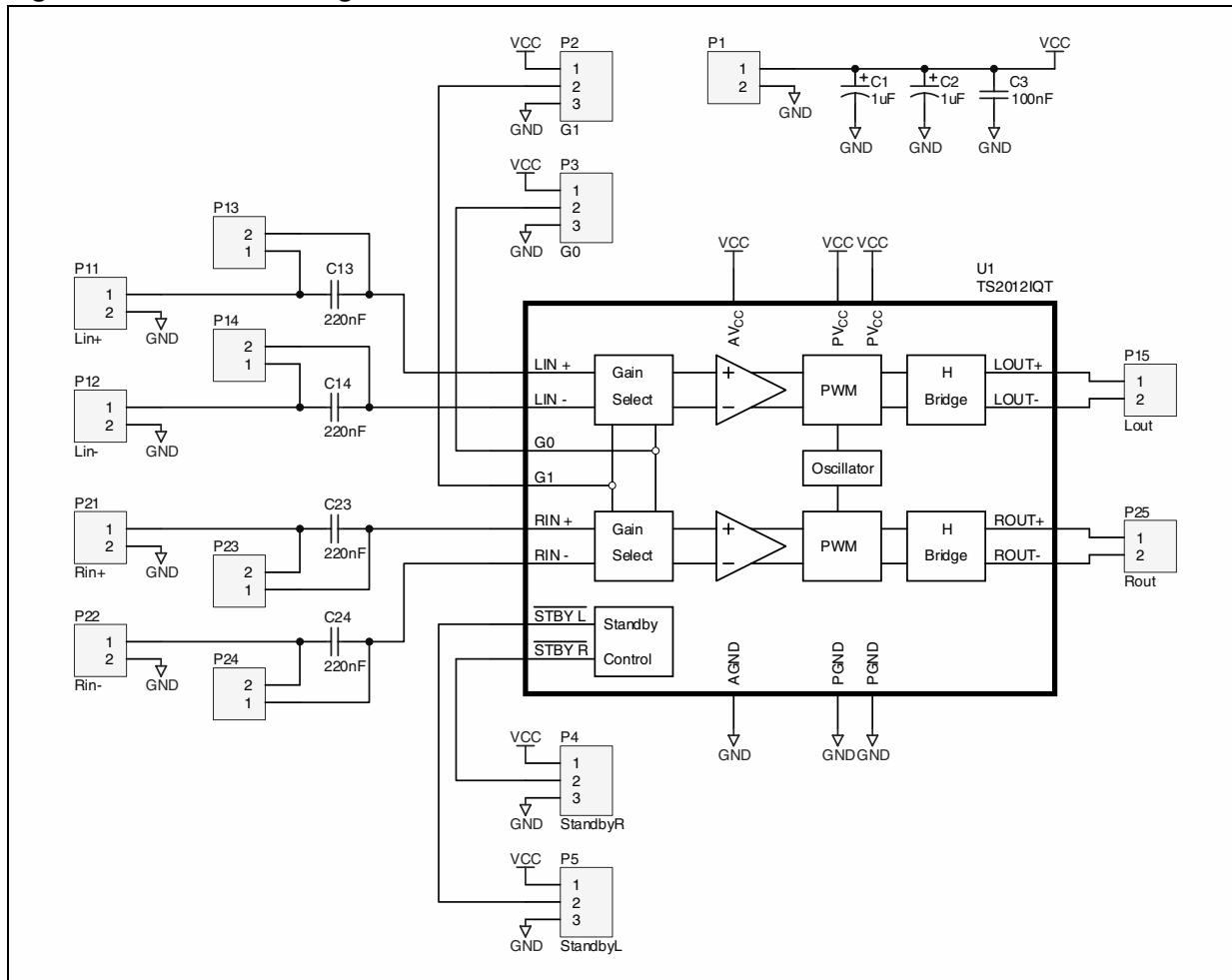

Table 3. Demonstration board component list

Designation	Quantity	Description
C1, C2, C3	3	1 µF/16 V, SMD ceramic capacitors, 0603
C12, C14, C23, C24	4	220 nF/16 V, SMD ceramic capacitor, 0603
P1, P11, P12, P13, P14, P15, P21, P22, P23, P24, P25	11	2-pin header, 2.54 mm pitch
P2, P3, P4, P5	4	3-pin header, 2.54 mm pitch
U1	1	TS2012IQT

2 Demonstration board layout

The following schematics show the layers and top view of the demonstration board.

Figure 2. PCB top layer

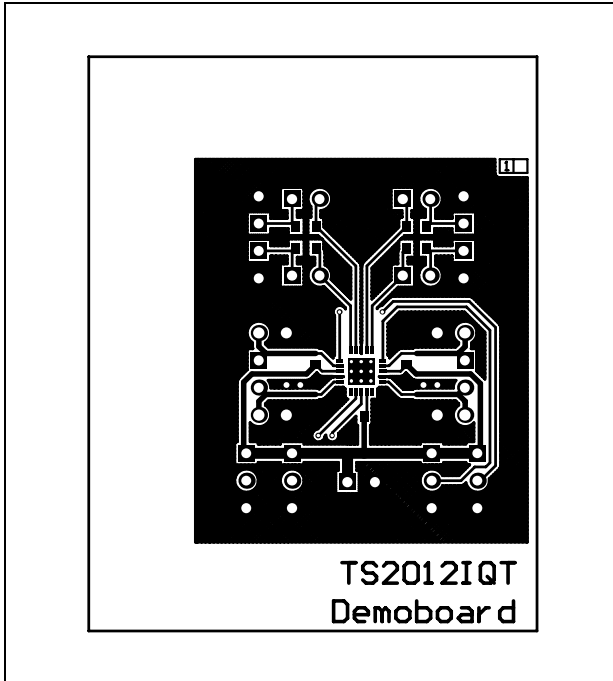

Figure 3. PCB bottom layer

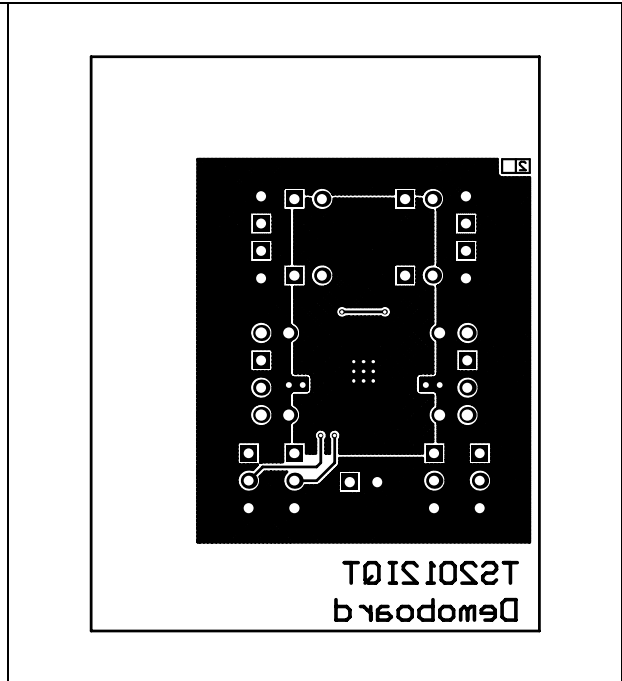
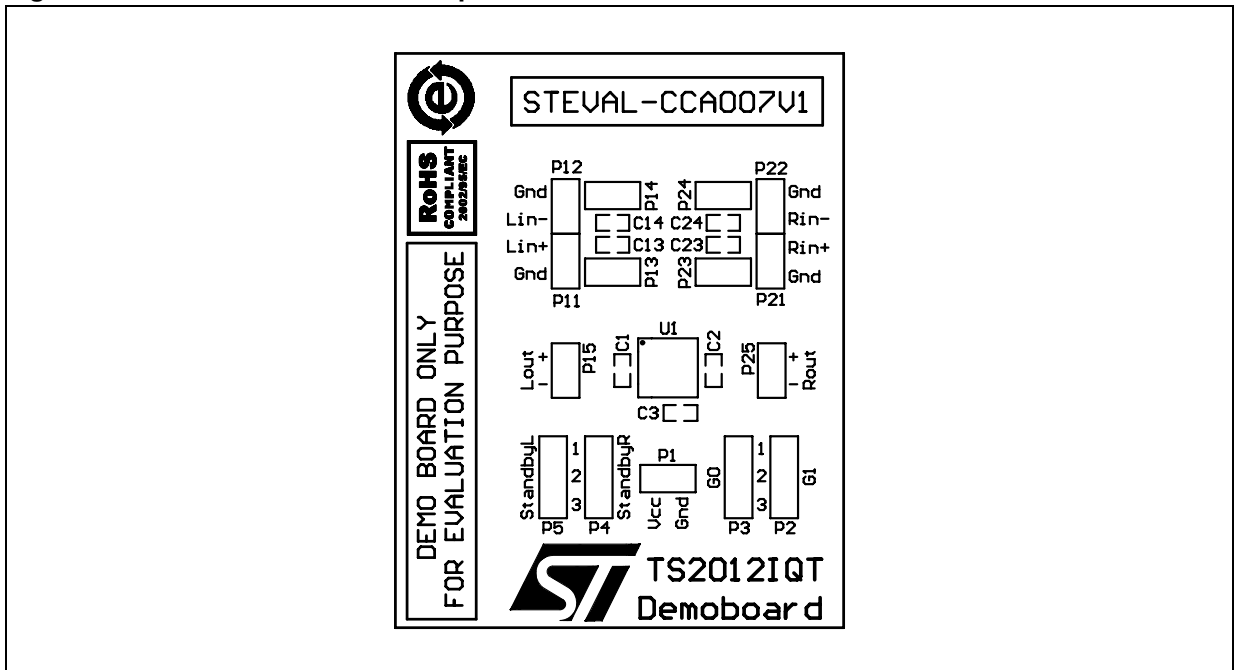

Figure 4. Demonstration board top view and dimensions



3 Conclusion

To order the board online, go to http://www.st.com/stonline/domains/buy/buy_dev.htm, and use the order code STEVAL-CCA007V1.

4 Revision history

Table 4. Document revision history

Date	Revision	Changes
28-Aug-2009	1	Initial release.

Please Read Carefully:

Information in this document is provided solely in connection with ST products. STMicroelectronics NV and its subsidiaries ("ST") reserve the right to make changes, corrections, modifications or improvements, to this document, and the products and services described herein at any time, without notice.

All ST products are sold pursuant to ST's terms and conditions of sale.

Purchasers are solely responsible for the choice, selection and use of the ST products and services described herein, and ST assumes no liability whatsoever relating to the choice, selection or use of the ST products and services described herein.

No license, express or implied, by estoppel or otherwise, to any intellectual property rights is granted under this document. If any part of this document refers to any third party products or services it shall not be deemed a license grant by ST for the use of such third party products or services, or any intellectual property contained therein or considered as a warranty covering the use in any manner whatsoever of such third party products or services or any intellectual property contained therein.

UNLESS OTHERWISE SET FORTH IN ST'S TERMS AND CONDITIONS OF SALE ST DISCLAIMS ANY EXPRESS OR IMPLIED WARRANTY WITH RESPECT TO THE USE AND/OR SALE OF ST PRODUCTS INCLUDING WITHOUT LIMITATION IMPLIED WARRANTIES OF MERCHANTABILITY, FITNESS FOR A PARTICULAR PURPOSE (AND THEIR EQUIVALENTS UNDER THE LAWS OF ANY JURISDICTION), OR INFRINGEMENT OF ANY PATENT, COPYRIGHT OR OTHER INTELLECTUAL PROPERTY RIGHT.

UNLESS EXPRESSLY APPROVED IN WRITING BY AN AUTHORIZED ST REPRESENTATIVE, ST PRODUCTS ARE NOT RECOMMENDED, AUTHORIZED OR WARRANTED FOR USE IN MILITARY, AIR CRAFT, SPACE, LIFE SAVING, OR LIFE SUSTAINING APPLICATIONS, NOR IN PRODUCTS OR SYSTEMS WHERE FAILURE OR MALFUNCTION MAY RESULT IN PERSONAL INJURY, DEATH, OR SEVERE PROPERTY OR ENVIRONMENTAL DAMAGE. ST PRODUCTS WHICH ARE NOT SPECIFIED AS "AUTOMOTIVE GRADE" MAY ONLY BE USED IN AUTOMOTIVE APPLICATIONS AT USER'S OWN RISK.

Resale of ST products with provisions different from the statements and/or technical features set forth in this document shall immediately void any warranty granted by ST for the ST product or service described herein and shall not create or extend in any manner whatsoever, any liability of ST.

ST and the ST logo are trademarks or registered trademarks of ST in various countries.

Information in this document supersedes and replaces all information previously supplied.

The ST logo is a registered trademark of STMicroelectronics. All other names are the property of their respective owners.

© 2009 STMicroelectronics - All rights reserved

STMicroelectronics group of companies

Australia - Belgium - Brazil - Canada - China - Czech Republic - Finland - France - Germany - Hong Kong - India - Israel - Italy - Japan - Malaysia - Malta - Morocco - Philippines - Singapore - Spain - Sweden - Switzerland - United Kingdom - United States of America

www.st.com