

Silicon Fast Recovery Diode

$V_{RRM} = 800\text{ V} - 1000\text{ V}$

$I_F = 20\text{ A}$

Features

- High Surge Capability
- Types from 800 V to 1000 V V_{RRM}
- Not ESD Sensitive

Note:

1. Standard polarity: Stud is cathode.
2. Reverse polarity (R): Stud is anode.
3. Stud is base.

DO-5 Package

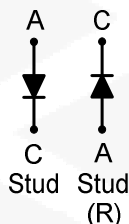

Maximum ratings, at $T_j = 25\text{ }^\circ\text{C}$, unless otherwise specified ("R" devices have leads reversed)

Parameter	Symbol	Conditions	FR20K(R)05	FR20M(R)05	Unit
Repetitive peak reverse voltage	V_{RRM}		800	1000	V
RMS reverse voltage	V_{RMS}		560	700	V
DC blocking voltage	V_{DC}		800	1000	V
Continuous forward current	I_F	$T_C \leq 100\text{ }^\circ\text{C}$	20	20	A
Surge non-repetitive forward current, Half Sine Wave	$I_{F,SM}$	$T_C = 25\text{ }^\circ\text{C}$, $t_p = 8.3\text{ ms}$	250	250	A
Operating temperature	T_j		-55 to 150	-55 to 150	$^\circ\text{C}$
Storage temperature	T_{stg}		-55 to 150	-55 to 150	$^\circ\text{C}$

Electrical characteristics, at $T_j = 25\text{ }^\circ\text{C}$, unless otherwise specified

Parameter	Symbol	Conditions	FR20K(R)05	FR20M(R)05	Unit
Diode forward voltage	V_F	$I_F = 20\text{ A}$, $T_j = 25\text{ }^\circ\text{C}$	1.0	1.0	V
Reverse current	I_R	$V_R = 800\text{ V}$, $T_j = 25\text{ }^\circ\text{C}$	25	25	μA
		$V_R = 800\text{ V}$, $T_j = 125\text{ }^\circ\text{C}$	10	10	mA

Recovery Time

Parameter	Symbol	Conditions	FR20K(R)05	FR20M(R)05	Unit
Maximum reverse recovery time	T_{RR}	$I_F = 0.5\text{ A}$, $I_R = 1.0\text{ A}$, $I_{RR} = 0.25\text{ A}$	500	500	nS

Thermal characteristics

Parameter	Symbol	FR20K(R)05	FR20M(R)05	Unit
Thermal resistance, junction - case	R_{thJC}	0.6	0.6	$^\circ\text{C/W}$

Figure .1-Typical Forward Characteristics

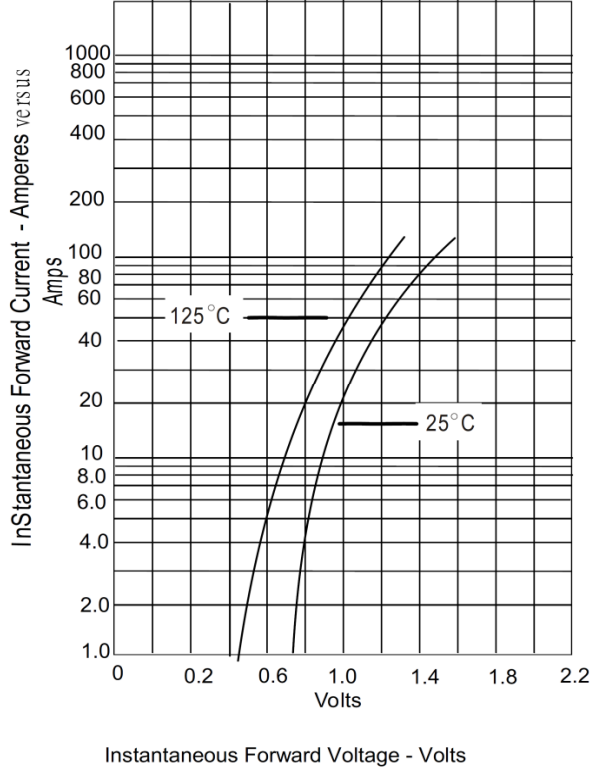
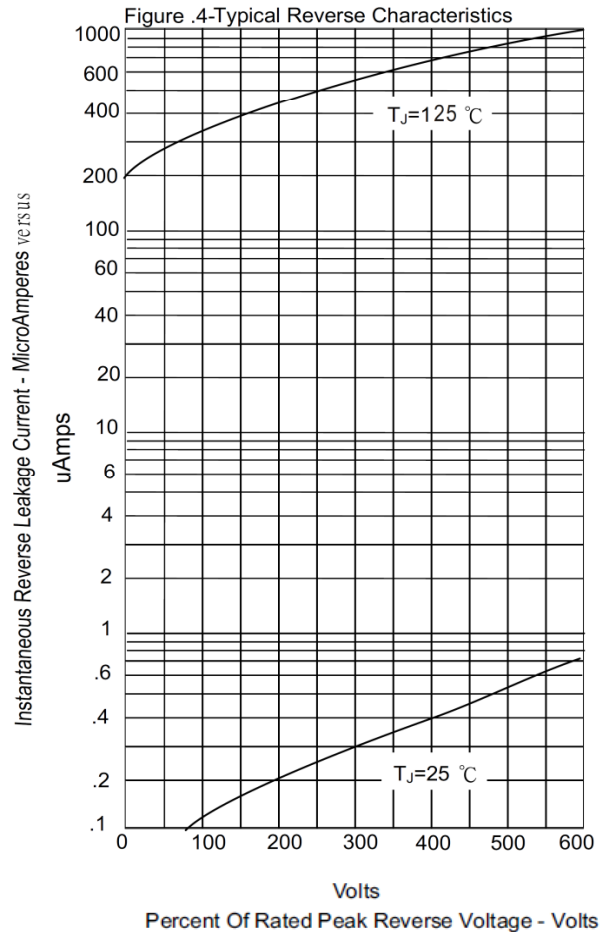
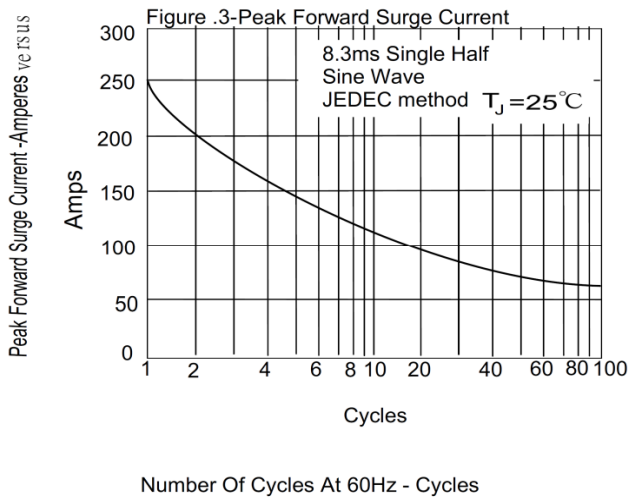
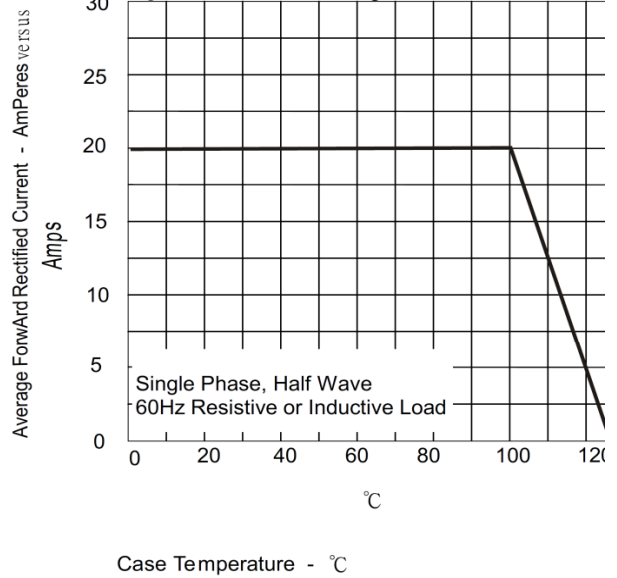
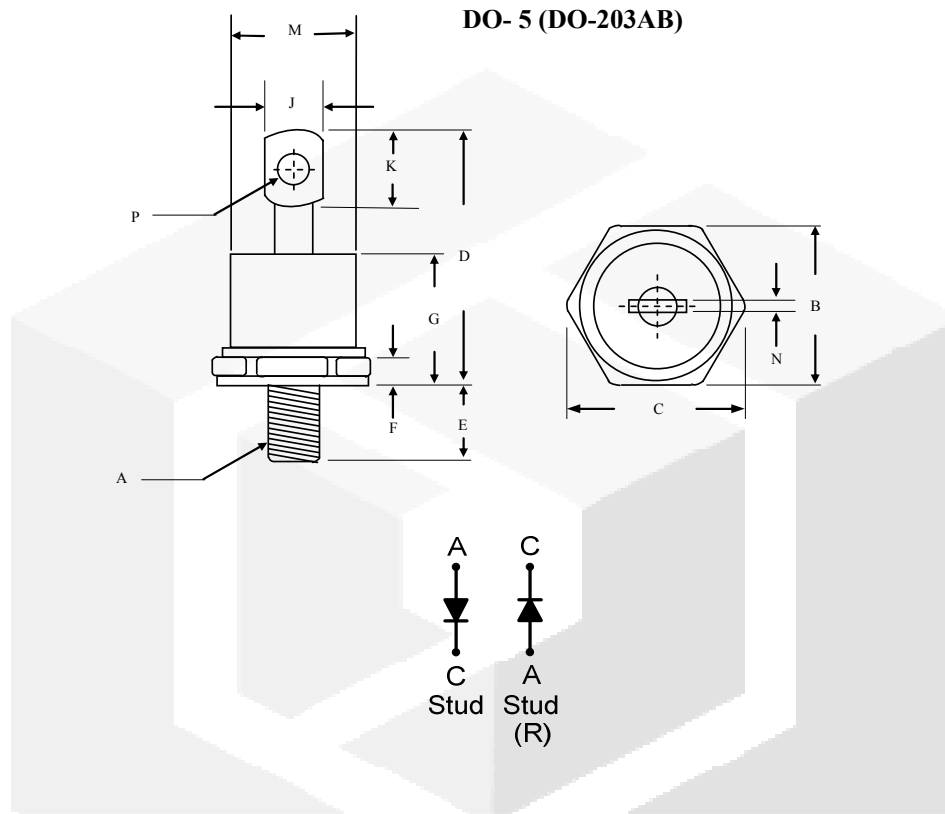

Figure .2-Forward Derating Curve



Package dimensions and terminal configuration

Product is marked with part number and terminal configuration.



	Inches		Millimeters	
	Min	Max	Min	Max
A	1/4 -28 UNF			
B	0.669	0.687	17.19	17.44
C	-----	0.794	-----	20.16
D	-----	1.020	-----	25.91
E	0.422	0.453	10.72	11.50
F	0.115	0.200	2.93	5.08
G	-----	0.460	-----	11.68
J	-----	0.280	-----	7.00
K	0.236	-----	6.00	-----
M	-----	0.589	-----	14.96
N	-----	0.063	-----	1.60
P	0.140	0.175	3.56	4.45