

FVP12030IM3LEG1

Energy Recovery

Feature

- Use of high speed 300V IGBTs with parallel FRDs
- Single-grounded power supply by means of built-in HVIC
- Sufficient current driving capability for IGBTs due to adding a buffer
- Isolation rating of 1500Vrms/min.
- Low leakage current due to using an insulated metal substrates

Applications

- Energy Recovery Part of a PDP (Plasma Display Panel)

General Description

It is an advanced smart power module (SPM™) that Fairchild has newly developed and designed to provide very compact and optimized performance for the energy recovery circuit of PDP driving system. It combines optimized circuit protection and drive matched to low-loss and high speed IGBTs. Under voltage lock-out protection function enhances the system reliability. The high speed built-in HVIC provides opto-couplerless single power supply IGBT gate driving capability that further reduce the overall system size of PDP sustaining boards.

Package Outlines



Figure 1.

Pin Configurations

Top View

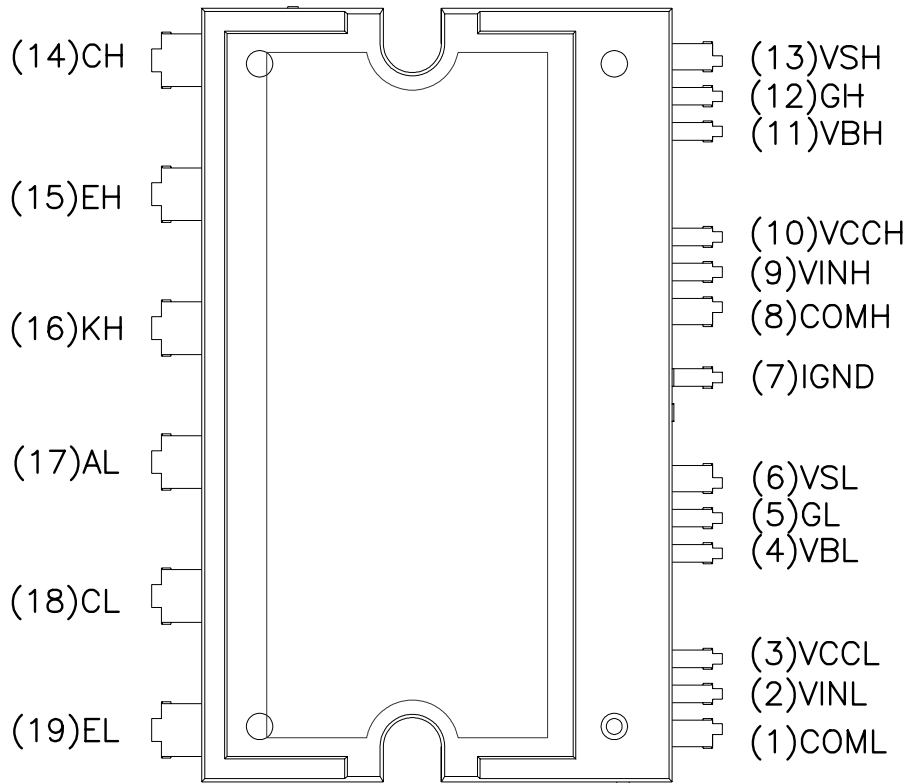

Figure 2.

Pin Descriptions

Pin Number	Pin Name	Pin Descriptions
1	COML	Low-side Signal Ground
2	VINL	Low-side Signal Input
3	VCCL	Low-side Supply Voltage for HVIC
4	VBL	Low-side Floating Supply Voltage for Buffer IC and IGBT Driving
5	GL	Low-side Gate
6	VSL	Low-side Floating Ground for Buffer IC and IGBT Driving
7	IGND	IMS Ground
8	COMH	High-side Signal Ground
9	VINH	High-side Signal Input
10	VCCH	High-side Supply Voltage for HVICg
11	VBH	High-side Floating Supply Voltage for Buffer IC and IGBT Driving
12	GH	High-side Gate
13	VSH	High-side Floating Ground for Buffer IC and IGBT Driving
14	CH	High-side IGBT Collector
15	EH	High-side IGBT Emitter
16	KH	High-side Diode Cathode
17	AL	Low-side Diode Anode
18	CL	Low-side IGBT Collector
19	EL	Low-side IGBT Emitter

Internal Equivalent Circuit and Input/Output Pins (Bottom View)

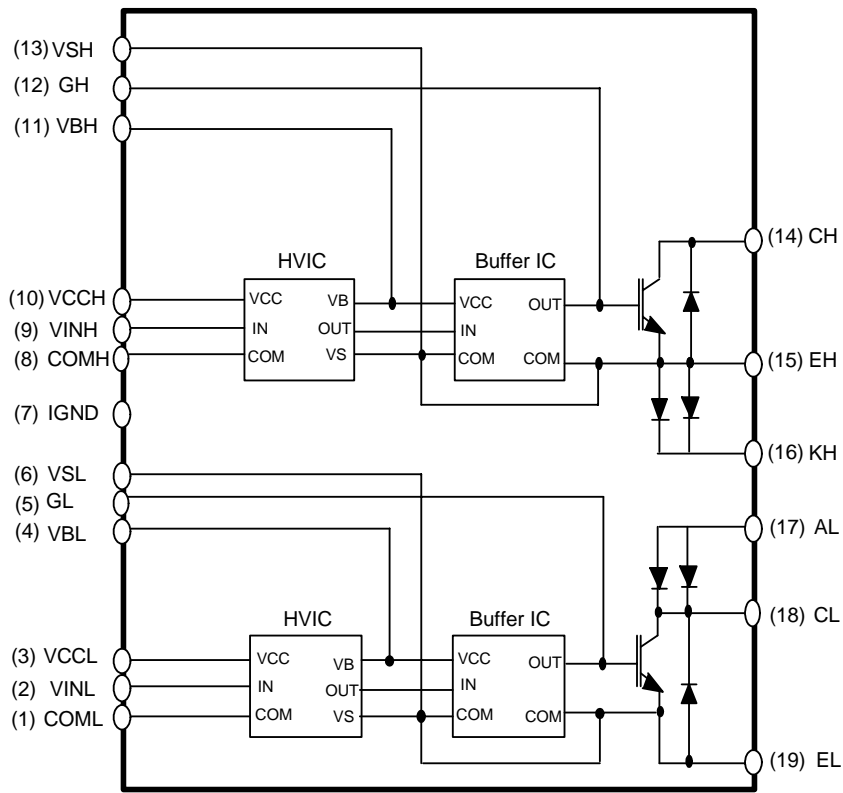

Figure 3.

Absolute Maximum Ratings ($T_C = 25^\circ\text{C}$, Unless Otherwise Specified)

Symbol	Parameter	Conditions	Rating	Units
VCC	Control Supply Voltage	Applied between VCCL-COML, VCCH - COMH	20	V
VBS	Control Bias Voltage	Applied between VBL - VSL, VBH - VSH	20	V
VIN	Input Signal Voltage	Applied between VINL-COML, VINH - COMH	-0.3~17	V

Symbol	Parameter	Conditions	Rating	Units
VCE	Collector to Emitter Voltage	Between CL to EL, Between CH to EH $V_{GH-EH}=V_{GL-EL}=0V$, $I_{CH}=I_{CL}=250\mu\text{A}$	300	V
VRRM	Peak Repetitive Reverse Voltage	Between KH to EH, Between CL to AL $I_{AH}=I_{AL}=250\mu\text{A}$	300	V
		Between CH to EH, Between CL to EL $I_{AH}=I_{AL}=250\mu\text{A}$	300	V
VIN	Input Signal Voltage	VINL, VINH	-0.3 to VCC+0.3	V
I_C	Collector Current Continuous	Between CL to EL, Between CH to EH	120	A
$I_{F(AV)}$	Average Rectified Forward Current	Between EH to KH, Between AL to CL per diode	30	A
		Between EH to CH, Between EL to CL	10	A
I_{CP}	Pulsed Collector Current	Between CL to EL, Between CH to EH (Note1)	300	A
I_{FP}	Pulsed Diode Current	Between EH to KH, Between AL to CL (Note1)	300	A
		Between EH to CH, Between EL to CL per diode (Note1)	100	A

Notes :1. Pulse Width = 100 μsec , Duty = 0.1; half sine wave* I_{CP} limited by MAX T_J

Symbol	Parameter	Conditions	Rating	Units
P_d	IGBT Dissipation	$T_C=25^\circ\text{C}$ per IGBT	117	W
		$T_C=100^\circ\text{C}$ per IGBT	47	W
	FRD Dissipation	$T_C=25^\circ\text{C}$ per diode	109	W
		$T_C=100^\circ\text{C}$ per diode	43	W
T_J	Operating Junction Temperature		-20 ~ 150	$^\circ\text{C}$
T_C	Module Case Operation Temperature		-20 ~ 125	$^\circ\text{C}$
T_{STG}	Storage Temperature		-40 ~ 125	$^\circ\text{C}$
V_{ISO}	Isolation Voltage	60Hz, Sinusoidal, AC 1 minute, Connection Pins to IMS substrate	1500	V_{rms}

Thermal Resistance

Symbol	Parameter	Conditions	Min.	Max.	Units
$R_{th(j-c)}$	Junction to Case Thermal Resistance	Between CH to EH, Between CL to EL Per IGBT	-	1.07	$^\circ\text{C/W}$
		Between EH to KH, Between AL to CL	-	1.15	$^\circ\text{C/W}$
		Between CH to EH, Between CL to EL Per Diode	-	3.70	$^\circ\text{C/W}$

Electrical Characteristics ($T_C = 25^\circ\text{C}$, Unless Otherwise Specified)

Symbol	Parameter	Conditions		Min.	Typ.	Max.	Units
I_{QCC}	Quiescent VCC Supply Current	VCC = 15V VINL, VINH = 0V	VCCL-COML, VCCH-COMH	-	-	100	μA
I_{QBS}	Quiescent VBS Supply Current	VBS = 15V VINL, VINH = 0V	VBL- VSL, VBH- VSH	-	-	500	μA
UV_{BSD}	Supply Circuit Under Voltage Protection	Detection Level		10.1	11.3	12.5	V
UV_{BSR}		Reset Level		10.5	11.7	12.9	V
$V_{IN(ON)}$	ON Threshold Voltage	Applied between VINL-COML, VINH - COMH		3.0	-	-	V
$V_{IN(OFF)}$	OFF Threshold Voltage			-	-	0.8	V

Symbol	Parameter	Condition		Min.	Typ.	Max.	Units
$V_{CE(SAT)}$	IGBT Collector-Emitter Saturation Voltage	VCC = VBS = 15V VIN = 5V	$I_C = 25\text{A}, T_J = 25^\circ\text{C}$	-	-	1.4	V
			$I_C = 120\text{A}, T_J = 25^\circ\text{C}$	-	1.9	-	V
V_F	Diode Forward Voltage	Between CL to AL Between KH to EH	$I_F = 30\text{A}, T_J = 25^\circ\text{C}$	-	-	1.4	V
			Between EH to CH Between EL to CL	$I_F = 10\text{A}, T_J = 25^\circ\text{C}$	-	-	1.7
t_{dON}	Switching Times	VCE=200V, VCC= VBS=15V $I_C = 20\text{A}$ VIN = 0V 5V, Inductive Load $T_C = 25^\circ\text{C}$ (Note2)			230		ns
t_r					55		ns
t_{dOFF}					270		ns
t_f					48		ns
I_{CES}	IGBT Collector-Emitter Leakage Current	$V_{CE} = 300\text{V}$		-	-	250	μA
I_R	Diode Anode-Cathode Leakage Current	Between CL to AL Between KH to EH	$V_{\text{Anode-Cathode}}=300\text{V}$			250	μA
		Between EH to CH Between EL to CL	$V_{\text{Anode-Cathode}}=300\text{V}$	-	-	250	μA

Notes :

2. t_{ON} and t_{OFF} include the propagation delay time of internal drive IC. For the detailed information, please see Figure 4.

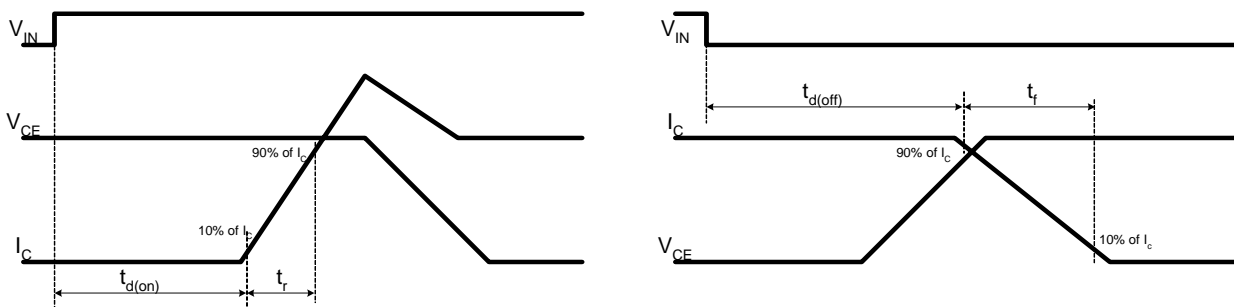

Figure 4. Switching Time Definition

Typical Performance Characteristics

Figure 5. Typical Output Characteristics

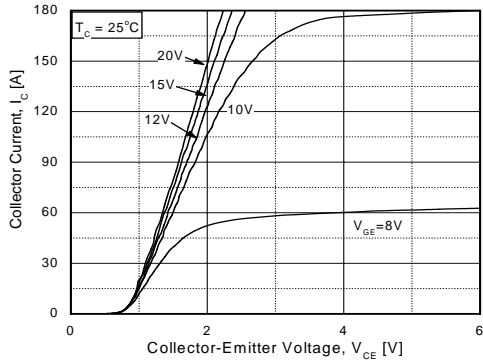

Figure 6. Typical Output Characteristics

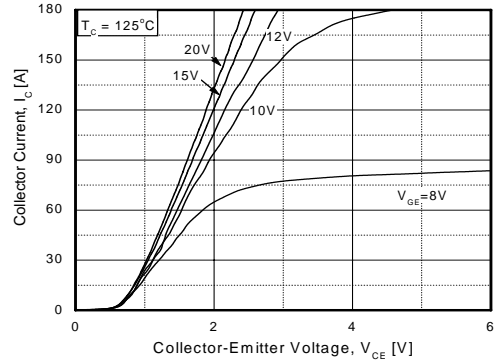

Figure 7. Typical Forward Voltage Drop

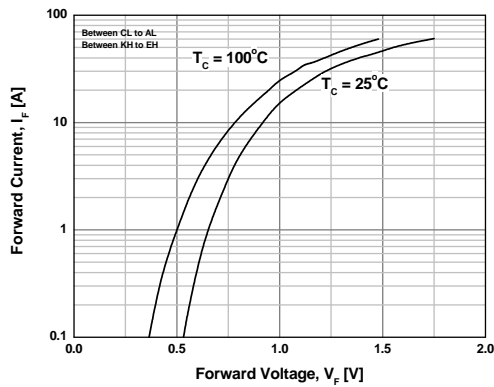

Figure 8. Typical Forward Voltage Drop

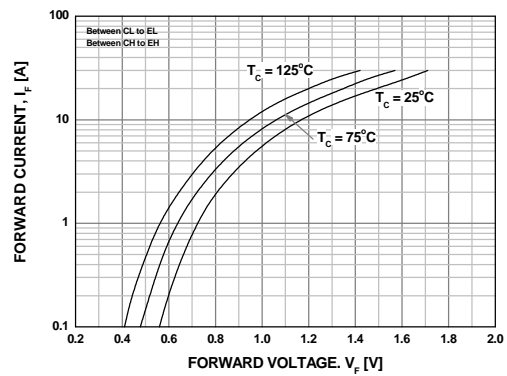
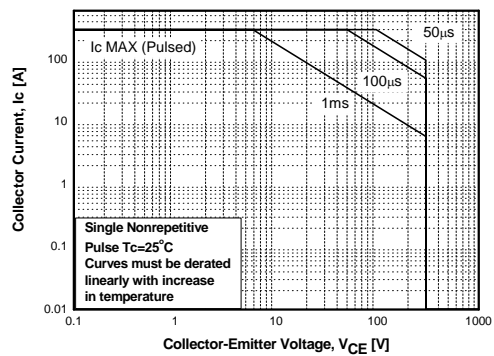

Figure 9. FBSOA



Mechanical Characteristics and Ratings

Parameter	Conditions		Limits			Units
			Min.	Typ.	Max.	
Mounting Torque	Mounting Screw: - M3	Recommended 0.62N•m	0.51	0.62	0.72	N•m
Device Flatness		Note Figure 5	0	-	+100	μm
Weight			-	13.4	-	g

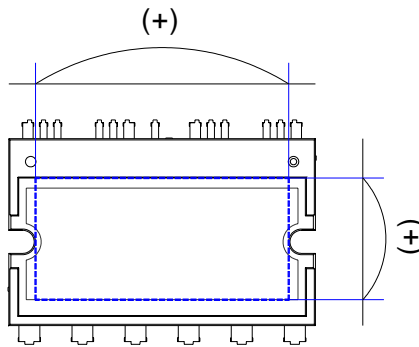

Figure 10. Flatness Measurement Position

Detailed Package Outline Drawings

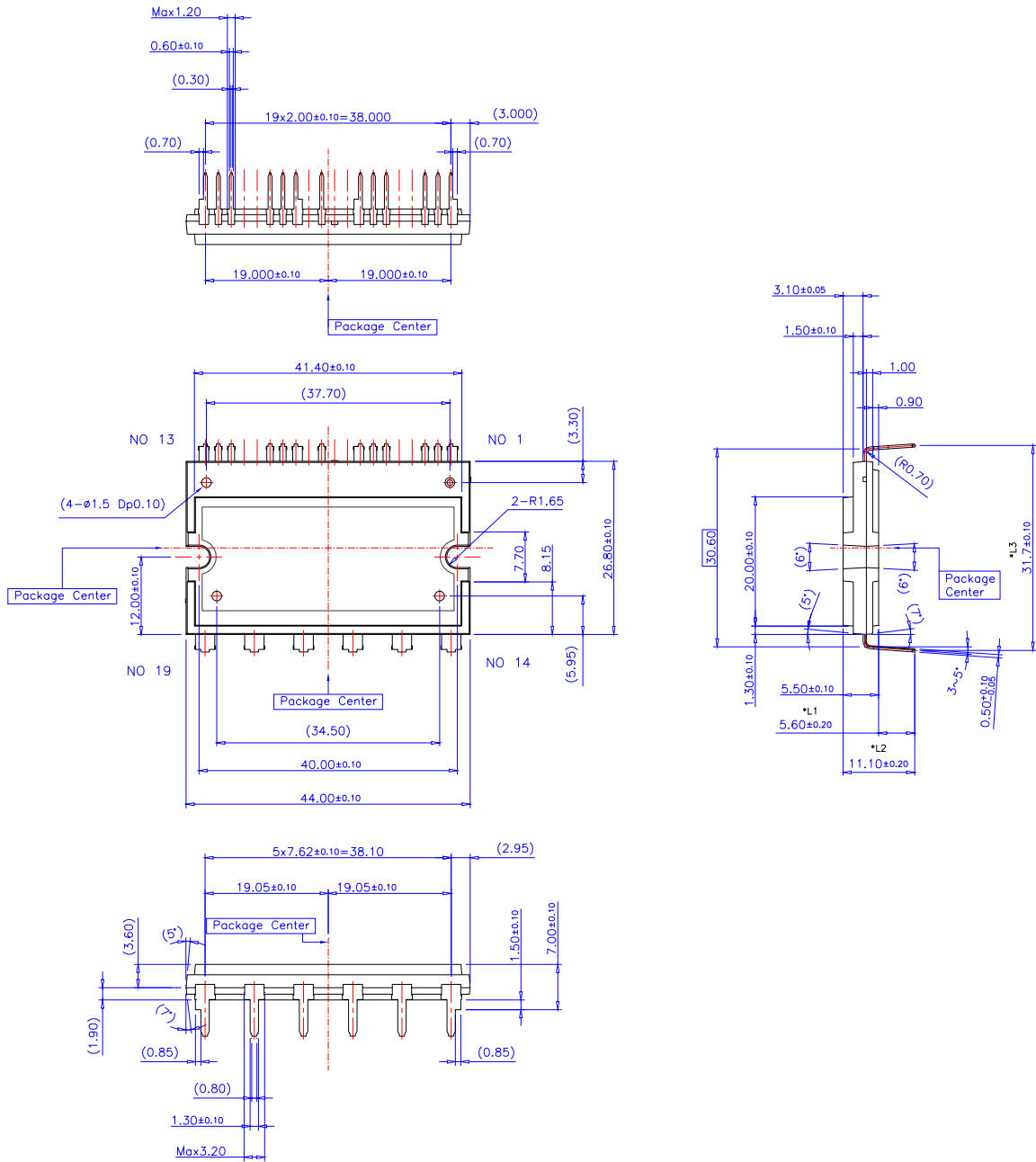



Figure 11.



TRADEMARKS

The following are registered and unregistered trademarks Fairchild Semiconductor owns or is authorized to use and is not intended to be an exhaustive list of all such trademarks.

ACEx [®]	GlobalOptoisolator [™]	Power247 [®]	SyncFET [™]
Across the board. Around the world. [™]	GTO [™]	PowerEdge [™]	TCM [™]
ActiveArray [™]	HiSeC [™]	PowerSaver [™]	The Power Franchise [®]
Bottomless [™]	<i>i-Lo</i> [™]	PowerTrench [®]	
Build it Now [™]	ImpliedDisconnect [™]	Programmable Active Droop [™]	TinyBoost [™]
CoolFET [™]	IntelliMAX [™]	QFET [®]	TinyBuck [™]
CROSSVOLT [™]	ISOPLANAR [™]	QS [™]	TinyLogic [®]
CTL [™]	MICROCOUPLER [™]	QT Optoelectronics [™]	TINYOPTO [™]
Current Transfer Logic [™]	MicroPak [™]	Quiet Series [™]	TinyPower [™]
DOME [™]	MICROWIRE [™]	RapidConfigure [™]	TinyWire [™]
E ² CMOST [™]	MSX [™]	RapidConnect [™]	TruTranslation [™]
EcoSPARK [®]	MSXPro [™]	ScalarPump [™]	μSerDes [™]
EnSigna [™]	OCX [™]	SMART START [™]	UHC [®]
FACT Quiet Series [™]	OCXPro [™]	SPM [®]	UniFET [™]
FACT [®]	OPTOLOGIC [®]	STEALTH [™]	VCX [™]
FAST [®]	OPTOPLANAR [®]	SuperFET [™]	Wire [™]
FASTr [™]	PACMAN [™]	SuperSOT [™] -3	
FPS [™]	POP [™]	SuperSOT [™] -6	
FRFET [®]	Power220 [®]	SuperSOT [™] -8	

DISCLAIMER

FAIRCHILD SEMICONDUCTOR RESERVES THE RIGHT TO MAKE CHANGES WITHOUT FURTHER NOTICE TO ANY PRODUCTS HEREIN TO IMPROVE RELIABILITY, FUNCTION, OR DESIGN. FAIRCHILD DOES NOT ASSUME ANY LIABILITY ARISING OUT OF THE APPLICATION OR USE OF ANY PRODUCT OR CIRCUIT DESCRIBED HEREIN; NEITHER DOES IT CONVEY ANY LICENSE UNDER ITS PATENT RIGHTS, NOR THE RIGHTS OF OTHERS. THESE SPECIFICATIONS DO NOT EXPAND THE TERMS OF FAIRCHILD'S WORLDWIDE TERMS AND CONDITIONS, SPECIFICALLY THE WARRANTY THEREIN, WHICH COVERS THESE PRODUCTS.

LIFE SUPPORT POLICY

FAIRCHILD'S PRODUCTS ARE NOT AUTHORIZED FOR USE AS CRITICAL COMPONENTS IN LIFE SUPPORT DEVICES OR SYSTEMS WITHOUT THE EXPRESS WRITTEN APPROVAL OF FAIRCHILD SEMICONDUCTOR CORPORATION.

As used herein:

- Life support devices or systems are devices or systems which, (a) are intended for surgical implant into the body, or (b) support or sustain life, and (c) whose failure to perform when properly used in accordance with instructions for use provided in the labeling, can be reasonably expected to result in significant injury to the user.
- A critical component is any component of a life support device or system whose failure to perform can be reasonably expected to cause the failure of the life support device or system, or to affect its safety or effectiveness.

PRODUCT STATUS DEFINITIONS

Definition of Terms

Datasheet Identification	Product Status	Definition
Advance Information	Formative or In Design	This datasheet contains the design specifications for product development. Specifications may change in any manner without notice.
Preliminary	First Production	This datasheet contains preliminary data; supplementary data will be published at a later date. Fairchild Semiconductor reserves the right to make changes at any time without notice to improve design.
No Identification Needed	Full Production	This datasheet contains final specifications. Fairchild Semiconductor reserves the right to make changes at any time without notice to improve design.
Obsolete	Not In Production	This datasheet contains specifications on a product that has been discontinued by Fairchild semiconductor. The datasheet is printed for reference information only.