



M20-089114-45

2" Square / 50.8mm Square Waffle Tray (BLACK)

Features:

- Static Protective
- Tight Dimensional Pocket Tolerance
- Durable Material Construction

Component Applications:

- Thin Film & Chip Level / Known Good Die (KGD)
- Passive and Active Chip Components
- Opto Electronics and Mechanical Components

Waffle Tray Diagram

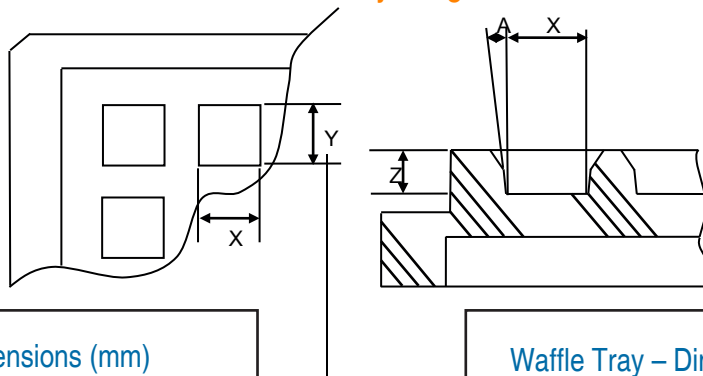

Waffle Tray - Dimensions (mm)

Technical Spec (mm)

X = 2.29mm ±0.13mm pocket size
 Y = 2.92mm ±0.13mm pocket size
 Z = 1.14mm ±0.05mm pocket depth
 A = 5° ±1/2° pocket draft angle
 No Cross Slots
 Array = 15 X 12 (180)

Overall Tray Size:

Size = 50.67mm ±0.25mm
 Height = 3.94mm +0.08mm -0.13mm
 Flatness = 0.30mm

Waffle Tray – Dimensions (Inches)

Technical Spec (inches)

X = 0.090" ±0.005" pocket size
 Y = 0.115" ±0.005" pocket size
 Z = 0.045" ±0.003" pocket depth
 A = 5° ±1/2° pocket draft angle
 No Cross Slots
 Array = 15 X 12 (180)

Overall Tray Size:

Size = 1.995" ±0.010"
 Height = 0.155" +0.003" -0.005"
 Flatness = 0.012"

Buy M20-089114-45 Waffle Tray Pack Online

Micross Kit Includes – Tray, Lid, Tyvek Paper and Clip

Tray Material	Polypropylene with Carbon Powder and Glass Bead
Surface Resistivity	10 ¹ - 10 ⁵
Static Delay Time (sec.)	<0.01
Temperature Limit	70°C
Lid Material	Polypropylene with Carbon Powder and Glass Bead
Clip Material	Polypropylene with Carbon Powder