

ATV30C5V0-G Thru. ATV30C441-G

Working Peak Reverse Voltage: 5.0 to 440 Volts

Power Dissipation: 3000 Watts

RoHS Device

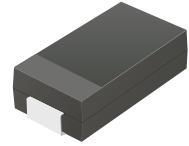

Features

- Ideally for surface mount applications.
- Easy pick and place.
- Plastic package has Underwriters Lab. flammability classification 94V-0.
- Typical IR less than 1µA above 10V.
- Fast response time: typically less than 1nS for uni-direction, less than 5nS for bi-direction, from 0V to BV min.
- Comply with AEC-Q101
- Use in sensitive electronic protection against voltage transients induced by inductive load switching and lighting on ICs, MOSFET, signal lines of sensor units for consumer, computer, industrial, automotive and telecommunication.

Mechanical data

- Case: JEDEC DO-214AB, molded plastic.
- Terminals: solderable per MIL-STD-750, method 2026.
- Polarity: Color band denotes cathode end except Bipolar.
- Approx. weight: 0.21 grams

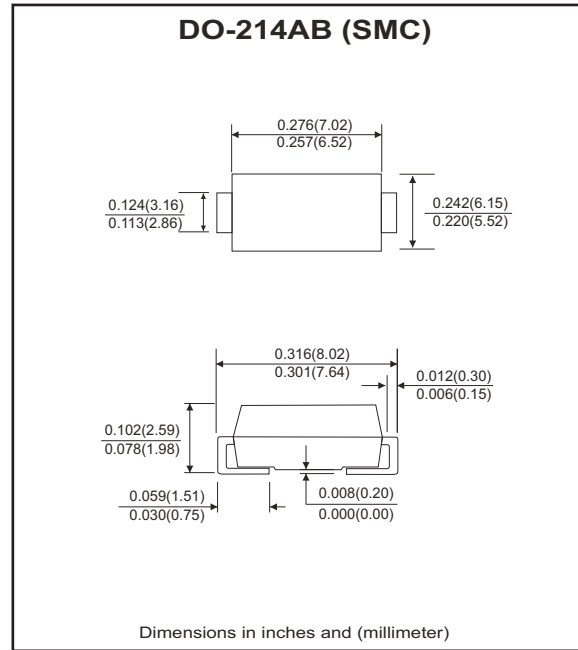

Maximum Ratings and Electrical Characteristics

Rating at 25°C ambient temperature unless otherwise specified.
Single phase, half wave, 60Hz, resistive or inductive load.
For capacitive load, derate current by 20%.

Characteristics	Symbol	Value	Units
Peak power dissipation on 10/1000µS waveform (Note 1)	P _{PP}	3000	W
Peak pulse current on 10/1000µS waveform (Note 1)	I _{PP}	See Next Table	A
Steady state power dissipation at T _L =75°C	P _D	6.0	W
Peak forward surge current, 8.3ms single half sine-wave superimposed on rated load, uni-directional only (Note 2)	I _{FSM}	300	A
Maximum instantaneous forward voltage at 100A for uni-directional only (Note 3)	V _F	3.5/5.0	V
Operating junction temperature	T _J	-55 to +150	°C
Storage temperature range	T _{STG}	-55 to +150	°C

Notes:

1. Non-repetitive current pulse, per Fig. 5 and derated above T_A=25 °C, per Fig. 1
2. Measured on 8.3 ms single half sine-wave or equivalent square wave, duty cycle=4 pulses per minute maximum.
3. V_F<3.5V for devices of V_{BR}<200V and V_F<5.0V for devices of V_{BR}>201V

Company reserves the right to improve product design , functions and reliability without notice.

REV:A

RATING AND CHARACTERISTIC CURVES (ATV30C5V0-G Thru. ATV30C441-G)

Fig.1- Pulse Derating Curve

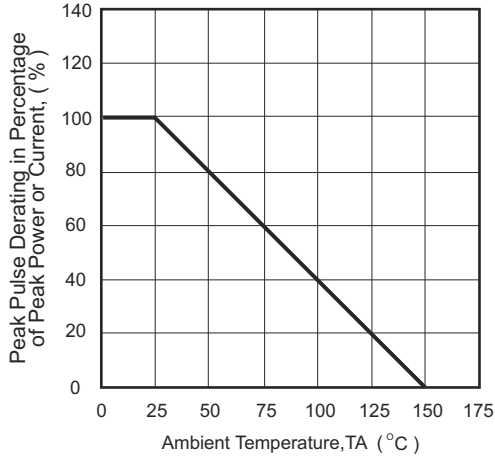

Fig.2- Max. Non-Repetitive Surge Current

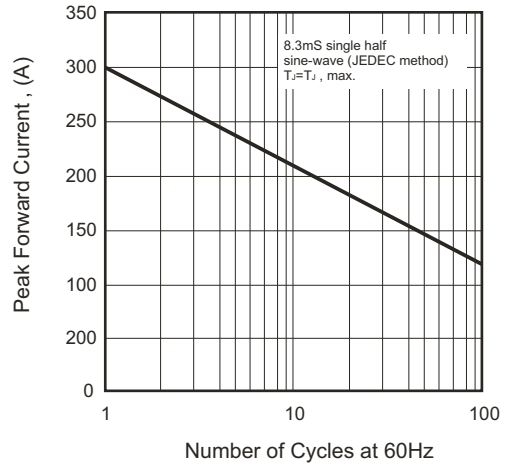

Fig.3- Steady State Power Derating Curve

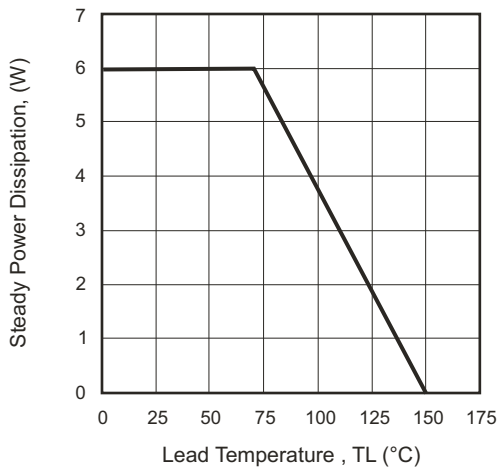

Fig.4- Peak Pulse Power Rating Curve

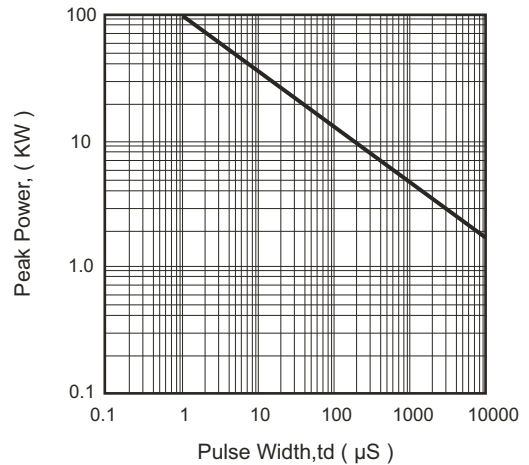

Fig.5- Pulse Waveform

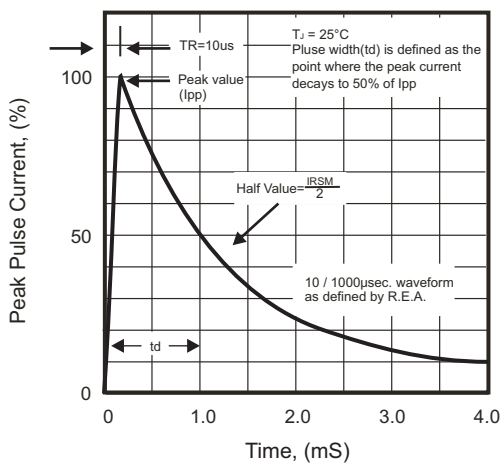
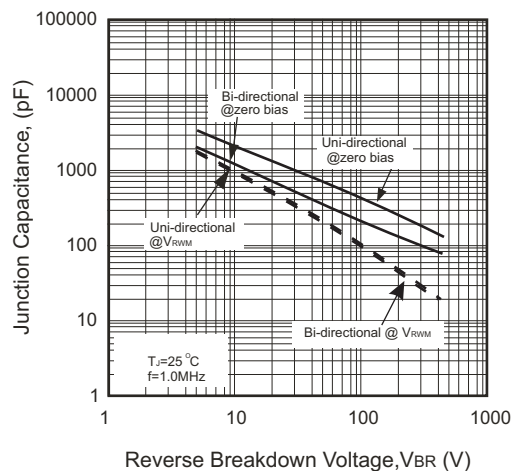

Fig.6- Typical Junction Capacitance



SMD Transient Voltage Suppressor



Electrical Characteristics (ATV30C5V0-G Thru. ATV30C441-G)

Part No	Absolute Maximum Rating (Ta= 25°C)					Electrical Characteristic (Ta= 25°C)				
	V _{RWM}	V _{BR} Min.	V _{BR} Max.	I _T	I _{FSM}	Max. V _C		I _R @V _{RWM}	Marking Code	
	(V)	(V)	(V)	(mA)	(A)@8.3mS	(V)	I _{PP} (A)	(μ A)	Uni	Bi
ATV30C5V0J(B)-G	5.0	6.40	7.00	50	300	9.2	326.09	5000	RDE	DDE
ATV30C6V0J(B)-G	6.0	6.67	7.37	50	300	10.3	291.26	5000	RDG	DDG
ATV30C6V5J(B)-G	6.5	7.22	7.98	50	300	11.2	267.86	2000	RDK	DDK
ATV30C7V0J(B)-G	7.0	7.78	8.60	50	300	12.0	250.00	1000	PDM	DDM
ATV30C7V5J(B)-G	7.5	8.33	9.21	5	300	12.9	232.56	250	PDP	DDP
ATV30C8V0J(B)-G	8.0	8.89	9.83	5	300	13.6	220.59	150	PDR	DDR
ATV30C8V5J(B)-G	8.5	9.44	10.40	5	300	14.4	208.33	50	PDT	DDT
ATV30C9V0J(B)-G	9.0	10.00	11.10	5	300	15.4	194.81	20	PDV	DDV
ATV30C100J(B)-G	10.0	11.10	12.30	5	300	17.0	176.47	15	PDX	DDX
ATV30C110J(B)-G	11.0	12.20	13.50	5	300	18.2	164.84	2	PDZ	DDZ
ATV30C120J(B)-G	12.0	13.30	14.70	5	300	19.9	150.75	2	PEE	DEE
ATV30C130J(B)-G	13.0	14.40	15.90	5	300	21.5	139.53	2	PEG	DEG
ATV30C140J(B)-G	14.0	15.60	17.20	5	300	23.2	129.31	2	PEK	DEK
ATV30C150J(B)-G	15.0	16.70	18.50	5	300	24.4	122.95	2	PEM	DEM
ATV30C160J(B)-G	16.0	17.80	19.70	5	300	26.0	115.38	2	PEP	DEP
ATV30C170J(B)-G	17.0	18.90	20.90	5	300	27.6	108.70	2	PER	DER
ATV30C180J(B)-G	18.0	20.00	22.10	5	300	29.2	102.74	2	PET	DET
ATV30C190J(B)-G	19.0	21.10	23.30	5	300	30.8	97.47	2	PEB	DEB
ATV30C200J(B)-G	20.0	22.20	24.50	5	300	32.4	92.59	2	PEV	DEV
ATV30C220J(B)-G	22.0	24.40	26.90	5	300	35.5	84.51	2	PEX	DEX
ATV30C240J(B)-G	24.0	26.70	29.50	5	300	38.9	77.12	2	PEZ	DEZ
ATV30C260J(B)-G	26.0	28.90	31.90	5	300	42.1	71.26	2	PFE	DFE
ATV30C280J(B)-G	28.0	31.10	34.40	5	300	45.4	66.08	2	PFG	DFG
ATV30C300J(B)-G	30.0	33.30	36.80	5	300	48.4	61.98	2	PFK	DFK
ATV30C330J(B)-G	33.0	36.70	40.60	5	300	53.3	56.29	2	PFM	DFM
ATV30C360J(B)-G	36.0	40.00	44.20	5	300	58.1	51.64	2	PFV	DFV
ATV30C400J(B)-G	40.0	44.40	49.10	5	300	64.5	46.51	2	PFR	DFR
ATV30C430J(B)-G	43.0	47.80	52.80	5	300	69.4	43.23	2	PFT	DFT
ATV30C450J(B)-G	45.0	50.00	55.30	5	300	72.7	41.27	2	PFV	DFV
ATV30C480J(B)-G	48.0	53.30	58.90	5	300	77.4	38.76	2	PFX	DFX
ATV30C510J(B)-G	51.0	56.70	62.70	5	300	82.4	36.41	2	PFZ	DFZ
ATV30C540J(B)-G	54.0	60.00	66.30	5	300	87.1	34.44	2	RGE	DGE
ATV30C580J(B)-G	58.0	64.40	71.20	5	300	93.6	32.05	2	PGG	DGG
ATV30C600J(B)-G	60.0	66.70	73.70	5	300	96.8	30.99	2	PGK	DGK
ATV30C640J(B)-G	64.0	71.10	78.60	5	300	103.0	29.13	2	PGM	DGM
ATV30C700J(B)-G	70.0	77.80	86.00	5	300	113.0	26.55	2	PGP	DGP
ATV30C750J(B)-G	75.0	83.30	92.10	5	300	121.0	24.79	2	PGR	DGR
ATV30C780J(B)-G	78.0	86.70	95.80	5	300	126.0	23.81	2	PGT	DGT
ATV30C800J(B)-G	80.0	88.80	97.60	5	300	129.6	23.15	2	PGB	DGB
ATV30C850J(B)-G	85.0	94.40	104.00	5	300	137.0	21.90	2	PGV	DGV
ATV30C900J(B)-G	90.0	100.00	111.00	5	300	146.0	20.55	2	PGX	DGX
ATV30C101J(B)-G	100.0	111.00	123.00	5	300	162.0	18.52	2	PGZ	DGZ
ATV30C111J(B)-G	110.0	122.00	135.00	5	300	177.0	16.95	2	PHE	DHE
ATV30C121J(B)-G	120.0	133.00	147.00	5	300	193.0	15.54	2	PHG	DHG
ATV30C131J(B)-G	130.0	144.00	159.00	5	300	209.0	14.35	2	PHK	DHK
ATV30C141J(B)-G	140.0	155.00	171.00	5	300	226.8	13.23	2	PHB	DHB
ATV30C151J(B)-G	150.0	167.00	185.00	5	300	243.0	12.35	2	PHM	DHM
ATV30C161J(B)-G	160.0	178.00	197.00	5	300	259.0	11.58	2	PHP	DHP

Company reserves the right to improve product design , functions and reliability without notice.

REV:A

SMD Transient Voltage Suppressor



Electrical Characteristics (ATV30C5V0-G Thru. ATV30C441-G)

Part No.	Absolute Maximum Rating (T _A = 25°C)					Electrical Characteristic (T _A =25°C)				
	V _{RWM}	V _{BR} Min.	V _{BR} Max.	I _T	I _{FSM}	Max V _C	I _R @V _{RWM}	Marking Code		
	(V)	(V)	(V)	(mA)	(A)@8.3mS	(V)	I _{PP} (A)	(uA)	Uni	Bi
ATV30C171J(B)-G	170.0	189.00	209.0	5	300	275.0	10.91	2	PHR	DHR
ATV30C181J(B)-G	180.0	200.00	220.00	5	300	291.6	10.29	2	PHT	DHT
ATV30C191J(B)-G	190.0	211.00	232.00	5	300	307.8	9.75	2	PHV	DHV
ATV30C201J(B)-G	200.0	224.00	247.00	5	300	324.0	9.26	2	PHW	DHW
ATV30C221J(B)-G	220.0	246.00	272.00	5	300	356.0	8.43	2	PHX	DHX
ATV30C251J(B)-G	250.0	279.00	309.00	5	300	405.0	7.41	2	PHZ	DHZ
ATV30C301J(B)-G	300.0	335.00	371.00	5	300	486.0	6.17	2	PJE	DJE
ATV30C351J(B)-G	350.0	391.00	432.00	5	300	567.0	5.29	2	PJG	DJG
ATV30C401J(B)-G	400.0	447.00	494.00	5	300	648.0	4.63	2	PJK	DJK
ATV30C441J(B)-G	440.0	492.00	543.00	5	300	713.0	4.21	2	PJM	DJM

Note:

- 1) Suffix J denotes 5% tolerance devices.
- 2) Suffix B after part number to specify Bi-directional devices.
- 3) For Bi-Directional devices having V_R of 10 volts and under, the I_R limit is double.

Reel Taping Specification

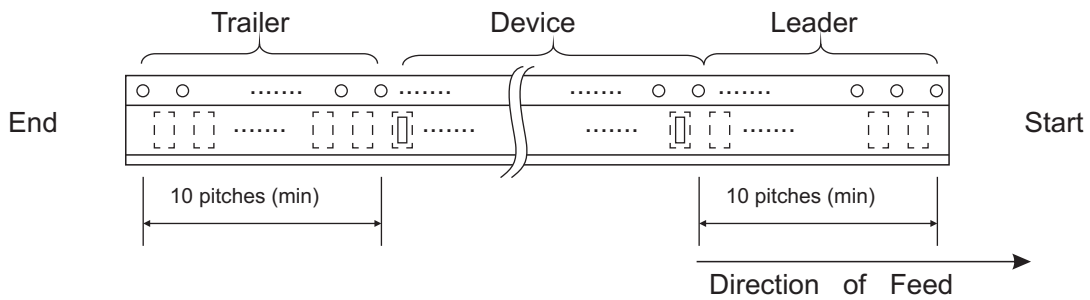
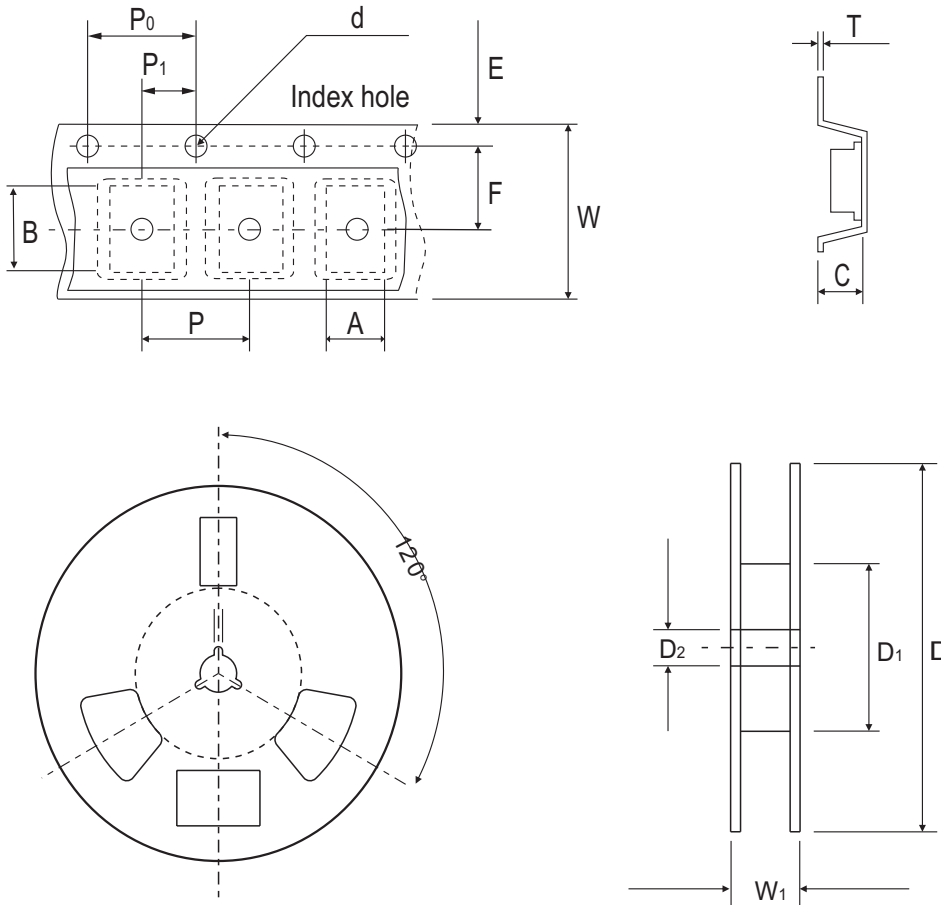

DO-214AB (SMC)	SYMBOL	A	B	C	d	D	D ₁	D ₂
	(mm)	6.05 ± 0.10	8.31 ± 0.10	4.50 (max)	1.55 ± 0.10-0.0	330	50.0 MIN.	13.0 ± 0.20
	(inch)	0.256 ± 0.004	0.327 ± 0.004	0.177 (max)	0.061 ± 0.004	13.00	1.969 MIN.	0.512 ± 0.008

DO-214AB (SMC)	SYMBOL	E	F	P	P ₀	P ₁	W	W ₁
	(mm)	1.75 ± 0.10	7.50 ± 0.05	4.00 ± 0.10	4.00 ± 0.10	2.00 ± 1.00	16.0 ± 0.30	22.4 MAX.
	(inch)	0.069 ± 0.004	0.295 ± 0.002	0.157 ± 0.004	0.157 ± 0.004	0.079 ± 0.040	0.630 ± 0.012	0.882 MAX.

Marking Code

1. C: COMCHIP
2. ○: Package

○	PKG
C	SMC

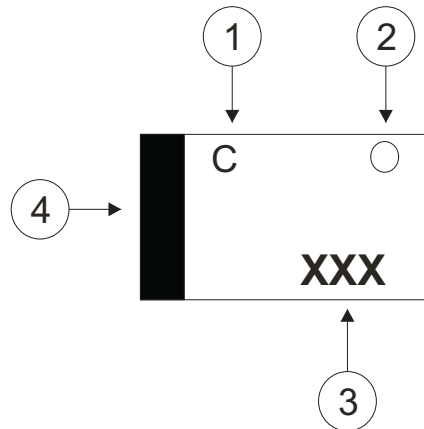

3. XXX: Marking code(see Page. 3~5)
4. █: Cathod Band

Suggested PAD Layout

SIZE	DO-214AB(SMC)	
	(mm)	(inch)
A	8.13	0.320
B	4.69 MAX	0.185 MAX
C	1.52 MIN	0.06 MIN
D	3.20 MIN	0.126 MIN

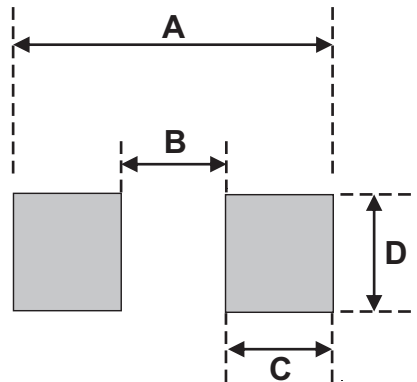

Standard Packaging

Case Type	REEL PACK	
	REEL (pcs)	Reel Size (inch)
DO-214AB (SMC)	3,000	13