

TOSHIBA LED LAMP

**TLRE1005A (T03), TLOE1005A (T03), TLYE1005A (T03), TLSU1005A (T03)
TLOU1005A (T03), TLYU1005A (T03), TLGD1005A (T03)**

PANEL CIRCUIT INDICATOR

Unit in mm

- Surface Mount Device
- 3.2 (L) × 2.4 (W) × 2.4 (H) mm Size
- ϕ 2 mm Lens-top type
- Small Package - High Density Mounting is Available
- It can be manufactured high-luminosity of equipment or reduce of electric power consumption by change in the high-luminosity LED from general-luminosity one.
- Colors : Red, Orange, Yellow, Green
- Suitable Auto-mounting Machine Use
- Reflow Soldering is possible.
- Standard Embossed Taping
4 mm Pitch : T03 (1000 pcs / Reel)
- Applications : Portable Equipment
Message Signboards
High Intensity Backlight
Battery-Driven Equipment, etc.

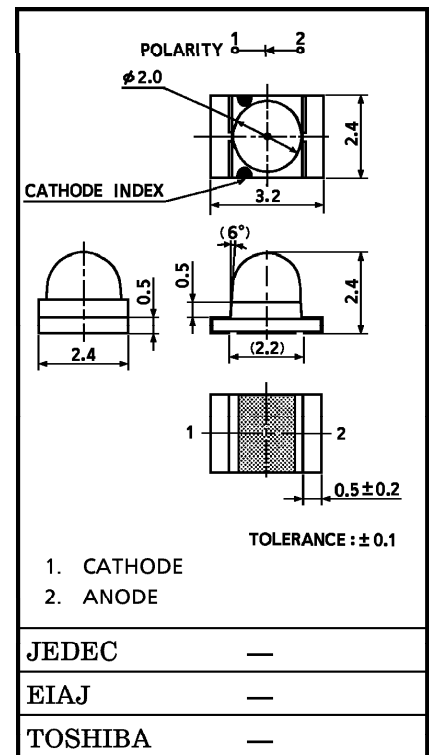

Weight : 17 mg

LINE-UP

PRODUCT NAME	COLOR	MATERIAL
TLRE1005A	Red	InGaAlP
TLSU1005A	Red	InGaAlP
TLOE1005A	Orange	InGaAlP
TLOU1005A	Orange	InGaAlP
TLYE1005A	Yellow	InGaAlP
TLYU1005A	Yellow	InGaAlP
TLGD1005A	Green	GaP

MAXIMUM RATINGS (Ta = 25°C)

PRODUCT NAME	FORWARD CURRENT (DC) I _F (mA)	REVERSE VOLTAGE V _R (V)	POWER DISSIPATION P _D (mW)	OPERATING TEMPERATURE T _{opr} (°C)	STORAGE TEMPERATURE T _{stg} (°C)
TLRE1005A	25	4	60	-25~80	-30~85
TLSU1005A	25	4	60		
TLOE1005A	25	4	60		
TLOU1005A	25	4	60		
TLYE1005A	25	4	62.5		
TLYU1005A	25	4	62.5		
TLGD1005A	25	4	62.5		

ELECTRICAL CHARACTERISTICS (Ta = 25°C)

PRODUCT NAME	FORWARD VOLTAGE V _F				REVERSE CURRENT I _R	
	MIN	TYP.	MAX	I _F	MAX	V _R
TLRE1005A	—	1.85	2.4	20	50	4
TLSU1005A	—	2.0	2.4	20	50	4
TLOE1005A	—	1.95	2.4	20	50	4
TLOU1005A	—	2.0	2.4	20	50	4
TLYE1005A	—	2.1	2.5	20	50	4
TLYU1005A	—	2.1	2.5	20	50	4
TLGD1005A	—	2.1	2.5	20	5	4
Unit	V			mA	μA	V

OPTICAL CHARACTERISTICS (Ta = 25°C)

PRODUCT NAME	LUMINOUS INTENSITY I _v			
	MIN	TYP.	MAX	I _F
TLRE1005A	153	450	—	20
TLSU1005A	153	450	—	20
TLOE1005A	153	400	—	20
TLOU1005A	153	450	—	20
TLYE1005A	85	300	—	20
TLYU1005A	47.6	140	—	20
TLGD1005A	27.2	75	—	20
Unit	mcd			mA

PRODUCT NAME	EMISSION SPECTRUM							I _F
	Peak Emission Wavelength λ _p			Δλ TYP.	Dominant Wavelength λ _d			
	MIN	TYP.	MAX		MIN	TYP.	MAX	
TLRE1005A	—	644	—	18	—	630	—	20
TLSU1005A	—	636	—	17	—	623	—	20
TLOE1005A	—	612	—	15	—	605	—	20
TLOU1005A	—	612	—	15	—	605	—	20
TLYE1005A	—	590	—	13	—	587	—	20
TLYU1005A	—	590	—	13	—	587	—	20
TLGD1005A	—	570	—	20	—	(571)	—	20
Unit	nm			nm	nm			mA

(Note) : This visible LED lamp also emits some IR light.
 If a photodetector is located near the LED lamp, please ensure that it will not be affected by this IR light.

TLRE1005A

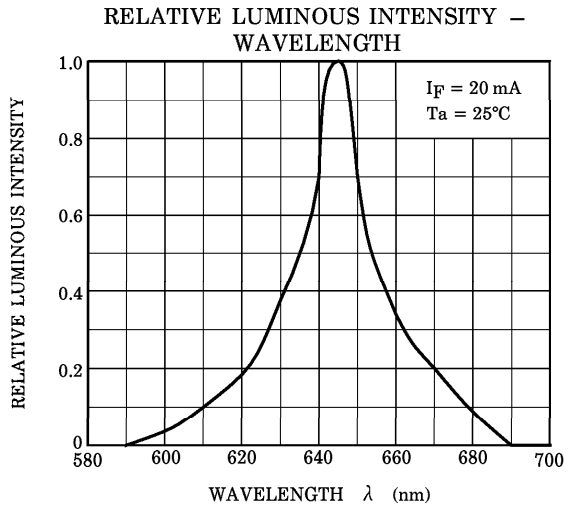
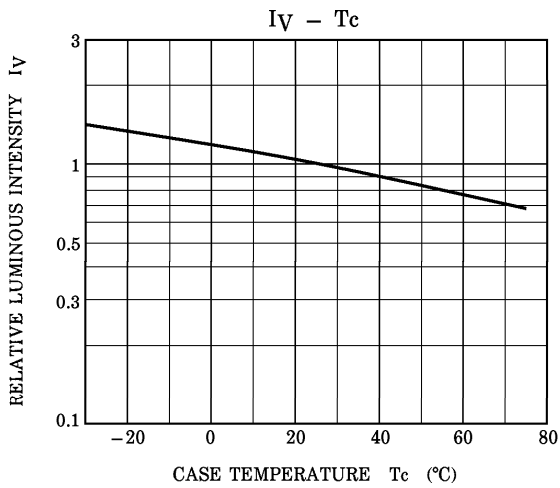
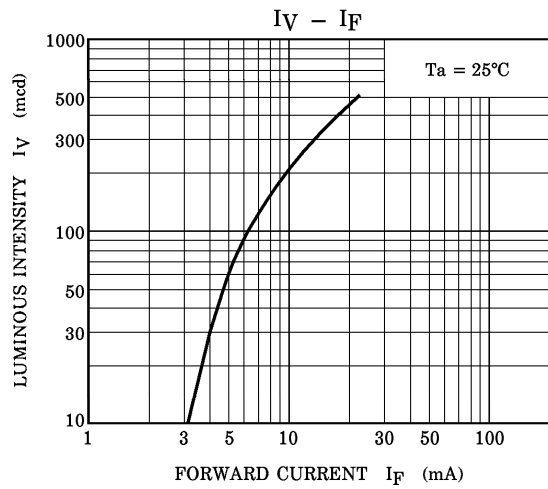
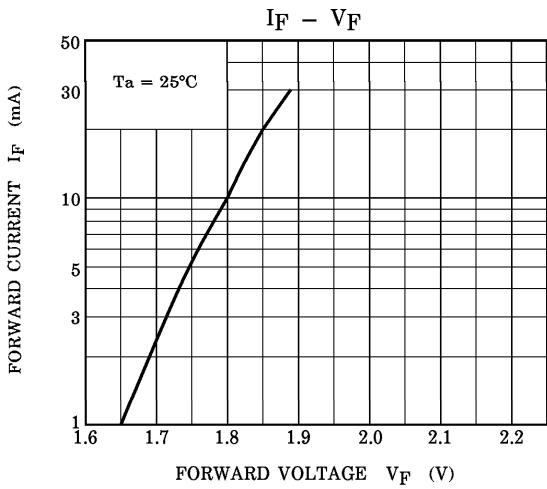

RADIATION PATTERN

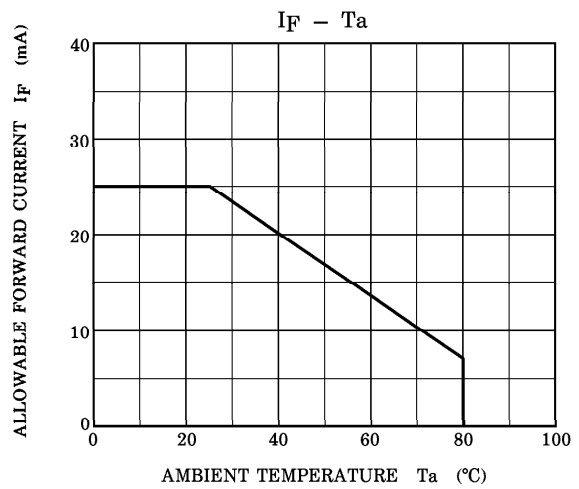
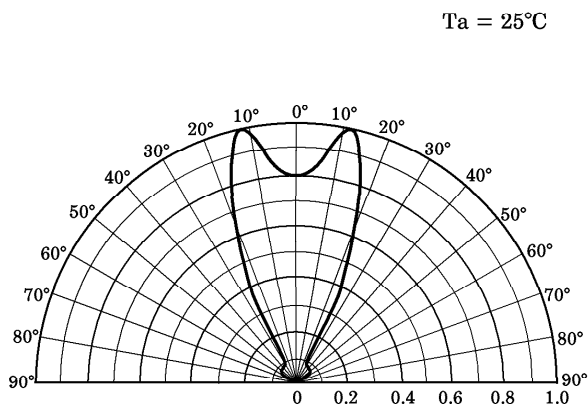

TLSU1005A

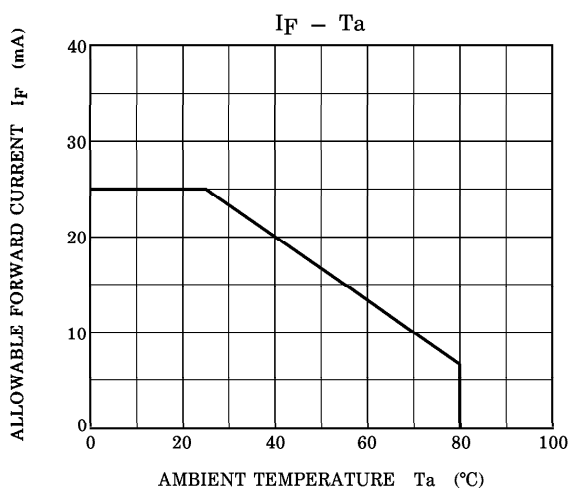
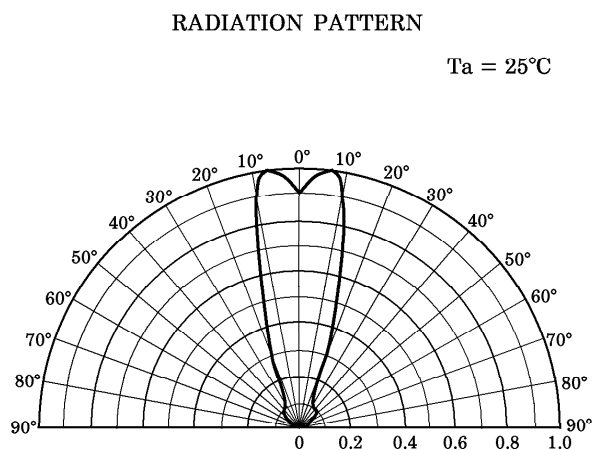
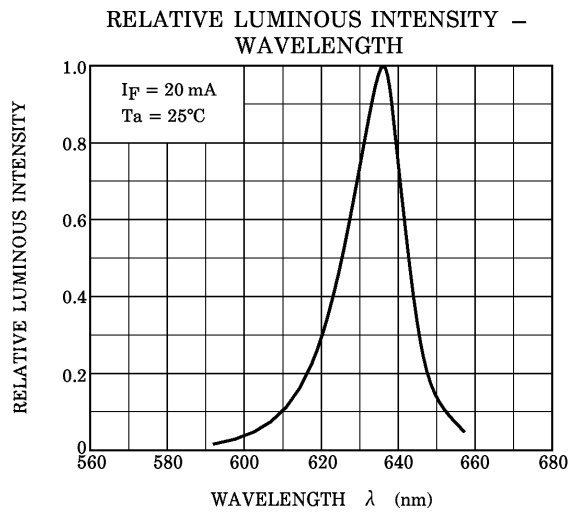
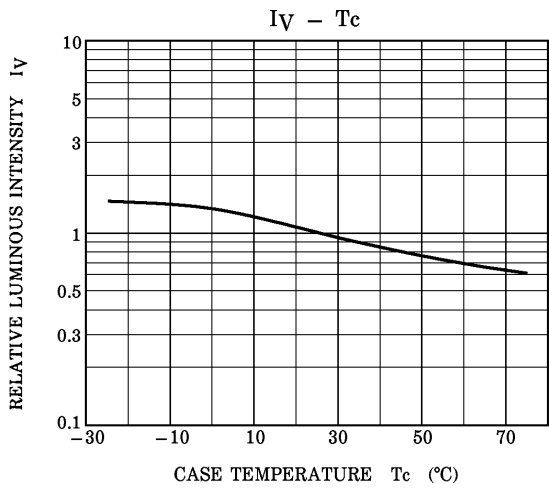
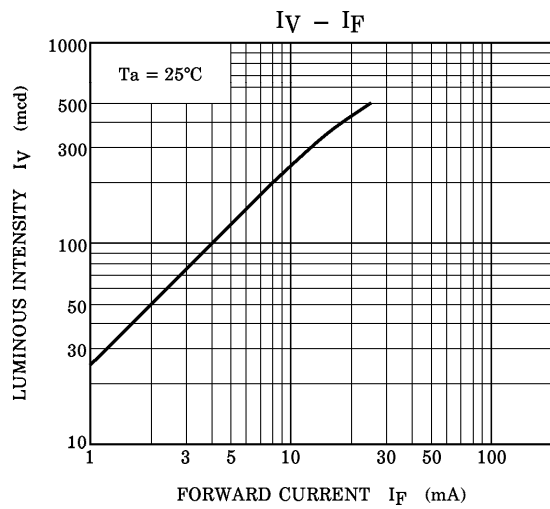
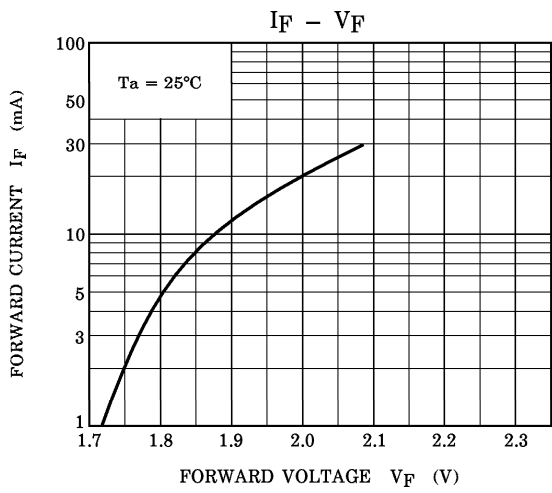

TLOE1005A

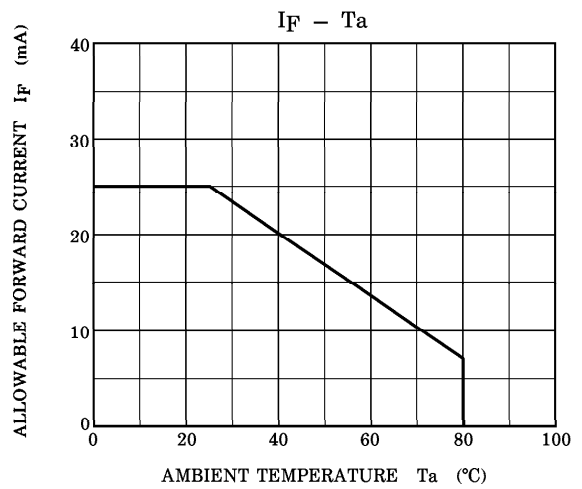
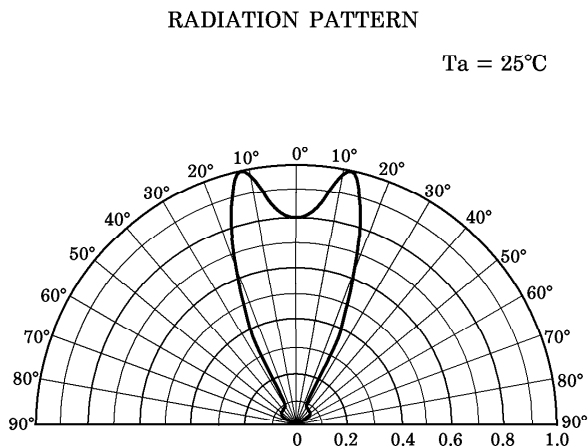
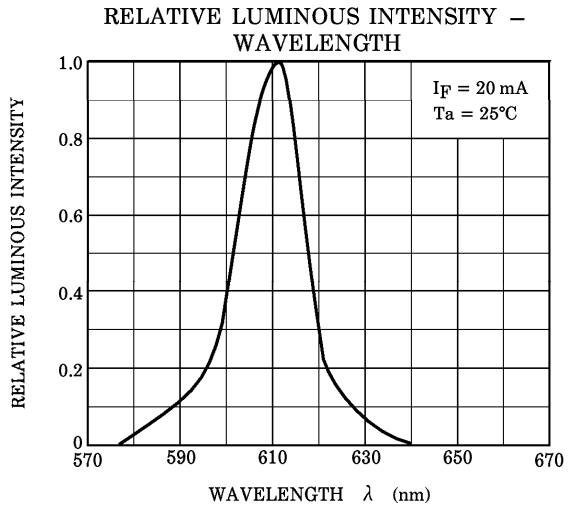
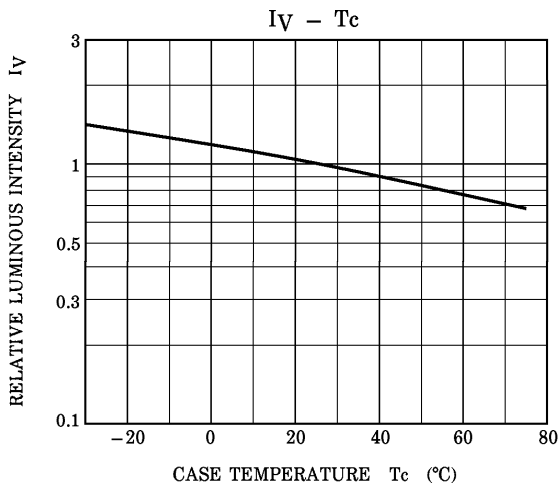
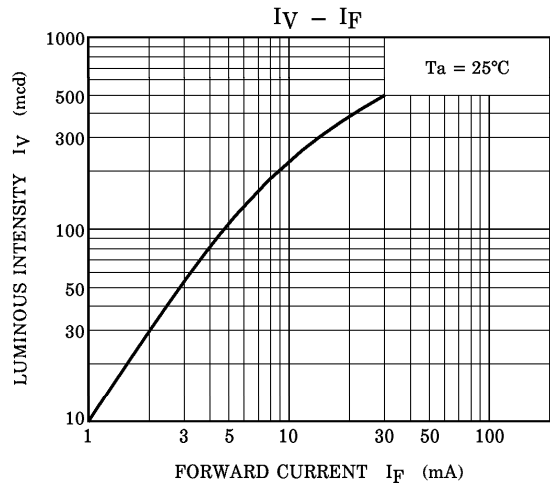
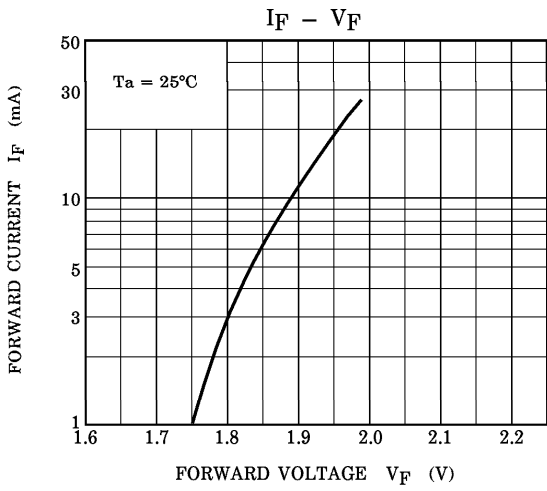

TLOU1005A

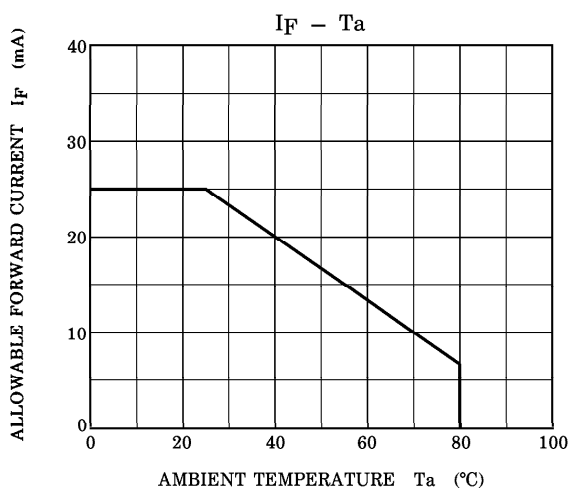
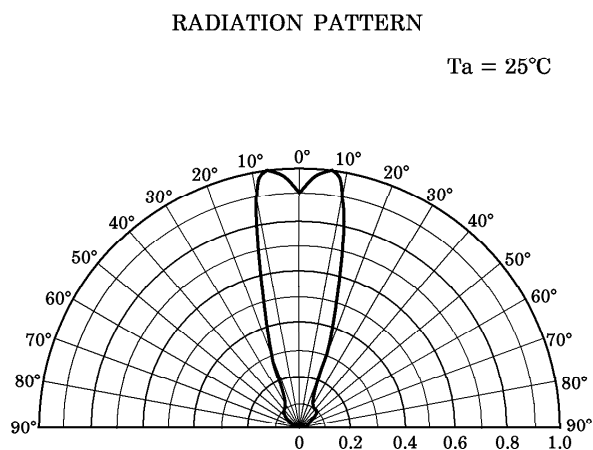
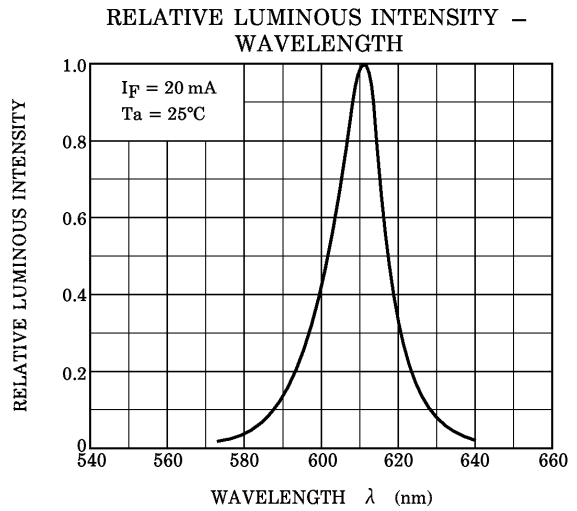
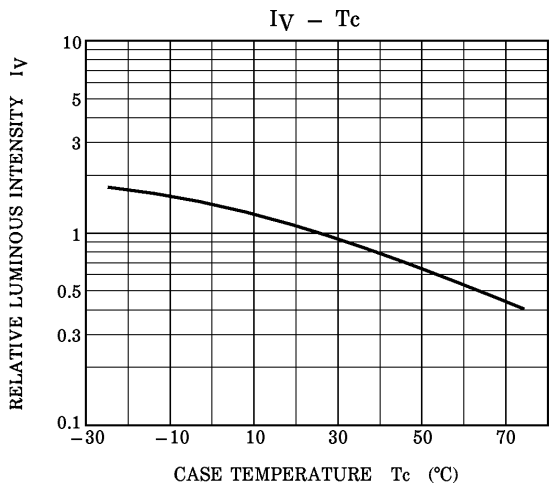
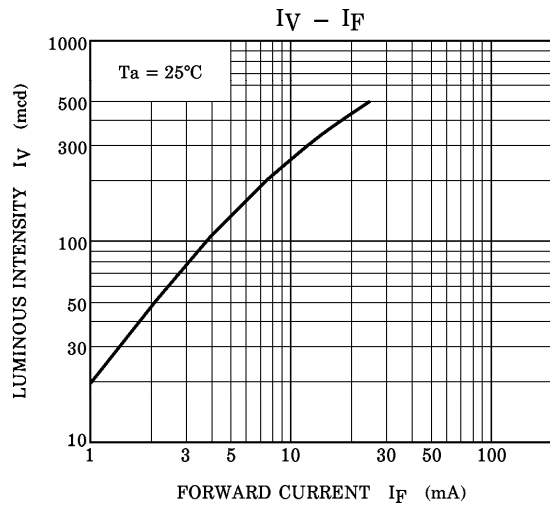
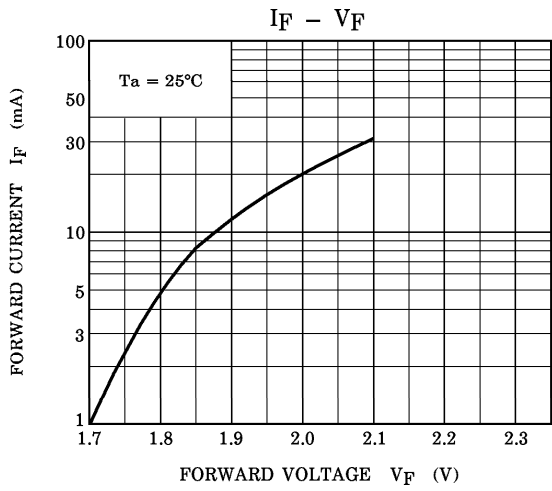

TLYE1005A

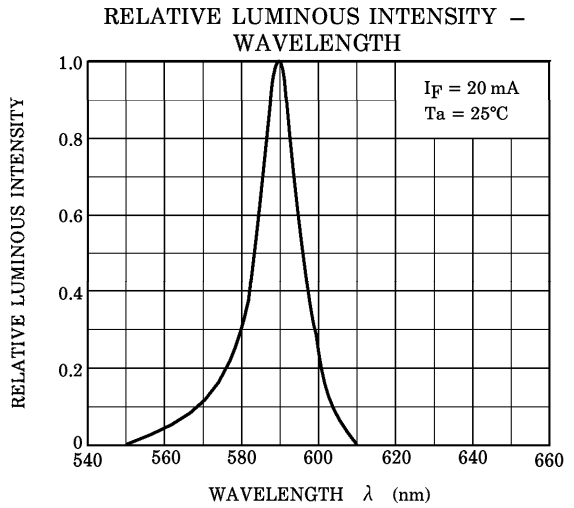
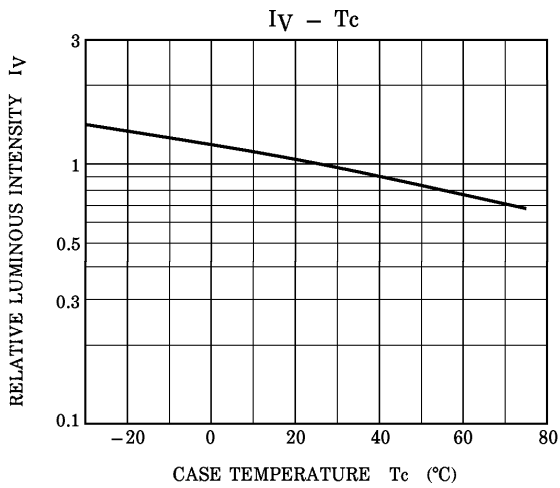
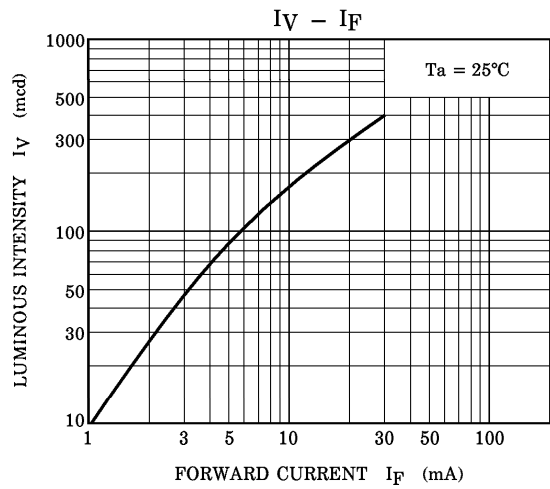
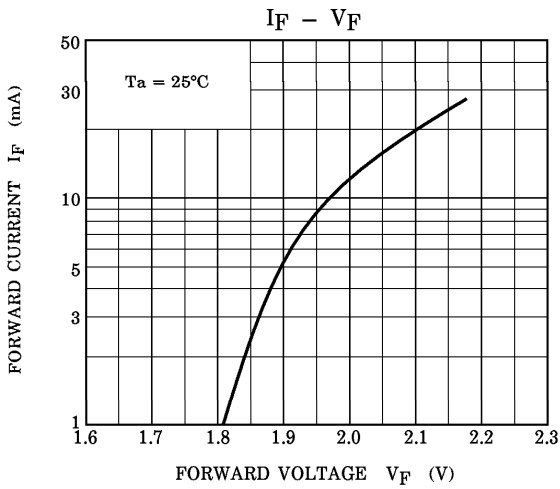

RADIATION PATTERN

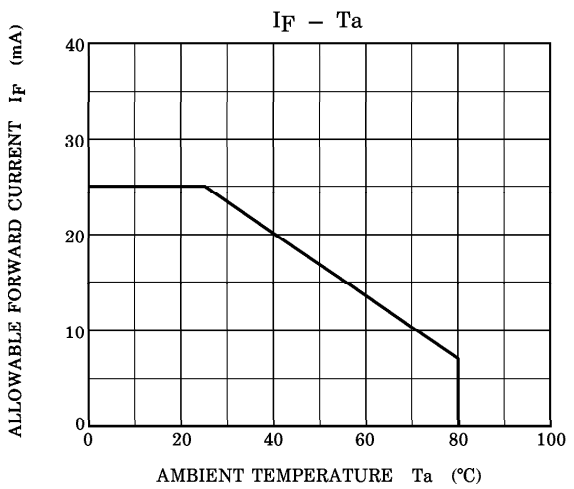
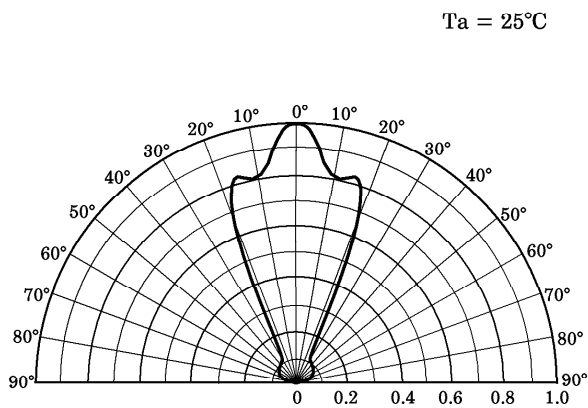

TLYU1005A

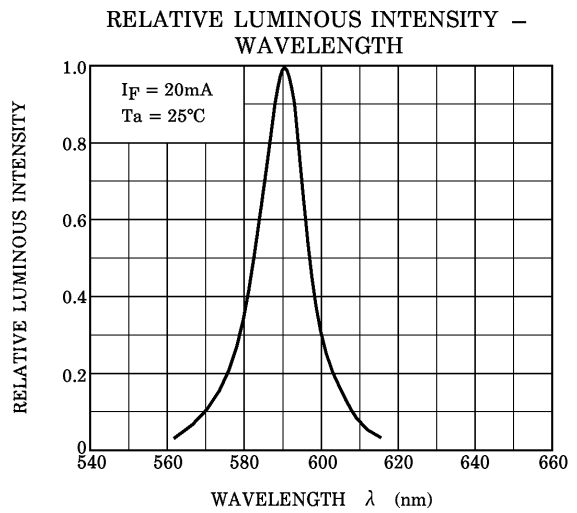
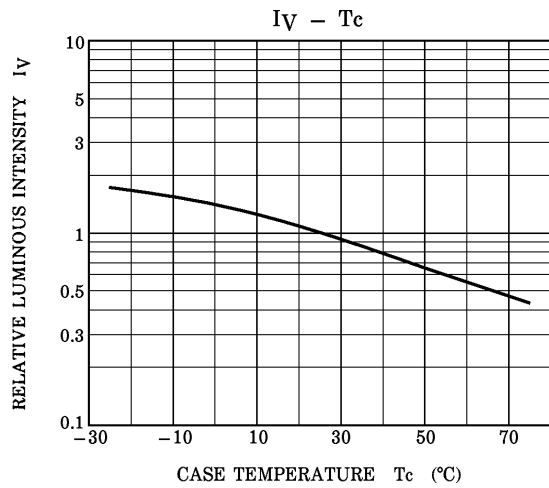
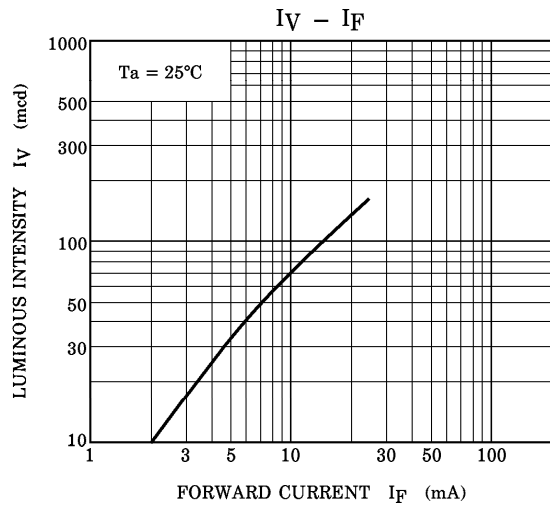
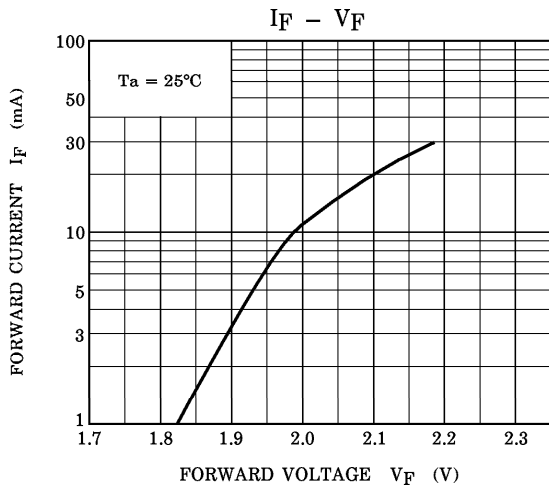

RADIATION PATTERN

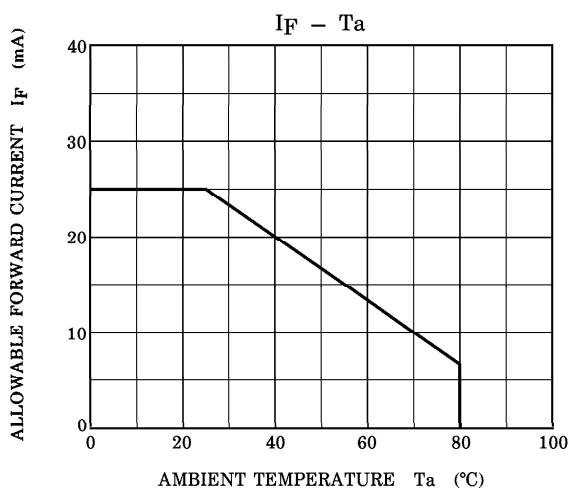
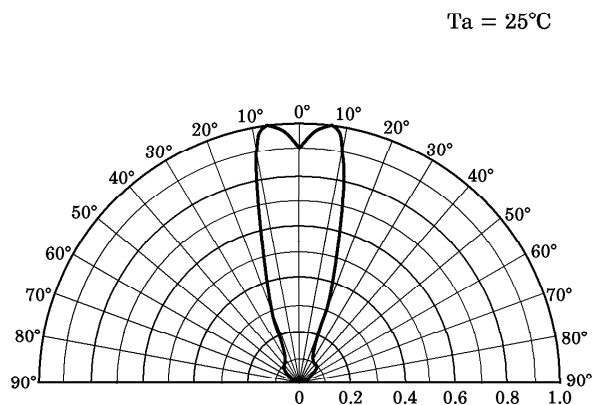

TLGD1005A

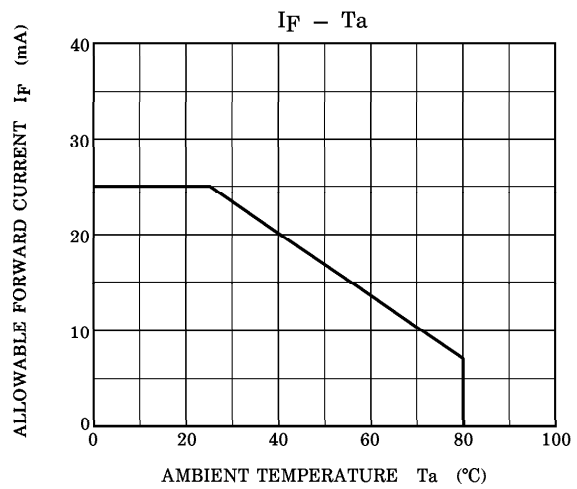
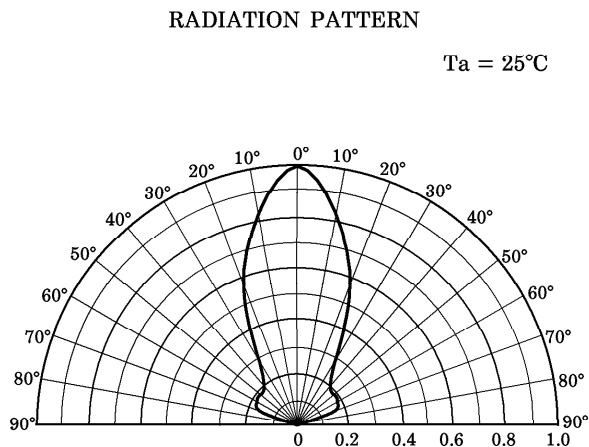
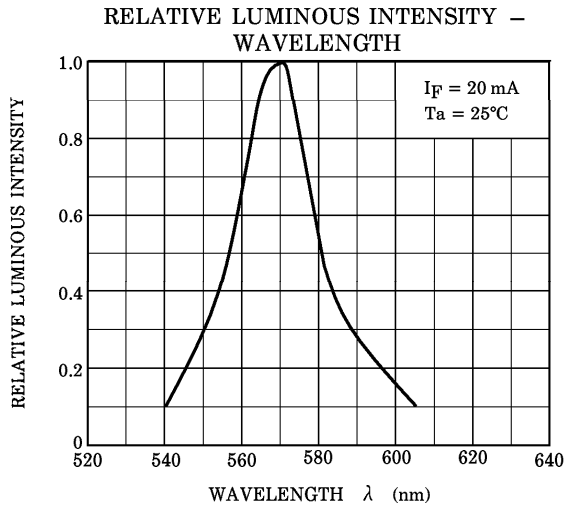
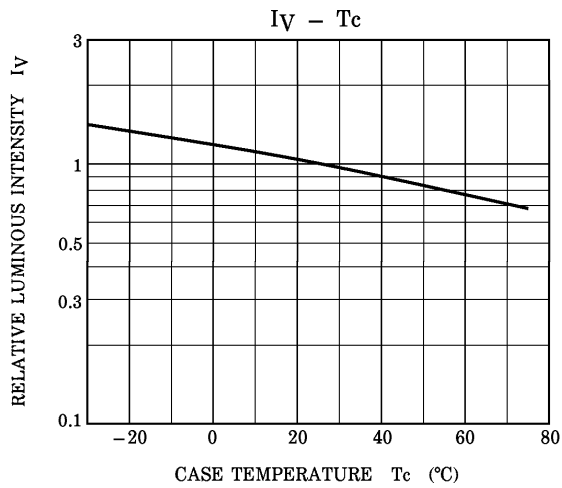
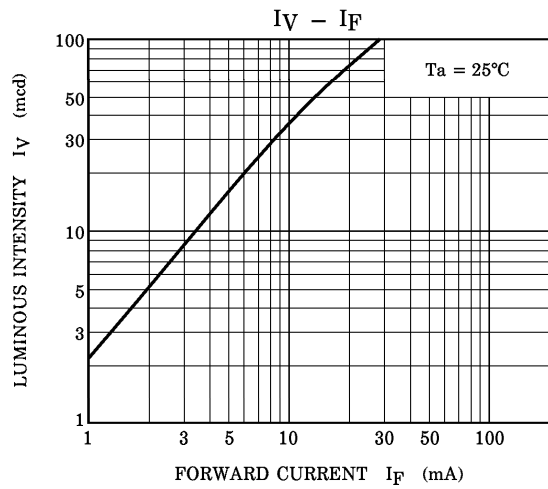
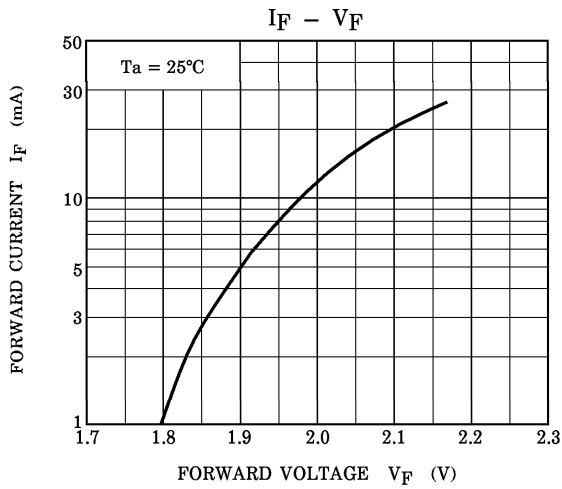

PACKAGING

This LED device is packed in an aluminum envelope with silica gel to avoid moisture absorption. The optical characteristics may be affected by exposure to moisture in the air prior to soldering and it should be stored under the following conditions.

- Temperature : 5~30°C
- Relative Humidity : 60% or lower

Baking is required if the device have been stored unopened for more than 6 months or if the aluminum envelope has been opened for more than 168 h.

Recommended baking condition is 60°C for 12 h minimum in the dry atmosphere.

PRECAUTION FOR MOUNTING

- Do not apply force to the plastic part of the LED in high temperature conditions.
- Do not apply friction using a hard materials for avoid injuring the plastic part of the LED.
- Keep the LED away from any other parts when assembling boards into the set.

SOLDERING

- Reflow soldering

Temperature profile

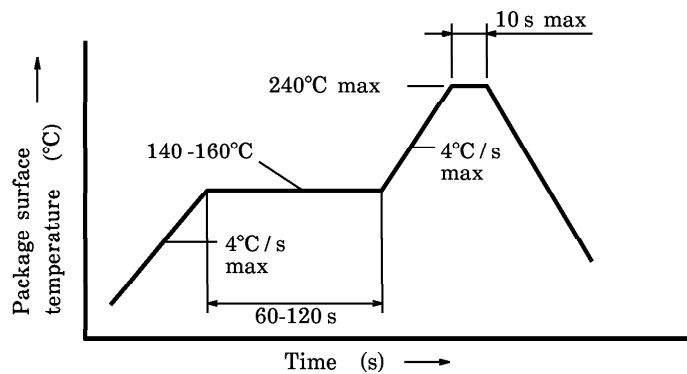

- Second time reflow soldering

In case of second reflow soldering, it should be performed within 168 h after first reflow under the above conditions.

Storage conditions before second reflow soldering : 30°C, 60% RH or lower

- Do not perform flow soldering.
- Make any necessary soldering corrections manually.
(Do not do this more than once for any given pin.)

- Soldering iron : Less than 25 W
- Temperature : Lower than 300°C
- Time : Within 3 s

- Recommended soldering pattern

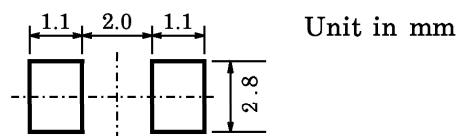

POST SOLDER CLEANING

When cleaning after soldering is needed, the following condition must be adhered to.

- Cleaning solvents : AK225 or Alcohol
- Temperature : 50°C (max) for 30 s (max) or 30°C (max) for 3 minutes (max)
- Ultrasonic : 300 W max

AUTOMATIC MOUNTING : RECOMMENDED CONDITION

Absorption Head Diameter	φ 1.2 mm
--------------------------	----------

Please ask the mounting equipment maker for the ideal automatic mounting condition.

TAPING SPECIFICATIONS

This specification lays out the 4 mm pitch embossed-tape packing requirements for 3.2 mm (L) × 2.4 mm (W) × 2.4 mm (H) size surface-mount LED lamp.

1. Product Naming System

The type of package used for shipment is denoted by a symbol suffix after the product number. The method of classification is as below. (this method, however does not apply to products whose electrical characteristics differ from standard Toshiba specifications)

(1) Tape Type : T03 (4 mm pitch)

(2) Example

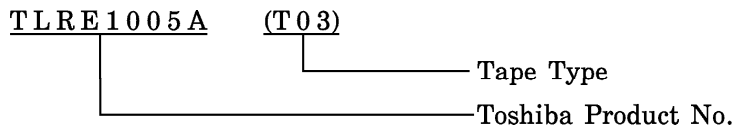

2. Related Matter

(1) Electro-optical Characteristics

Please refer to the each technical datasheet for electro-optical characteristics of tape packed products

(2) Handling Precautions

Tape material protected against static electricity. However, static electricity may occur depending on quantity of charged static electricity and a device may attach to a tape, or a device may be unstable when peeling a tape cover.

- a) In process, taping materials may sustain an electrostatic charge, use an ionizer to neutralize the ions.
- b) For transport and temporary storage of devices, use containers (boxes, jigs, bags) that are made of anti-static materials or of materials that dissipate electrostatic electricity.

3. Dimensions of tape

(Unit in mm)

SYMBOL	DIMENSION	TOLERANCE	SYMBOL	DIMENSION	TOLERANCE
D	1.50	+0.1 / -0	P ₂	2.00	±0.05
E	1.75	±0.1	W	8.00	±0.3
P ₀	4.00	±0.1	P	4.00	±0.1
t	0.25	±0.05	A ₀	2.80	±0.1
F	3.50	±0.05	B ₀	3.50	±0.1
D ₁	1.10	±0.1	K ₀	2.70	±0.1

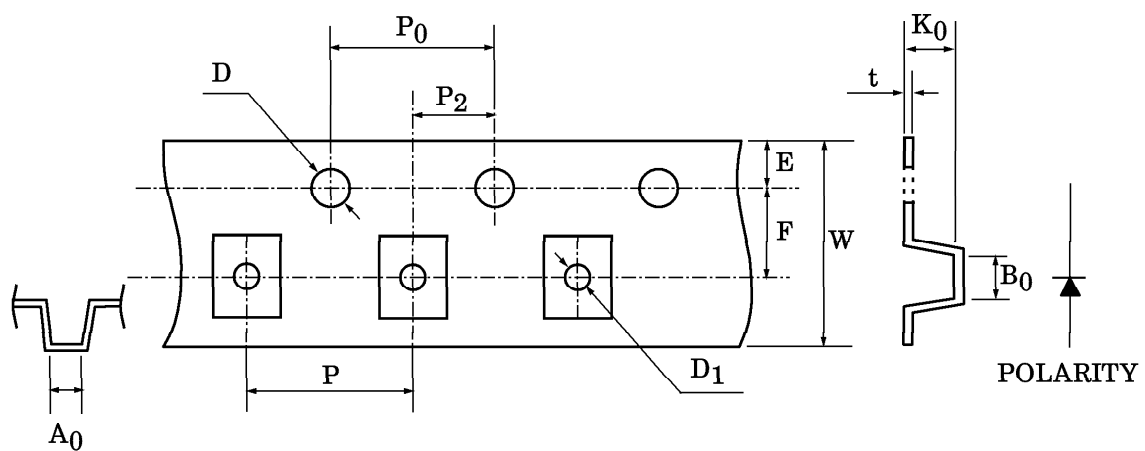

4. Dimensions of reel

Unit in mm

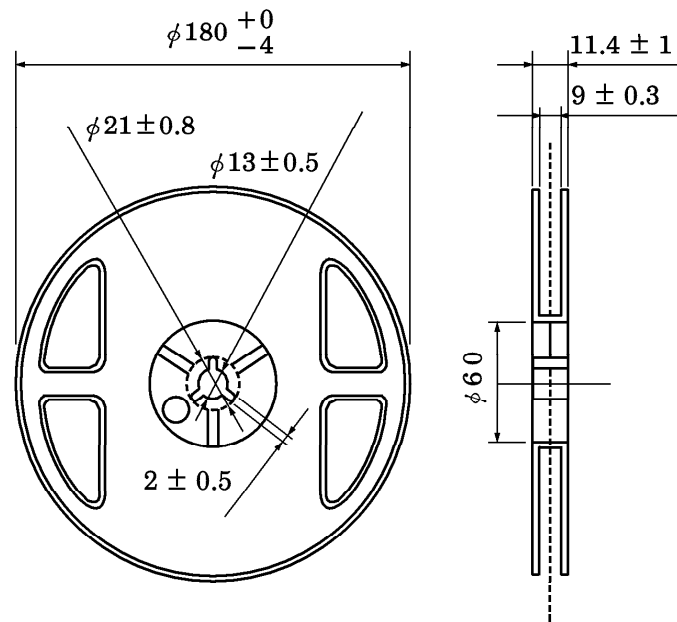

5. Leading part

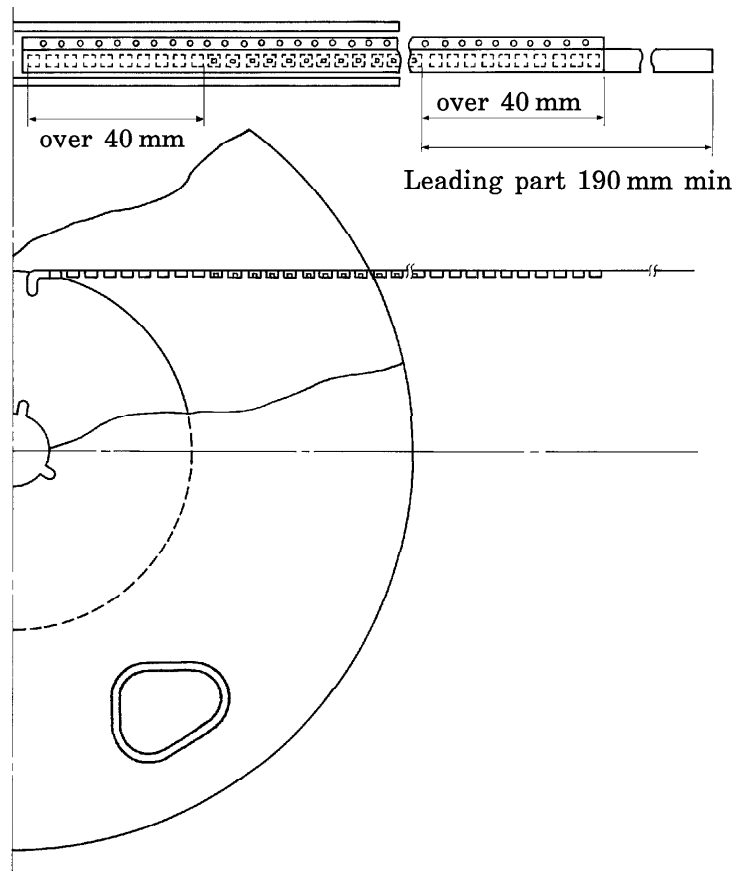

6. Packing Form

(1) Number of Devices per Reel and Carton

Reel	1000 devices
Carton	5000 devices

(2) Packing : Silica gel and reel are packed into sealed aluminum pack.

7. Notation Method

(1) Example : TLRE1005A (T03)

P/N :

TYPE	TLRE1005A		
ADD. C	(T03)	Q'TY	1000 pcs
NOTE	(rank symbol)		Lot Number

(2) Label location :

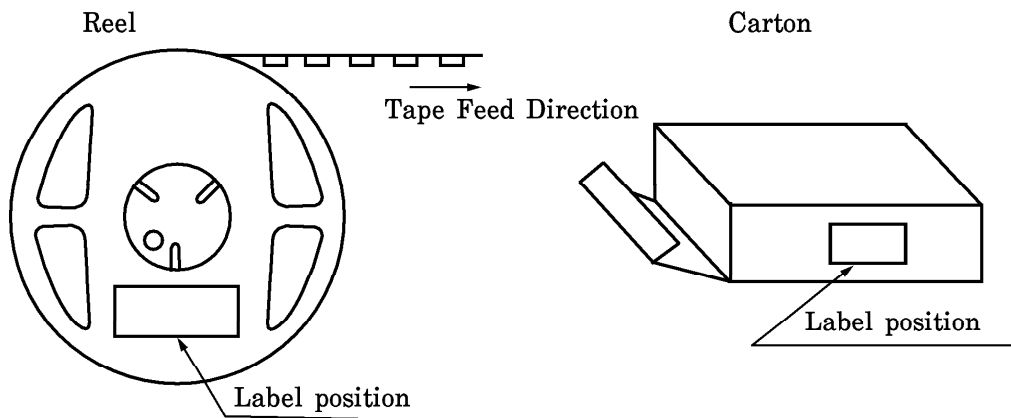

Aluminum pack : Attached to center of one side

RESTRICTIONS ON PRODUCT USE

000707EAC

- TOSHIBA is continually working to improve the quality and reliability of its products. Nevertheless, semiconductor devices in general can malfunction or fail due to their inherent electrical sensitivity and vulnerability to physical stress. It is the responsibility of the buyer, when utilizing TOSHIBA products, to comply with the standards of safety in making a safe design for the entire system, and to avoid situations in which a malfunction or failure of such TOSHIBA products could cause loss of human life, bodily injury or damage to property. In developing your designs, please ensure that TOSHIBA products are used within specified operating ranges as set forth in the most recent TOSHIBA products specifications. Also, please keep in mind the precautions and conditions set forth in the "Handling Guide for Semiconductor Devices," or "TOSHIBA Semiconductor Reliability Handbook" etc..
- The TOSHIBA products listed in this document are intended for usage in general electronics applications (computer, personal equipment, office equipment, measuring equipment, industrial robotics, domestic appliances, etc.). These TOSHIBA products are neither intended nor warranted for usage in equipment that requires extraordinarily high quality and/or reliability or a malfunction or failure of which may cause loss of human life or bodily injury ("Unintended Usage"). Unintended Usage include atomic energy control instruments, airplane or spaceship instruments, transportation instruments, traffic signal instruments, combustion control instruments, medical instruments, all types of safety devices, etc.. Unintended Usage of TOSHIBA products listed in this document shall be made at the customer's own risk.
- Gallium arsenide (GaAs) is a substance used in the products described in this document. GaAs dust and fumes are toxic. Do not break, cut or pulverize the product, or use chemicals to dissolve them. When disposing of the products, follow the appropriate regulations. Do not dispose of the products with other industrial waste or with domestic garbage.
- The information contained herein is presented only as a guide for the applications of our products. No responsibility is assumed by TOSHIBA CORPORATION for any infringements of intellectual property or other rights of the third parties which may result from its use. No license is granted by implication or otherwise under any intellectual property or other rights of TOSHIBA CORPORATION or others.
- The information contained herein is subject to change without notice.