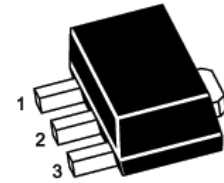

PNP Silicon Epitaxial Planar Transistor

Medium Power Transistor

 1.Base 2.Collector 3.Emitter
SOT-89 Plastic Package

Absolute Maximum Ratings ($T_a = 25\text{ }^\circ\text{C}$)

Parameter	Symbol	Value	Unit
Collector Base Voltage	$-V_{CBO}$	60	V
Collector Emitter Voltage	$-V_{CEO}$	60	V
Emitter Base Voltage	$-V_{EBO}$	6	V
Collector Current - DC	$-I_C$	2	A
Collector Current - Pulse ¹⁾	$-I_{CP}$	6	A
Total Power Dissipation	P_{tot}	0.5 2 ²⁾	W
Junction Temperature	T_J	150	$^\circ\text{C}$
Storage Temperature Range	T_{Stg}	- 55 to + 150	$^\circ\text{C}$

¹⁾ Single pulse, PW = 10 ms ²⁾ When mounted on a 40 X 40 X 0.7 mm cermic board

Characteristics at $T_a = 25\text{ }^\circ\text{C}$

Parameter	Symbol	Min.	Typ.	Max.	Unit
DC Current Gain					
at $-V_{CE} = 2\text{ V}$, $-I_C = 0.5\text{ A}$	h_{FE}	120	-	270	-
at $-V_{CE} = 2\text{ V}$, $-I_C = 1.5\text{ A}$	h_{FE}	45	-	-	-
Collector Base Breakdown Voltage					
at $-I_C = 50\text{ }\mu\text{A}$	$-V_{(BR)CBO}$	60	-	-	V
Collector Emitter Breakdown Voltage					
at $-I_C = 1\text{ mA}$	$-V_{(BR)CEO}$	60	-	-	V
Emitter Base Breakdown Voltage					
at $-I_E = 50\text{ }\mu\text{A}$	$-V_{(BR)EBO}$	6	-	-	V
Collector Base Cutoff Current					
at $-V_{CB} = 50\text{ V}$	$-I_{CBO}$	-	-	0.1	μA
Emitter Base Cutoff Current					
at $-V_{EB} = 5\text{ V}$	$-I_{EBO}$	-	-	0.1	μA
Collector Emitter Saturation Voltage					
at $-I_C = 1\text{ A}$, $-I_B = 50\text{ mA}$	$-V_{CE(sat)}$	-	-	0.35	V
Transition Frequency					
at $-V_{CE} = 2\text{ V}$, $-I_E = 0.5\text{ A}$, $f = 100\text{ MHz}$	f_T	-	200	-	MHz
Output Capacitance					
at $-V_{CB} = 10\text{ V}$, $f = 1\text{ MHz}$	C_{ob}	-	23	-	pF

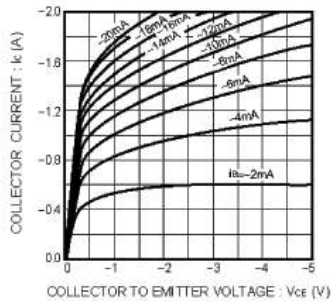

Fig.1 Grounded emitter output characteristics

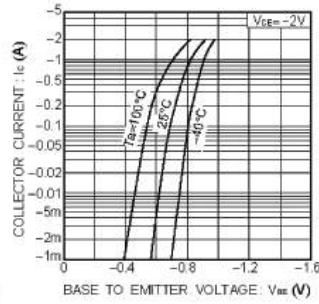

Fig.2 Grounded emitter propagation characteristics

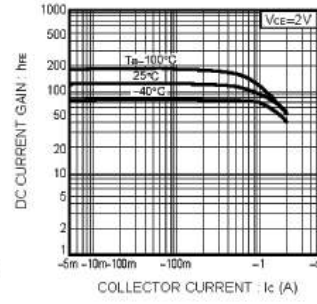

Fig.3 DC current gain vs. collector current (I)

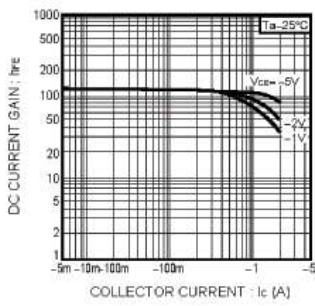

Fig.4 DC current gain vs. collector current (II)

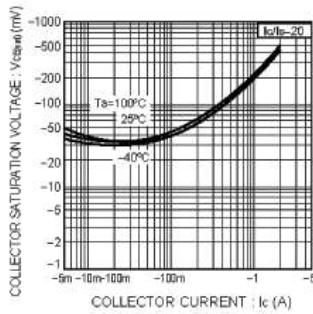

Fig.5 Collector-emitter saturation voltage vs. collector current (I)

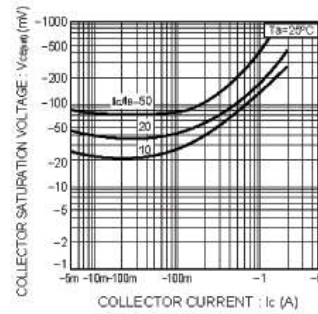

Fig.6 Collector-emitter saturation voltage vs. collector current (II)

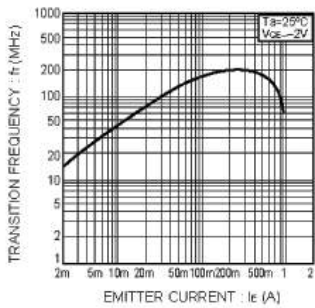

Fig.7 Gain bandwidth product vs. emitter current

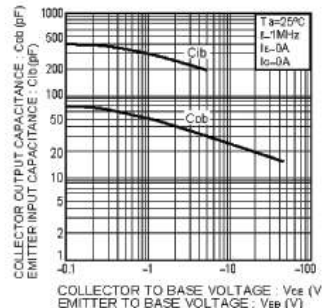

Fig.8 Collector output capacitance vs. collector-base voltage
Emitter input capacitance vs. emitter-base voltage

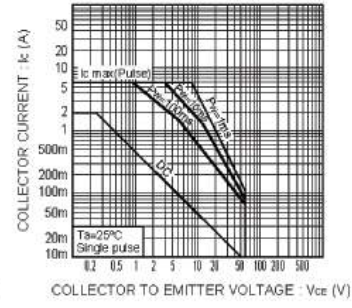
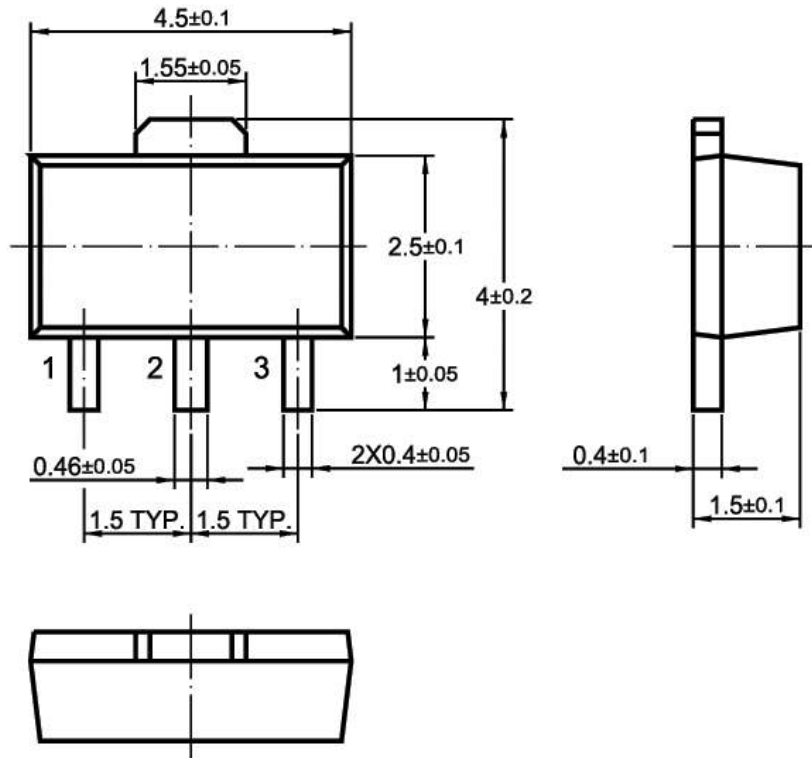

Fig.9 Safe operating area

SOT-89 PACKAGE OUTLINE



Dimensions in mm