

Dual Input 1.6A Linear Charger with 28V OVP in a 3x4 TDFN Package

General Description

The AAT3692 BatteryManager™ is an integrated single cell Lithium-Ion (Li-Ion) battery charger IC, designed to operate from USB ports, AC adapter inputs, or from a cellular phone charger adapter up to an input voltage of 7.2V typical. For increased safety, the AAT3692 also includes over-voltage input protection (OVP) up to 28V.

The AAT3692 precisely regulates battery charge voltage and current for 4.2V Li-Ion battery cells. The charge current can be programmed up to 1.6A for ADP charging and 0.5A for USB charging by external resistors on the ADPSET/USBSET pins; the percentage of the termination charging current is programmable by an external resistor on the R_{TERM} pin. In the case of an over-voltage condition of ADP or USB input power exceeding typical 7.2V, the internal series switch opens, blocking the damage to the battery and charging circuitry.

The AAT3692 also includes a no-battery present input (NOBAT). When NOBAT indicates that no battery is present, the charging function will be suspended while OVP is still active.

Battery charging status is continuously monitored for fault conditions. In the event of a battery over-voltage or chip over thermal failure, the charger will automatically suspend charging, protecting the charging device, control system and battery, until the fault condition is removed. An open drain POK pin indicates the valid input of AC adapter or USB power; an open drain status monitor output pin (STAT) is adopted to report battery charging activity by active low.

The AAT3692 comes in a thermally enhanced, space-saving, Pb-free 16-pin 3x4 mm TDFN package and is specified for operation over the -40°C to +85°C temperature range.

Typical Application

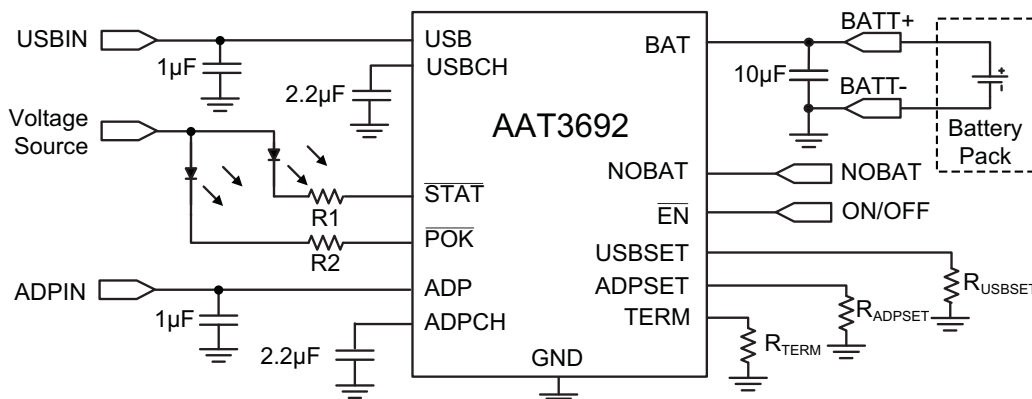

Features

- Dual Input USB and AC Adapter Input
 - Programmable Constant Current from 100mA to 1.6A for ADP Charge
 - Programmable Constant Current from 50mA to 0.5A for USB Charge
- No Battery Present Input Detection
- 3.0V ~ 7.2V (typical) Input Voltage Range
- Over-Voltage Input Protection up to 28V
- High Level of Integration with Internal:
 - Power Device
 - Reverse Current Blocking
 - Current Sensing
- Automatic Recharge Sequencing
- Automatic Charge Reduction
- Programmable Charge Termination Current Percentage
- Fast Over-Voltage Protection Turn Off and Release Turn On Time
- Full Battery Charge Auto Turn Off/Sleep Mode/Charge Termination
- Charge Status Indicator
- Input Power Good Indicator
- Automatic Trickle Charge for Battery Preconditioning
- Thermal Shutdown Protection
- Active Digital Thermal Loop Control
- Power On Reset and Soft Start
- Active Low Enable with Internal 200kΩ Resistor Pull-Down to GND
- 3x4mm TDFN Package

Applications

- Digital Still Cameras
- Mobile Phones
- Personal Data Assistants (PDAs)
- Other Li-Ion Battery Powered Devices

Dual Input 1.6A Linear Charger with 28V OVP in a 3x4 TDFN Package**Pin Descriptions**

Pin #	Name	Type	Function
1	USB	I	Input from USB port connector
2	USBCH	I/O	Output from USB OVP stage, input to battery charger. Decouple with 2.2μF capacitor.
3	ADP	I	Input from adapter port connector
4	ADPCH	I/O	Output from ADP OVP stage, input to battery charger. Decouple with 2.2μF capacitor.
5	POK	O	Input power status Indication pin, open drain. A 10kΩ pull-up resistor is recommended.
6	STAT	O	Charge status indication pin, open drain.
7	TERM	I	Termination current percentage programming input pin. Typical 13.3kΩ for 10% termination current of fast charging current.
8, 9	GND		Connect to power ground
10	IC	I	Internally used. Connect to GND or leave floating.
11	EN	I	Active low enable with internal 200kΩ resistor pull-down to GND.
12	ADPSET	I	ADP charge current programming input pin.
13	USBSET	I	USB charge current programming input pin.
14	NOBAT	I	No battery present input. Logic "High" indicates no battery. Internal 1.6MΩ pull-high resistor.
15	N/C		No connection.
16	BAT	O	Connect to lithium-ion battery.

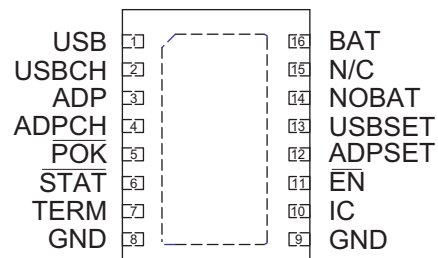
Pin Configuration**TDFN34-16
(Top View)**

Dual Input 1.6A Linear Charger with 28V OVP in a 3x4 TDFN Package**Absolute Maximum Ratings¹**

Symbol	Description	Value	Units
V_{ADP}, V_{USB}	ADP, USB input continuous	28	V
V_{ADPCH}, V_{USBCH}	Charger input continuous	-0.3 to 7.5	V
V_N	BAT, \overline{STAT} , \overline{EN} , ADPSET, USBSET, NOBAT, IC. TERM, \overline{POK}	-0.3 to 7.5 + 0.3	V
T_J	Operating Junction Temperature Range	-40 to 150	°C
T_{LEAD}	Maximum Soldering Temperature (at Leads)	300	°C

Thermal Information²

Symbol	Description	Value	Units
Θ_{JA}	Maximum Thermal Resistance (TDFN 3x4)	50	°C/W
P_D	Maximum Power Dissipation	2	W

1. Stresses above those listed in Absolute Maximum Ratings may cause permanent damage to the device. Functional operation at conditions other than the operating conditions specified is not implied. Only one Absolute Maximum Rating should be applied at any one time.
2. Mounted on a FR4 board.

DATA SHEET

AAT3692

Dual Input 1.6A Linear Charger with 28V OVP in a 3x4 TDFN Package

Electrical Characteristics¹

$V_{ADP} = V_{USB} = 5V$, $T_A = -25^{\circ}C$ to $+85^{\circ}C$, unless otherwise noted. Typical values are at $T_A = 25^{\circ}C$.

Symbol	Description	Conditions	Min	Typ	Max	Units
Operation						
V_{ADP_MAX} , V_{USB_MAX}	Input Over-Voltage Protection Range				28	V
V_{ADP} , V_{USB}	ADP and USB Normal Operating Input Voltage Range		3.0		7.05	V
I_{ADP_OP} , I_{USB_OP}	Operating Current	V_{ADP} or $V_{USB} = 5V$, Charge current = 100mA, $\overline{EN} = 0V$		0.5	1.5	mA
$I_{SD(OFF)}$	Shutdown Supply Current	V_{ADP} or $V_{USB} = 5V$, $\overline{EN} = 5V$		8		μA
$I_{STANDBY}$	Standby Mode Current	Charge Terminated		300		μA
I_{BAT}	Leakage Current from BAT Pin	$V_{BAT} = 4V$, USB and ADP open		1	4	μA
Over-Voltage Protection						
V_{OVPT}	Over-Voltage Protection Trip Voltage	Rising edge	7.05	7.2	7.5	V
	Hysteresis			300		mV
Battery Charger						
V_{UVLO_ADP} , V_{UVLO_USB}	Under-Voltage Lockout Threshold	Rising edge			3.0	V
	UVLO Hysteresis			150		mV
Voltage Regulation						
V_{BAT_EOC}	Output Charge Voltage Regulation		4.158	4.20	4.242	V
$\Delta V_{CH}/V_{CH}$	Output Charge Voltage Tolerance			0.5		%
V_{MIN}	Preconditioning Voltage Threshold		2.4	2.6	2.8	V
V_{RCH}	Battery Recharge Voltage Threshold			$V_{BAT_EOC} - 0.1$		V
Battery Charging Device						
$R_{DS(ON)}$	Charging and OVP Total ON Resistance	V_{ADP} or $V_{USB} = 5V$, $T_A = 25^{\circ}C$			600	m Ω
Current Regulation						
I_{LIM_ADP}	ADP Charge Current Programmable Range		100		1600	mA
I_{LIM_USB}	USB Charge Current Programmable Range		50		500	mA
I_{CH_CC}	Constant-Current Mode Charge Current	$V_{BAT} = 3.6V$	-10		10	%
V_{ADPSET} , V_{USBSET}	ADPSET, USBSET Pin Voltage			2		V
V_{TERM}	TERM Pin Voltage	$R_{TERM} = 13.3k\Omega$		0.2		V
KI_{ADPSET}	Charge Current Set Factor: I_{CH_CC}/I_{ADPSET}	Constant current mode, $V_{BAT} = 3.6V$		800		
KI_{USBSET}	Charge Current Set Factor: I_{CH_CC}/I_{USBSET}	Constant current mode, $V_{BAT} = 3.6V$		800		
I_{CH_TRK}/I_{CH_CC}	Trickle Charge Current Percentage	$R_{ADPSET} = 8k\Omega$	5	10	15	%
I_{CH_TERM}/I_{CH_CC}	Charge Termination Threshold Current Percentage	$I_{CH_CC} \geq 800mA$, $R_{TERM} = 13.3k\Omega$	8	10	12	%

1. The AAT3692 is guaranteed to meet performance specifications over the $-40^{\circ}C$ to $+85^{\circ}C$ operating temperature range and are assured by design, characterization and correlation with statistical process controls.

DATA SHEET

AAT3692

Dual Input 1.6A Linear Charger with 28V OVP in a 3x4 TDFN Package

Electrical Characteristics (continued)¹

$V_{ADP} = V_{USB} = 5V$, $T_A = -25^{\circ}C$ to $+85^{\circ}C$, unless otherwise noted. Typical values are at $T_A = 25^{\circ}C$.

Symbol	Description	Conditions	Min	Typ	Max	Units
Logic Control / Battery Protection						
$V_{EN\#(H)}$	Input High Threshold	$V_{ADP} = 5V$	1.2			V
$V_{EN\#(L)}$	Input Low Threshold				0.4	V
V_{STAT}	Output Low Voltage	STAT pin sinks 4mA			0.4	V
I_{STAT}	STAT Pin Current Sink Capability			4	8	mA
V_{POK}	POK Output Low Voltage	POK pin sinks 4mA			0.4	V
I_{POK}	Current Sink Capability			4	8	mA
$V_{NOBAT(H)}$	No Battery Present Input High Threshold		1.2			V
$V_{NOBAT(L)}$	No Battery Present Input Low Threshold				0.4	V
V_{BOVP}	Battery Over-Voltage Protection Threshold			4.4		V
T_{RESPOV}	Over-Voltage Response Time	V_{ADP} , V_{USB} voltage step up signal from 6V to 8V		0.5	1.0	μs
T_{OVPON}	OVP Switch OVP Release Turn-On Delay Time	V_{ADP} voltage step down signal from 8V to 6V, $R_{LOAD} = 10\Omega$, $C_{ADPCH} = 1\mu F$		5		μs
$T_{OVSTARTON}$	OVP Switch Start Up Turn-On Delay Time	V_{ADP} voltage step up signal from 0V to 5V, $R_{LOAD} = 10\Omega$, $C_{ADPCH} = 1\mu F$		130		μs
T_{OVPR}	OVP Switch Turn-On Rise Time	$R_{LOAD} = 10\Omega$, $C_{ADPCH} = 1\mu F$		100		μs
T_{SHDN}	Chip Thermal Shutdown Temperature	Thermal Shutdown Threshold		140		$^{\circ}C$
		Hysteresis		15		

1. The AAT3692 is guaranteed to meet performance specifications over the $-40^{\circ}C$ to $+85^{\circ}C$ operating temperature range and are assured by design, characterization and correlation with statistical process controls.

Dual Input 1.6A Linear Charger with 28V OVP in a 3x4 TDFN Package

Typical Characteristics

Over-Voltage Protection Trip Voltage vs. Temperature

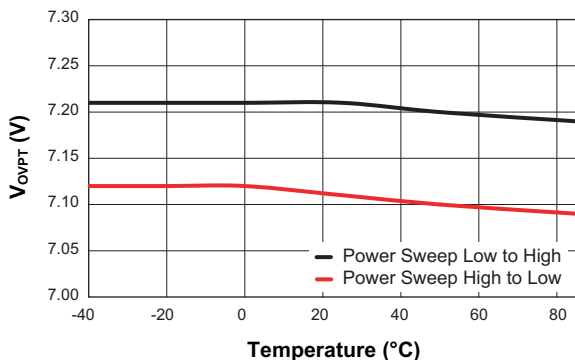

End of Charge Voltage vs. Input Voltage
(R_{ADPSET} = 1kΩ, R_{USBSET} = 3.2kΩ)

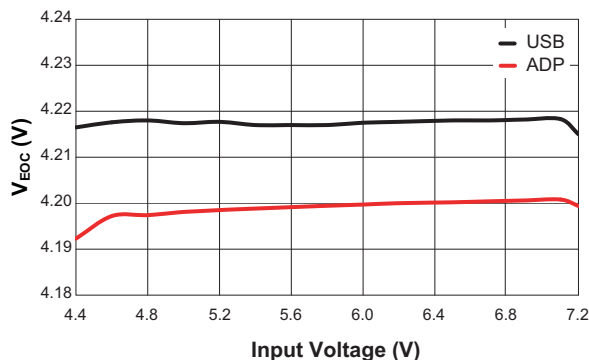

I_{CHARGE} vs. R_{ADPSET}

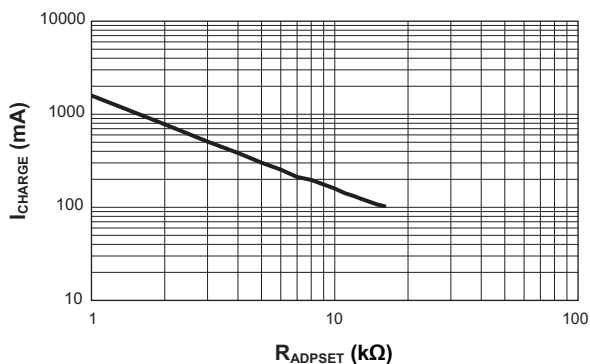

I_{CHARGE} vs. R_{USBSET}

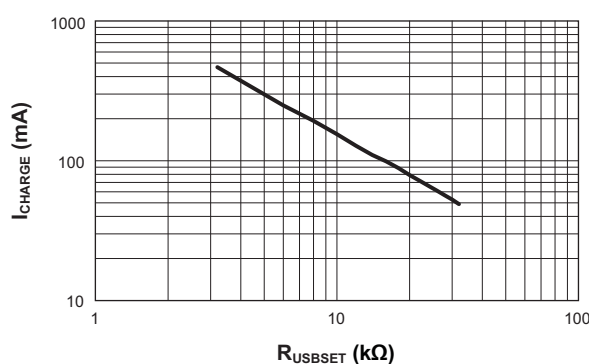

Battery Recharge Voltage Threshold vs. Input Voltage

(R_{ADPSET} = 1kΩ; R_{USBSET} = 3.2kΩ; C_{BAT} = 22μF)

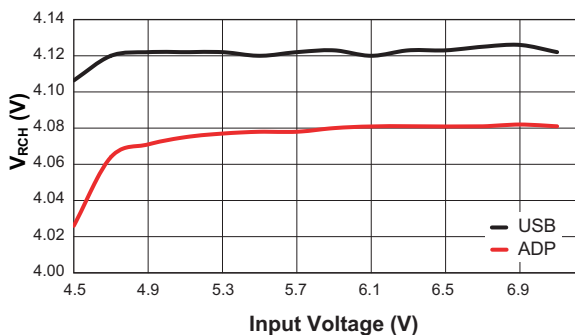

Battery Recharge Voltage Threshold vs. Temperature

(V_{ADP} = V_{USB} = 5V; R_{ADPSET} = 1kΩ; R_{USBSET} = 3.2kΩ; C_{BAT} = 22μF)

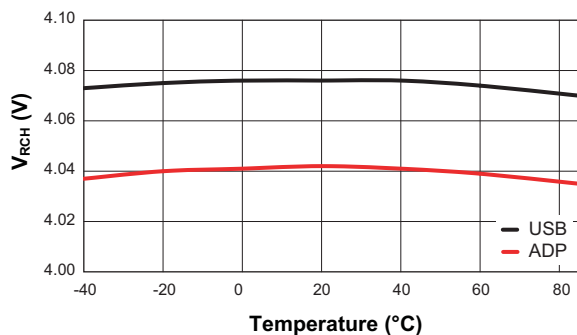

AAT3692

Dual Input 1.6A Linear Charger with 28V OVP in a 3x4 TDFN Package

Typical Characteristics

End of Charge Voltage vs. Temperature
($R_{ADPSET} = 1k\Omega$; $R_{USBSET} = 3.2k\Omega$)

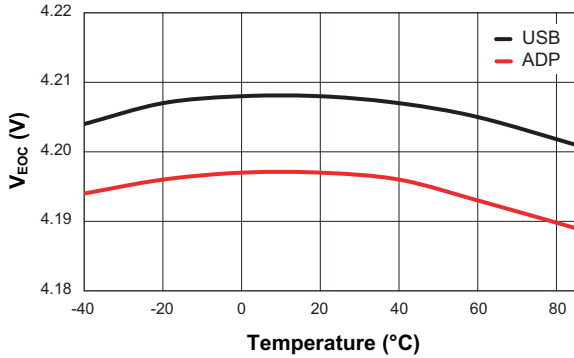

Charge Current vs. Temperature

($V_{ADP} = V_{USB} = 5V$; $V_{BAT} = 3.6V$;
 $R_{ADPSET} = 1k\Omega$; $R_{USBSET} = 3.2k\Omega$)

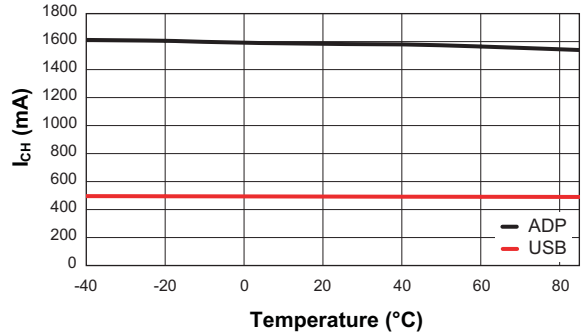

Charging Current vs. Battery Voltage
($V_{ADP} = V_{USB} = 5V$; $R_{ADPSET} = 1k\Omega$; $R_{USBSET} = 3.2k\Omega$)

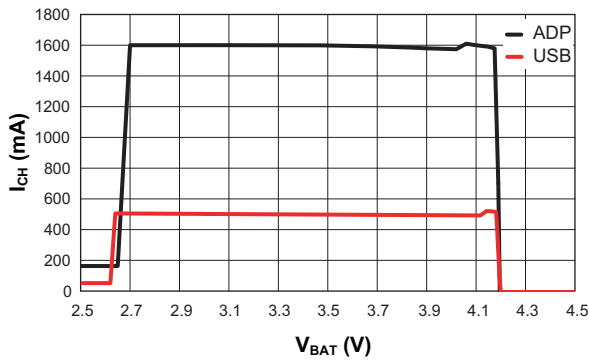

USB Charging Current vs. Input Voltage
($R_{USBSET} = 3.2k\Omega$)

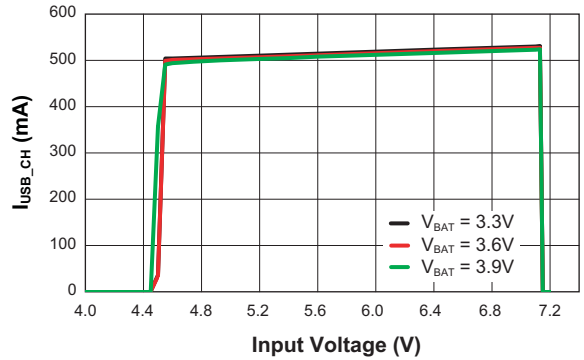

ADP Charging Current vs. Input Voltage
($R_{ADPSET} = 1k\Omega$)

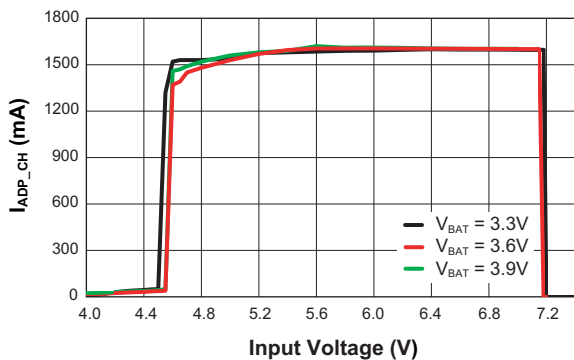

USB Charging Current vs. Input Voltage
($R_{USBSET} = 3.2k\Omega$)

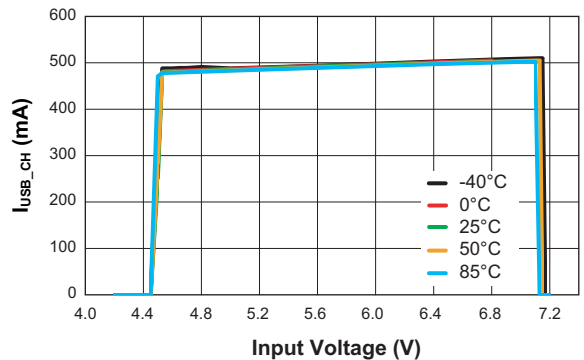

Dual Input 1.6A Linear Charger with 28V OVP in a 3x4 TDFN Package

Typical Characteristics

ADP Charging Current vs. Battery Voltage
($V_{ADP} = 5V$)

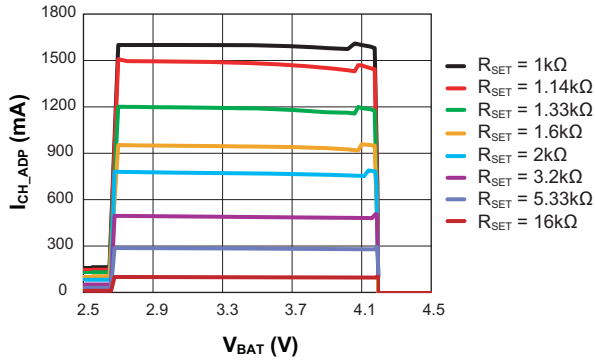

USB Charging Current vs. Battery Voltage
($V_{USB} = 5V$)

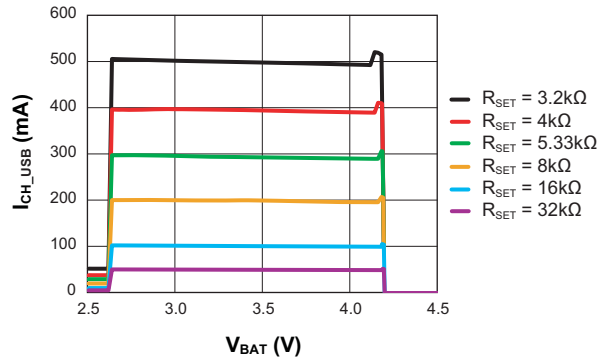

NOBAT V_{IH} vs. Input Voltage

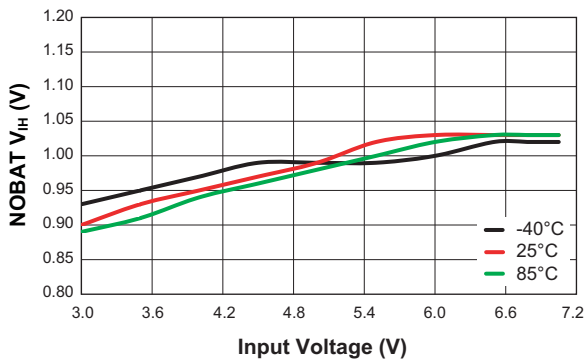

NOBAT V_{IL} vs. Input Voltage

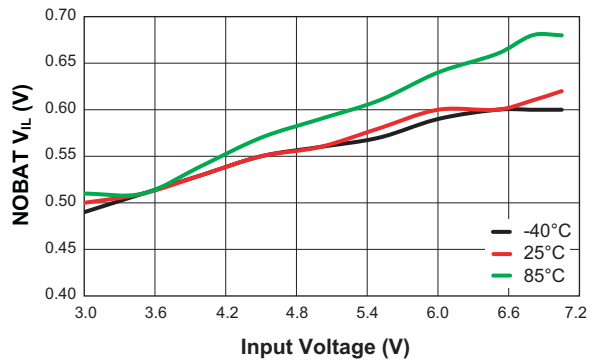

EN V_{IH} vs. Input Voltage

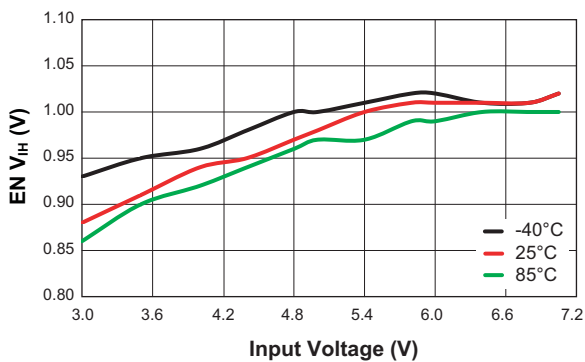

EN V_{IL} vs. Input Voltage

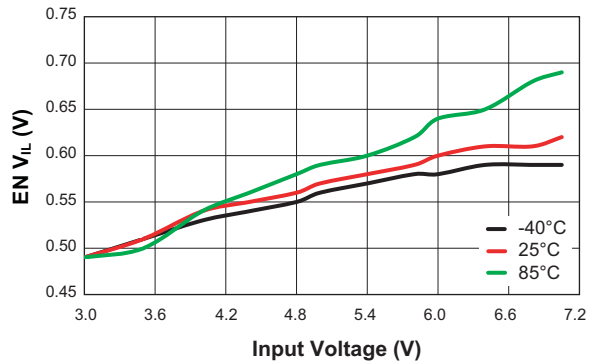

AAT3692

Dual Input 1.6A Linear Charger with 28V OVP in a 3x4 TDFN Package

Typical Characteristics

Over-Voltage Response Time
 ($V_{ADP}/V_{USB} = 6.0V$ to $8.0V$, $R_{LOAD} = 2k\Omega$)

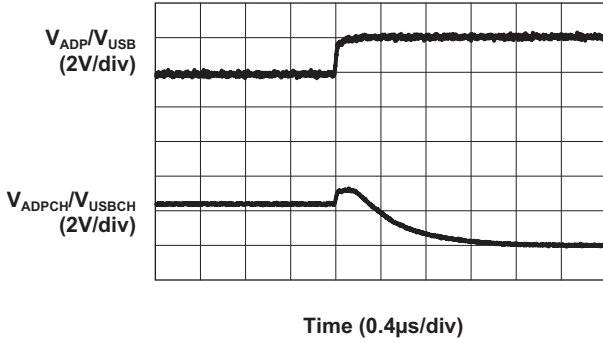

OVP Switch Start-up Time
 ($V_{ADP} = 0V$ to $5.0V$, $R_{LOAD} = 2k\Omega$)

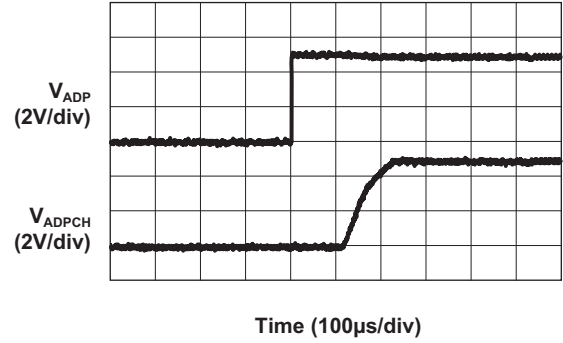

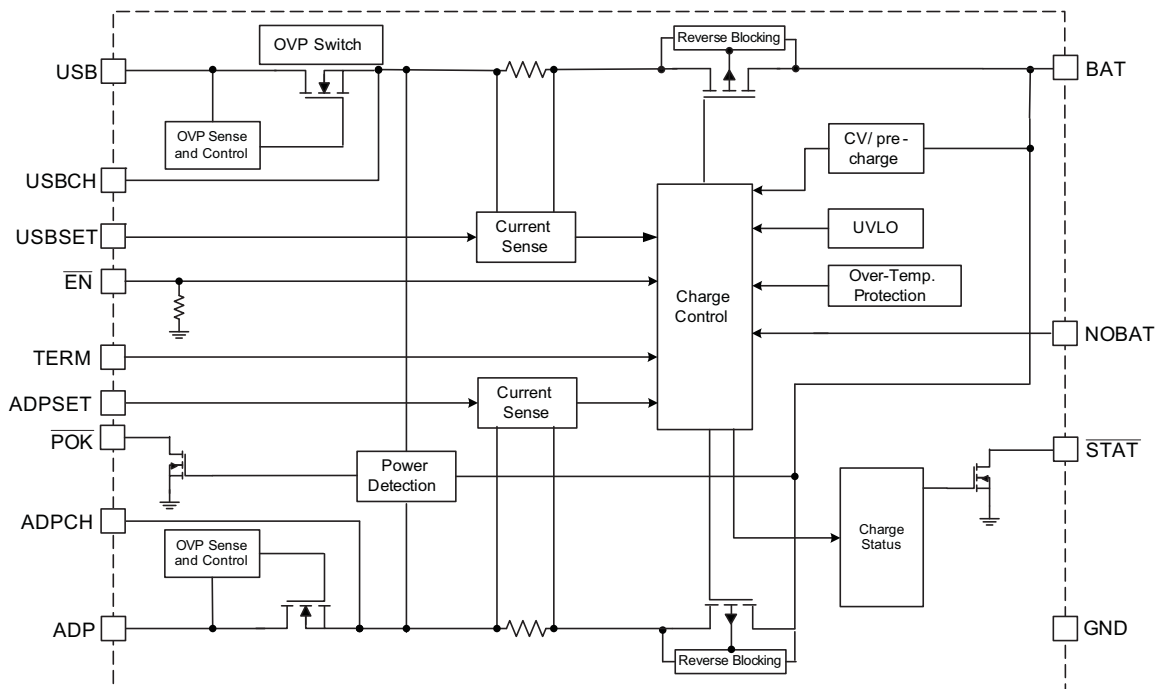
Dual Input 1.6A Linear Charger with 28V OVP in a 3x4 TDFN Package**Functional Block Diagram****Functional Description**

The AAT3692 is a high performance battery charger designed to charge single cell lithium-ion or polymer batteries with up to 1600mA charging current from an adapter (ADP) power source, or with up to 500mA charging current from an USB power source. The AAT3692 is a stand-alone charging solution, with just a few external components required for complete functionality. Both input paths include a fast turn-off over-voltage protection (OVP) circuit with voltage up to +28V and an under-voltage lockout level of 3.0V.

The AAT3692 automatically selects the charging source from USB or ADP according to ADP and USB voltage. The ADP path is always the high priority charging path when ADP voltage is higher than 4.5V. The charging current is determined by the selected charging path and its external set resistor (R_{SET}).

USB charging uses an automatic charge reduction loop control to allow battery charging with limited available current from a USB port while maintaining the regulated port voltage. This system assures that the battery charge function will not overload a USB port while charging if other system demands also share power with the respective port supply.

During adapter charging, high set charging current or high ambient operating temperature may cause the AAT3692 junction temperature to rise up to 110°C. A special digital thermal loop control system is employed to maximize charging current by dynamically decreasing the battery charging current.

Thermal protection suspends the AAT3692's charging function when internal dissipation becomes excessive, while the OVP function remains available. The junction over-temperature threshold is 140°C with 15°C of hysteresis. Once an over-temperature condition is removed, the charging function automatically recovers.

The status monitor output pin (\overline{STAT}) is designed to indicate the battery charge status with open-drain structure by directly driving one external LED. The power OK output pin (POK) is targeted as a system power valid indication signal for charging.

Battery Charging Operation

Regardless of which charge input function is selected (adapter input or USB input), the AAT3692 has three basic modes for the battery charge cycle: preconditioning (trickle) charge, constant current/fast charge, and constant voltage charge. When no automatic charge

Dual Input 1.6A Linear Charger with 28V OVP in a 3x4 TDFN Package

reduction mode or digital thermal loop is triggered, the charge profile is controlled as shown in Figure 1.

Battery charging commences only after the AAT3692 checks several conditions in order to maintain a safe charging environment. The input supply must be above the minimum operating voltage and the enable pin must be low. When the battery is connected to the BAT pin and the NOBAT pin indicates there is a battery connected, the AAT3692 checks the condition of the battery and determines which charging mode to apply. If the battery voltage is below V_{MIN} , then the device begins trickle charging by charging at 10% of the programmed constant current. For example, if the programmed current is 500mA, then the trickle charge current is 50mA. Trickle charging is a safety precaution for a deeply discharged cell and will also reduce the power dissipation in the internal series pass MOSFET when the input-output voltage differential is at its highest. Trickle charging continues until the battery voltage reaches V_{MIN} . At this point, the AAT3692 begins constant current charging. The current value for this mode is programmed by the external resistors from the ADPSET and USBSET pin to ground. Programmed current can be set from a minimum of 100mA up to a maximum of 1.6A for an ADP power source, and from a minimum of 50mA up to a maximum of 500mA for a USB power source. Constant current charging continues until the battery voltage reaches the voltage regulation point, V_{BAT_EOC} . When the battery voltage reaches V_{BAT_EOC} (typical 4.2V), the AAT3692 will switch to constant voltage mode. In this mode, charge current decreases until it is reduced to a certain percentage of the current programmed by the resistor between

TERM and ground. After the charge cycle is complete, the AAT3692 turns off the series pass device and automatically goes into standby mode. During this time, the series pass device will block current in both directions, therefore preventing the battery from discharging through the IC.

The AAT3692 remains in standby mode until either the battery terminal voltage drops below the V_{RCH} threshold, the charger \overline{EN} pin is recycled, or the charging source is reconnected. In all cases, the AAT3692 will monitor all parameters and resume charging in the most appropriate mode.

Over-Voltage Protection

In normal operation an OVP switch acts as a slew-rate controlled load switch, connecting and disconnecting the power supply from ADP to ADPCH and USB to USBCH. A low-resistance MOSFET is used to minimize the voltage drop between the voltage source and the charger and to reduce the power dissipation. When the voltage on the input exceeds the 7.2V (typical) voltage limit, the device immediately turns off the internal OVP switch, disconnecting the load from the abnormal voltage and preventing damage to any downstream components.

On initial power-up with low and battery present, if $V_{USB/ADP} < V_{UVLO}$ (3V maximum), the OVP switch is held off; if $V_{UVLO} < V_{USB/ADP} < 7.2V$ (typical), the OVP switch will turn on after a 130 μ s typical internal delay; if $V_{USB/ADP}$ rises above 7.2V (typical), the OVP switch is turned off after a 0.5 μ s typical internal delay.

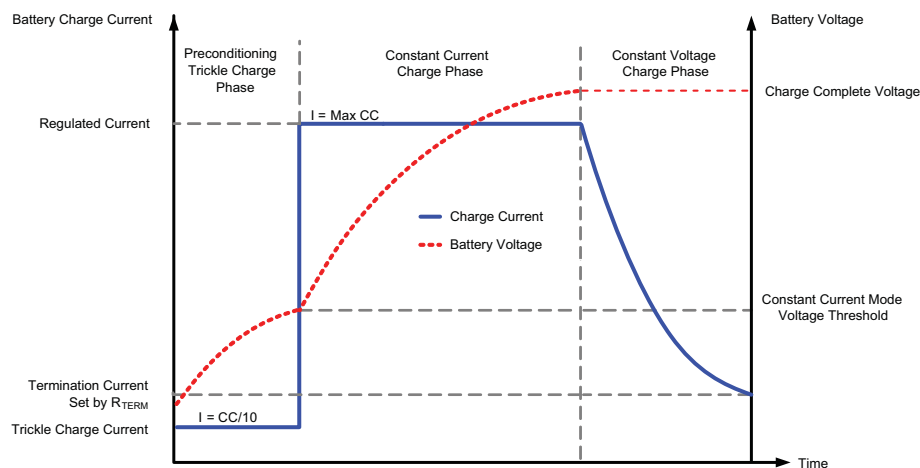
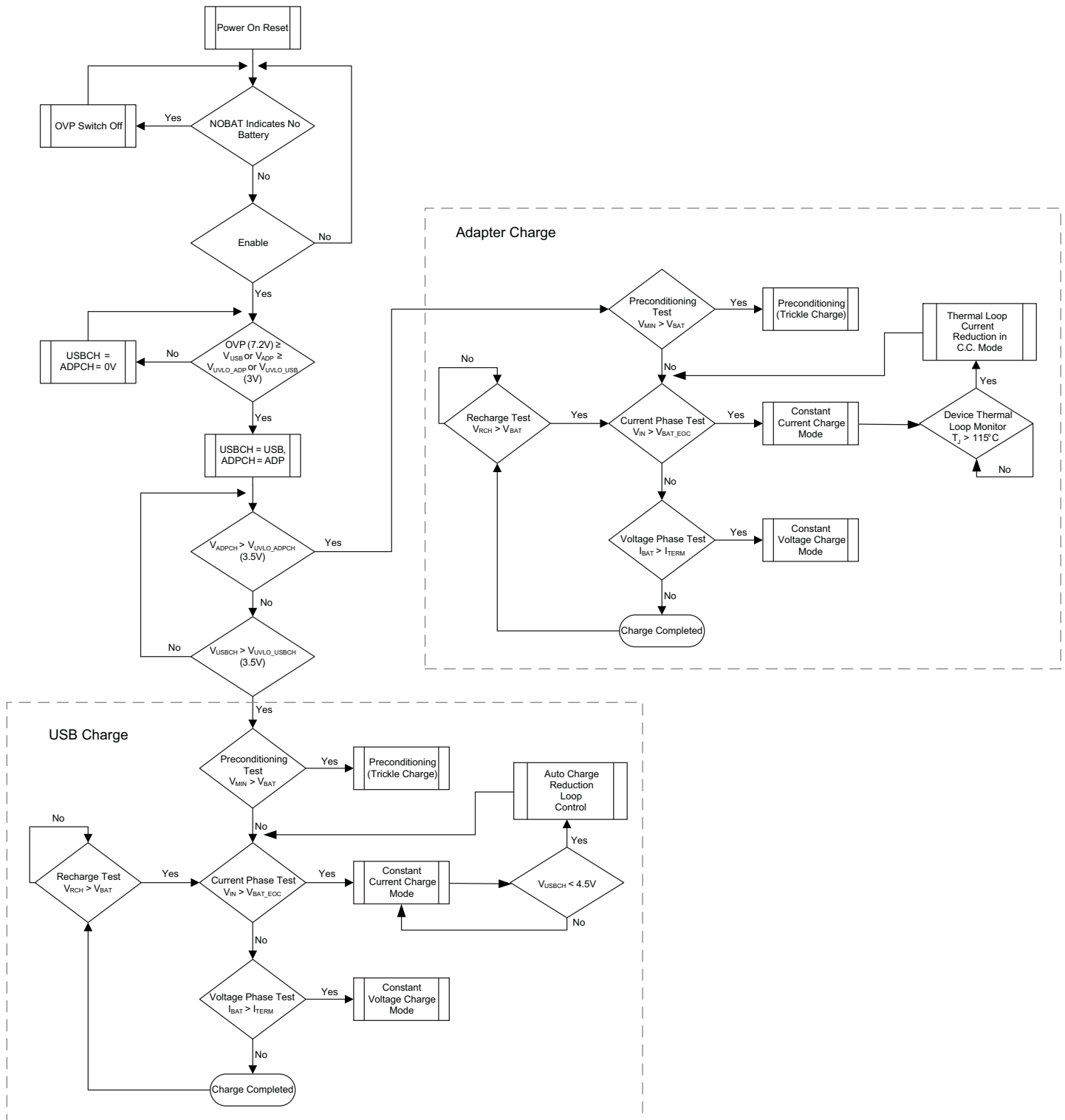

Figure 1: Charge Current vs. Battery Voltage Profile during Charging Phases.

Dual Input 1.6A Linear Charger with 28V OVP in a 3x4 TDFN Package

System Operation Flowchart



Dual Input 1.6A Linear Charger with 28V OVP in a 3x4 TDFN Package

Application Information

Charge Sources

The AAT3692 operates from sources of an adapter or USB interface. The internal system control will always select the adapter input to charge the battery rather than the USB input if the adapter voltage is above 4.5V. The normal charging input voltage range is up to typical 7.2V. The device can withstand up to 28V on the adapter or USB inputs without damage to the IC. If V_{ADP} or V_{USB} is greater than 7.2V, the internal over-voltage protection circuitry suspends charging until the input falls below typical 7.0V.

AC Adapter/USB System Power Charging

Adapter Mode

In the adapter mode, constant current charge levels up to 1.6A can be programmed by the user. The fast charge current for the adapter input mode is set by the R_{ADPSET} resistor connected between ADPSET and ground. It is programmed by the following equations:

$$I_{ADP_CC} = \frac{2}{R_{ADPSET}} \cdot KI_{ADPSET}$$

$$R_{ADPSET} = \frac{2}{I_{ADP_CC}} \cdot KI_{ADPSET}$$

with $KI_{ADPSET} = 800$. Table 1 gives the recommended 1% tolerance metal film resistance values for a desired constant current charge level.

Thermal Loop Control

To protect the linear charging IC from thermal problems, a special thermal loop control system is used to maximize charging current under adapter charge mode. The thermal management system measures the internal circuit die temperature and reduces the fast charge current when the die exceeds the preset internal temperature control threshold. Once the thermal loop control becomes active, the fast charge current is initially reduced by a factor of 0.44.

The initial thermal loop current can be estimated by the following equation:

$$I_{TLOOP} = I_{CC} \cdot 0.44$$

I_{CH_CC} (mA)	R_{ADPSET} (k Ω)	R_{USBSET} (k Ω)
50		32.4
75		21.5
100	16	16
200	8.06	8.06
300	5.36	5.36
400	4.02	4.02
500	3.24	3.24
600	2.67	
700	2.32	
800	2	
900	1.78	
1000	1.60	
1100	1.47	
1200	1.33	
1300	1.24	
1400	1.15	
1500	1.07	
1600	1	

Table 1: Standard 1% Metal Film Resistor Values for Constant Current Setting.

The thermal loop control re-evaluates the circuit die temperature every three seconds and raises the fast charge current in small steps to the full fast charge current level. Figure 2 illustrates the thermal loop function at 1A fast charge current as the ambient temperature increases and recovers. In this manner the thermal loop controls the system charge level, and the AAT3692 provides the highest level of constant current in the fast charge mode for any possible valid ambient temperature condition.

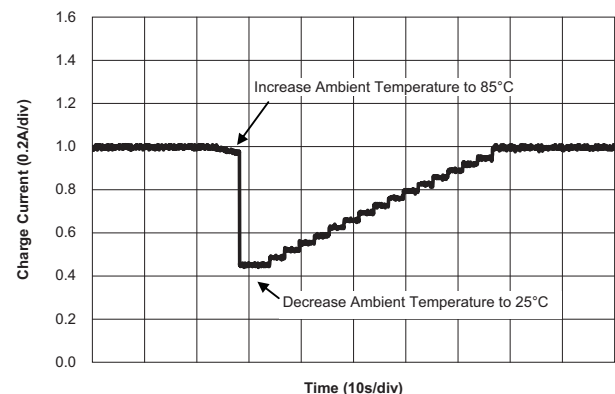

Figure 2: Digital Thermal Loop Function at 1A Fast Charge Current with Ambient Temperature Increasing and Recovering.

Dual Input 1.6A Linear Charger with 28V OVP in a 3x4 TDFN Package**Adapter Input Charge Inhibit and Resume**

The AAT3692 has an under-voltage lockout feature so that if the charger input supply ADP pin drops below the UVLO threshold, the charger will suspend charging. When the UVLO condition is removed and $V_{ADPCH} > V_{BATr}$, the system charge control assesses the state of charge of the battery cell and automatically resumes charging in the appropriate phase (pre-conditioning trickle charge, constant current charge, constant voltage charge or end of charge) according to the condition of the battery.

USB Mode

The AAT3692 also provides an input for intelligent USB charging. When no voltage is present on the adapter input pin or adapter input is below 4.5V, the charge controller will automatically switch to accepting power from the USB input. The USB charge may be user programmed to any level between 50mA and 500mA by selecting the appropriate resistor values for R_{USBSET} .

$$I_{USB_CC} = \frac{2}{R_{USBSET}} \cdot KI_{USBSET}$$

$$R_{USBSET} = \frac{2}{I_{USB_CC}} \cdot KI_{USBSET}$$

Among them, KI_{USBSET} is 800. Refer to Table 1 for recommended R_{USBSET} values for the desired USB input constant current charge levels.

USB Charge Reduction

In many instances, product system designers do not know the real properties of a potential USB port used to supply power to the battery charger. Typically, powered USB ports found on desktop and notebook PCs should supply up to 500mA. If a USB port being used to supply the charger is unable to provide the programmed fast charge current or if the system under charge must share supply current with other functions, the AAT3692 automatically reduces USB fast charge current to maintain port integrity and protect the host system.

The USB charge reduction system becomes active when the voltage on the USBCH input falls below the USB charge reduction threshold, typically 4.5V. The charge reduction system reduces the fast charge current level in a linear fashion until the voltage sensed on the USB input recovers above the charge reduction threshold voltage.

USB Input Charge Inhibit and Resume

The AAT3692 UVLO and power on reset feature functions when the USB input pin voltage level drops below the UVLO threshold. At this point, the charger suspends charging and shuts down. When power is re-applied to the USB pin or the UVLO condition recovers, the system charge control will assess the state of charge on the battery cell and automatically resume charging in the appropriate mode for the condition of the battery.

Programmable Charge Termination Current Percentage

The charge termination current percentage of fast charge current can be programmed by an external resistor from TERM to GND. The resistance can be calculated by

$$R_{TERM} = 133 \cdot \frac{I_{CH_TERM}}{I_{CH_CC}} \cdot 10^3$$

Among them, I_{CH_CC} is the fast charge current of valid source; e.g., if the design target of charge termination current is 100mA for 1A ADP fast charge current, then

$$R_{TERM} = 133 \cdot \frac{100mA}{1A} \cdot 10^3 = 13.3k\Omega$$

At this R_{TERM} setting, when USB is the active charging source, charge termination current percentage is still 10% of the USB fast charge current. So if the USB fast charge current is 500mA, the charge termination current is 50mA.

Table 2 shows some standard metal resistor values for different charge termination current percentages.

Charge Termination Current Percentage (%)	R_{TERM} (k Ω)
10	13.3
15	20
20	26.7
25	34
30	41.2
35	47.5
40	53.6
45	60.4
50	66.5

Table 2: Standard 1% Metal Film Resistor Values for Charge Termination Current Percentage Settings.

Dual Input 1.6A Linear Charger with 28V OVP in a 3x4 TDFN Package**Enable / Disable**

The AAT3692 provides an enable function to allow the normal operating input voltage to pass through and control the IC charging. The Enable (EN) pin is active low and is pulled down to ground by an internal 200kΩ resistor. When pulled to a logic high level, the AAT3692 is shut down and forced into the sleep state during which input voltage up to 28V will be blocked and charging be halted regardless of the battery voltage or charging state. When the device is re-enabled, the OVP block will automatically reassess the input voltage and allow the normal operating voltage to pass through. If a battery is also present (NOBAT is low), the charge control circuit will automatically reset and resume charging with the appropriate charging mode based on the battery charge state and measured cell voltage.

Battery Charge and Power OK Status Indications

The AAT3692 has two open drain outputs, $\overline{\text{STAT}}$ and $\overline{\text{POK}}$, for battery charge status and power OK indications. The battery charger status LED can indicate simple functions such as battery charging, charge complete, and charge disabled.

Description	EN	LED Status
Battery charging	low	on
Charge complete	low	off
Charge disabled	high	off

Table 3: STAT LED Indications.

$\overline{\text{POK}}$ is an open drain output to indicate valid power for charging. The valid power source range for charging is not only related to the normal operating range, but also to the battery voltage. If the input power source is higher than the UVLO threshold, lower than the OVP threshold, and greater than typical 220mV of V_{BAT} , $\overline{\text{POK}}$ will be pulled down.

The LED anodes should be connected to either V_{USBCH} or V_{ADPCH} , depending upon system design requirements. The LEDs should be biased with as little current as necessary to create reasonable illumination; therefore, a ballast resistor should be adopted to limit the current flowing through the LED by connecting it with the LED in series between $\overline{\text{STAT}}$ and V_{USBCH} or V_{ADPCH} . LED current consumption will add to the overall thermal power budget for the device package, so LED drive current should be kept to a minimum. 2mA should be sufficient to drive most low-cost green or red LEDs. It is not recommended

to exceed 8mA for driving an individual status LED. The required ballast resistor value can be estimated using the following formulas:

To connect to ADPCH:

$$R = \frac{V_{\text{ADPCH}} - V_{\text{FLED}}}{I_{\text{LED}}}$$

To connect to USBCH:

$$R = \frac{V_{\text{USBCH}} - V_{\text{FLED}}}{I_{\text{LED}}}$$

For example, using a red LED with 2.0V V_{F} @ 2mA, calculate R under 5.5V V_{ADPCH} :

$$R = \frac{5.5\text{V} - 2.0\text{V}}{2\text{mA}} = 1.75\text{k}\Omega$$

Capacitor Selection**Input Capacitor**

An input capacitor is used to filter the input voltage by placing a decoupling capacitor between the ADP, ADPCH, USB and USBCH pins and ground. An input capacitor in the range of 1μF to 10μF is recommended. If the source supply is unregulated, it may be necessary to increase the capacitance to keep the input voltage above the under-voltage lockout threshold during device enable and when battery charging is initiated. This input capacitor range is also suitable for a system with an external power supply source, such as a typical AC-to-DC wall adapter. It will minimize switching or power bounce effects when the power supply is "hot plugged". Likewise, a 2.2μF or greater input capacitor is recommended for the USB input to help buffer the effects of USB source power switching, noise, and input cable impedance.

Output Capacitor

The AAT3692 requires a 1μF ceramic capacitor on the BAT pin to maintain circuit stability. This value should be increased to 10μF or more if the battery connection is made any distance from the charger output. In a fast charge application with current above 1A, a 22μF output capacitor is required to obtain an accurate recharge voltage threshold. If the AAT3692 is used in applications where the battery can be removed from the charger, such as in the case of desktop charging cradles, an output capacitor value greater than 10μF may be required to prevent the device from cycling on and off when no battery is present.

Dual Input 1.6A Linear Charger with 28V OVP in a 3x4 TDFN Package**Thermal Considerations**

The actual maximum charging current is a function of the charge input voltage (USBCH and ADPCH), the battery voltage at the BAT pin, the ambient temperature, the rising temperature when charge current passing through the $R_{DS(ON)}$ of the charging pass, and the thermal impedance of the package. The maximum programmable current may not be achievable under all operating parameters.

The AAT3692 is offered in a 3x4mm TDFN package which can provide up to 2.0W of power dissipation when properly soldered to a printed circuit board and has a maximum thermal resistance of 50°C/W. Many considerations should be taken into account when designing the printed circuit board layout, as well as the placement of the charger IC package in proximity to other heat generating devices in a given application design. The ambient temperature around the charger IC will also have an effect on the thermal limits of a battery charging application. The maximum limits that can be expected for a given ambient condition can be estimated by the following discussion:

First, the maximum power dissipation for a given situation should be calculated:

$$P_D = [(V_{IN} - V_{BAT}) \cdot I_{CC} + (V_{IN} \cdot I_{OP})]$$

Where:

P_D = Total power dissipation of the AAT3692

V_{IN} = V_{ADP} or V_{USB} , depending on which mode is selected

V_{BAT} = Battery voltage at the BAT pin

I_{CC} = Maximum constant fast charge current programmed for the application

I_{OP} = Quiescent current consumed by the charger IC for normal operation.

Next, the maximum operating ambient temperature for a given application can be estimated based on the thermal resistance of the 3x4 TDFN package when sufficiently mounted to a PCB layout and the internal thermal loop temperature threshold.

$$T_A = T_J - (\theta_{JA} \cdot P_D)$$

Where:

T_A = Ambient temperature in °C

T_J = Maximum device junction temperature below the thermal loop threshold

P_D = Total power dissipation by the device

θ_{JA} = Package thermal resistance in °C/W.

Example:

For an application where the fast charge current for the adapter mode is set to 1A, $V_{ADP} = 5.0V$, and the worst case battery voltage is 3.6V, what is the maximum ambient temperature at which the digital thermal loop limiting will become active?

Given:

$$V_{ADP} = 5.0V$$

$$V_{BAT} = 3.6V$$

$$I_{CC} = 1A$$

$$I_{OP} = 0.25mA$$

$$T_J = 110°C$$

$$\theta_{JA} = 50°C/W$$

The device power dissipation for the stated condition can be calculated as below:

$$P_D = (5.0 - 3.6V) \cdot 1A + (5.0V \cdot 0.25mA) \approx 1.4W$$

The maximum ambient temperature is

$$T_A = 110°C - (50°C/W \cdot 1.4W) = 40°C$$

Therefore, under the stated conditions for this worst case power dissipation example, the AAT3692 will enter the digital thermal loop and lower the fast charge constant current when the ambient operating temperature rises above 40°C.

Printed Circuit Board Layout Considerations

For the best results, it is recommended to physically place the battery pack as close to the AAT3692 BAT pin as possible. To minimize voltage drops on the PCB, keep the high current carrying traces adequately wide. For maximum power dissipation of the AAT3692 TDFN package, the exposed pad should be soldered to the board ground plane to further increase local heat dissipation. A ground pad below the exposed pad is strongly recommended.

DATA SHEET

AAT3692

Dual Input 1.6A Linear Charger with 28V OVP in a 3x4 TDFN Package

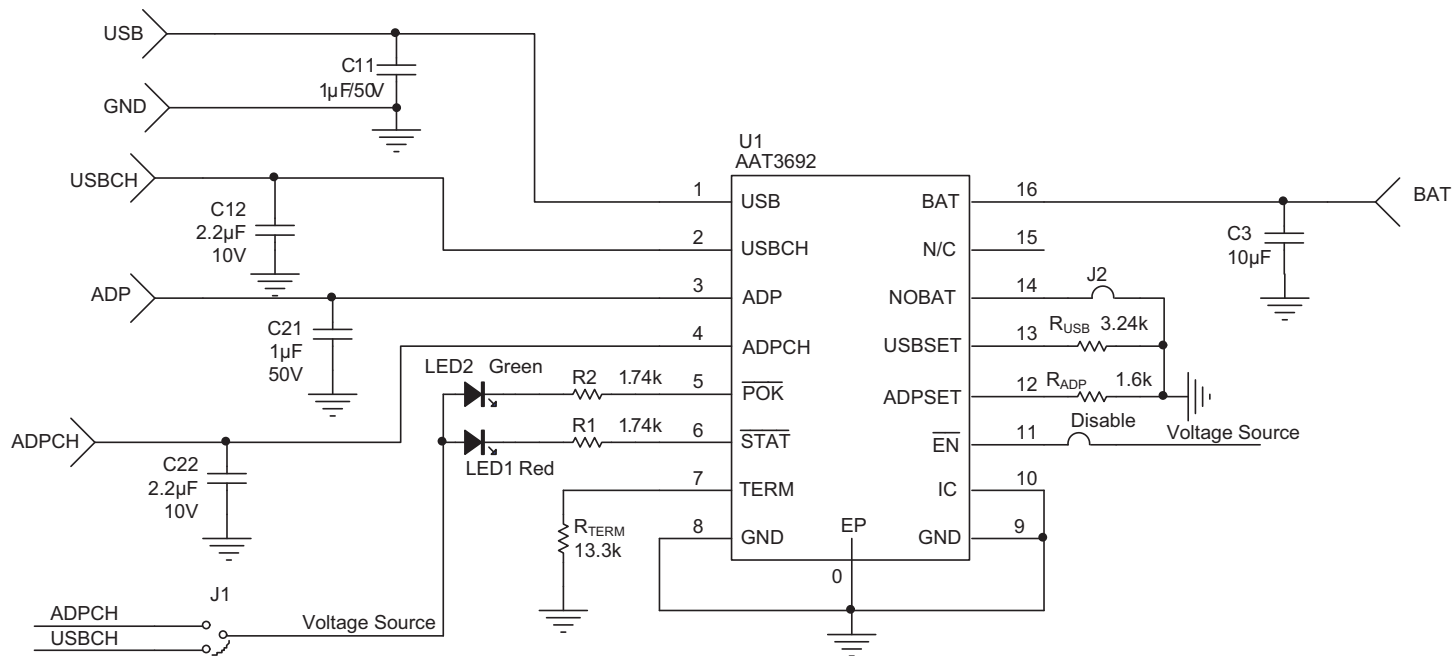

Figure 3: AAT3692 Evaluation Board Schematic.

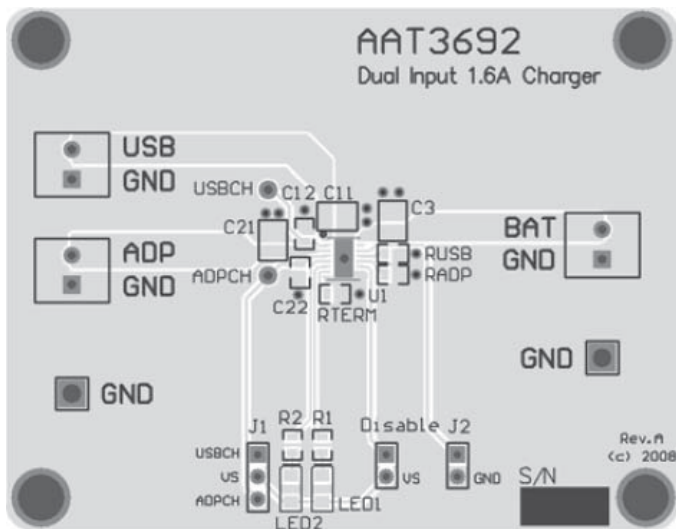

Figure 4: AAT3692 Evaluation Board Top Side Layout.

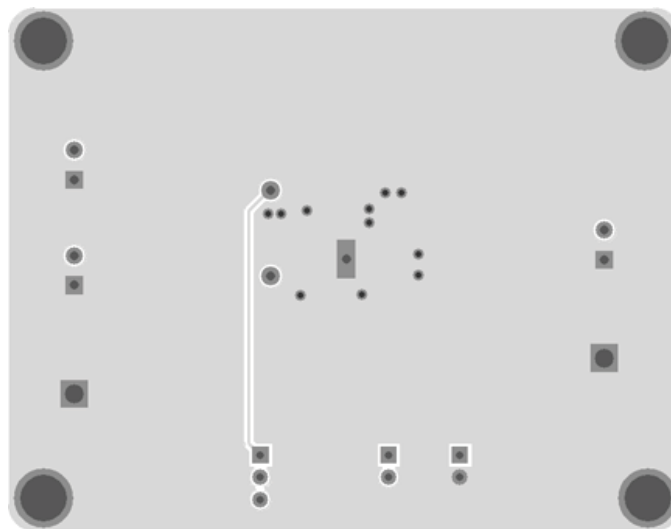

Figure 5: AAT3692 Evaluation Board Bottom Side Layout.

AAT3692**Dual Input 1.6A Linear Charger with 28V OVP in a 3x4 TDFN Package**

Component	Part Number	Description	Manufacturer
U1	AAT3692IRN	Dual Inputs 1.6A Linear Charger with 28V OVP in 16-Pin 3x4 TDFN Package	Skyworks
R1, R2	RC0603FR-071K74L	Res 1.74K Ω 1/10W 1% 0603 SMD	Yageo
RUSB	RC0603FR-071K6L	Res 1.6K Ω 1/10W 1% 0603 SMD	Yageo
RADP	RC0603FR-073K24L	Res 3.24K Ω 1/10W 1% 0603 SMD	Yageo
RTERM	RC0603FR-0713K3L	Res 13.3K Ω 1/10W 1% 0603 SMD	Yageo
C3	GRM21BR61C106K	Cap Ceramic 10 μ F 0805 X5R 16V 10%	Murata
C11, C21	GRM21BR71H105K	Cap Ceramic 1 μ F 0805 X7R 50V 10%	Murata
C12, C22	GRM188R61A225K	Cap Ceramic 2.2 μ F 0603 X5R 10V 10%	Murata
LED1	0805KRCT	Red LED; 0805	HB
LED2	0805KGCT	Green LED; 0805	HB
ADP, USB, BAT	DG308-2.54-02-14	Multi-position micro PCB terminal blocks, 2.54mm, 2 pin, Green	Degson
GNDs	5011K-ND	Black Test point	Keystone
G1, G2	5011K-ND	Black Test point	Keystone

Table 4: AAT3692 Evaluation Board Bill of Materials.

Dual Input 1.6A Linear Charger with 28V OVP in a 3x4 TDFN Package**Ordering Information**

Package	NOBAT Input	EOC Voltage	Marking ¹	Part Number (Tape and Reel) ²
TDFN34-16	Active high	4.2	8KXYY	AAT3692IRN-4.2-T1

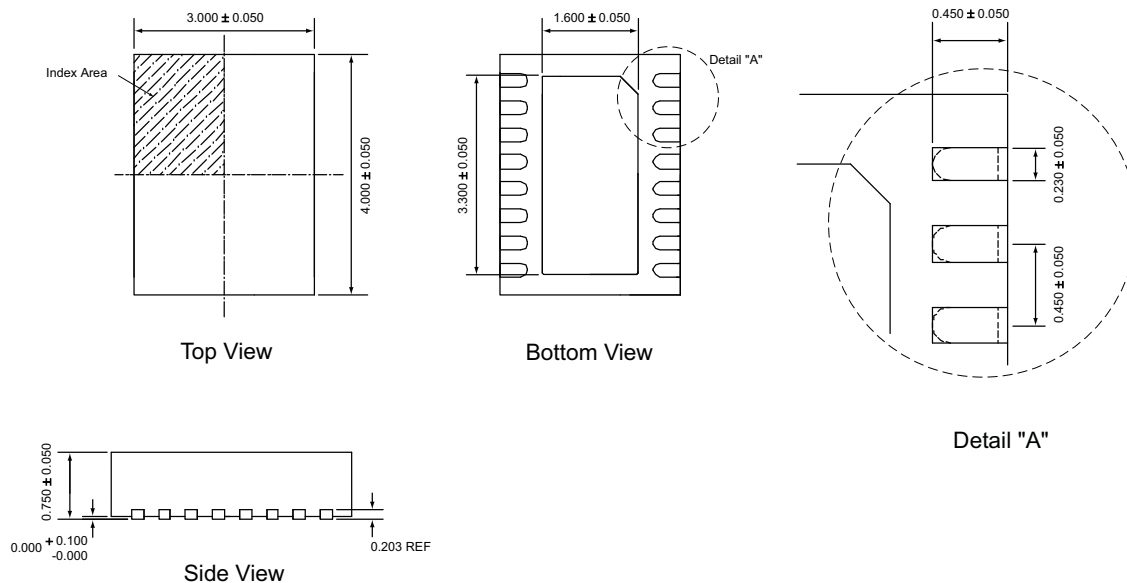

Skyworks Green™ products are compliant with all applicable legislation and are halogen-free. For additional information, refer to Skyworks Definition of Green™, document number SQ04-0074.

Package Information**TDFN34-16³**

All dimensions in millimeters.

1. XYY = assembly and date code.
2. Sample stock is generally held on part numbers listed in **BOLD**.
3. The leadless package family, which includes QFN, TQFN, DFN, TDFN and STDFN, has exposed copper (unplated) at the end of the lead terminals due to the manufacturing process. A solder fillet at the exposed copper edge cannot be guaranteed and is not required to ensure a proper bottom solder connection.

Copyright © 2012 Skyworks Solutions, Inc. All Rights Reserved.

Information in this document is provided in connection with Skyworks Solutions, Inc. ("Skyworks") products or services. These materials, including the information contained herein, are provided by Skyworks as a service to its customers and may be used for informational purposes only by the customer. Skyworks assumes no responsibility for errors or omissions in these materials or the information contained herein. Skyworks may change its documentation, products, services, specifications or product descriptions at any time, without notice. Skyworks makes no commitment to update the materials or information and shall have no responsibility whatsoever for conflicts, incompatibilities, or other difficulties arising from any future changes.

No license, whether express, implied, by estoppel or otherwise, is granted to any intellectual property rights by this document. Skyworks assumes no liability for any materials, products or information provided hereunder, including the sale, distribution, reproduction or use of Skyworks products, information or materials, except as may be provided in Skyworks Terms and Conditions of Sale.

THE MATERIALS, PRODUCTS AND INFORMATION ARE PROVIDED "AS IS" WITHOUT WARRANTY OF ANY KIND, WHETHER EXPRESS, IMPLIED, STATUTORY, OR OTHERWISE, INCLUDING FITNESS FOR A PARTICULAR PURPOSE OR USE, MERCHANTABILITY, PERFORMANCE, QUALITY OR NON-INFRINGEMENT OF ANY INTELLECTUAL PROPERTY RIGHT; ALL SUCH WARRANTIES ARE HEREBY EXPRESSLY DISCLAIMED. SKYWORKS DOES NOT WARRANT THE ACCURACY OR COMPLETENESS OF THE INFORMATION, TEXT, GRAPHICS OR OTHER ITEMS CONTAINED WITHIN THESE MATERIALS. SKYWORKS SHALL NOT BE LIABLE FOR ANY DAMAGES, INCLUDING BUT NOT LIMITED TO ANY SPECIAL, INDIRECT, INCIDENTAL, STATUTORY, OR CONSEQUENTIAL DAMAGES, INCLUDING WITHOUT LIMITATION, LOST REVENUES OR LOST PROFITS THAT MAY RESULT FROM THE USE OF THE MATERIALS OR INFORMATION, WHETHER OR NOT THE RECIPIENT OF MATERIALS HAS BEEN ADVISED OF THE POSSIBILITY OF SUCH DAMAGE.

Skyworks products are not intended for use in medical, lifesaving or life-sustaining applications, or other equipment in which the failure of the Skyworks products could lead to personal injury, death, physical or environmental damage. Skyworks customers using or selling Skyworks products for use in such applications do so at their own risk and agree to fully indemnify Skyworks for any damages resulting from such improper use or sale.

Customers are responsible for their products and applications using Skyworks products, which may deviate from published specifications as a result of design defects, errors, or operation of products outside of published parameters or design specifications. Customers should include design and operating safeguards to minimize these and other risks. Skyworks assumes no liability for applications assistance, customer product design, or damage to any equipment resulting from the use of Skyworks products outside of stated published specifications or parameters.

Skyworks, the Skyworks symbol, and "Breakthrough Simplicity" are trademarks or registered trademarks of Skyworks Solutions, Inc., in the United States and other countries. Third-party brands and names are for identification purposes only, and are the property of their respective owners. Additional information, including relevant terms and conditions, posted at www.skyworksinc.com, are incorporated by reference.