

## System Controller for Compact Disc Players

### Description

The CXP1042Q is a 4-bit single chip microcomputer based on the SPC500 series. It incorporates programs in firmware for CD operations. It can be connected directly to the CDL-500 series of LSIs for CD players, and can directly drive LCDs, in addition to other features. It can be employed in a wide range of equipment, from deck-type CD players to radio cassettes and portable systems.

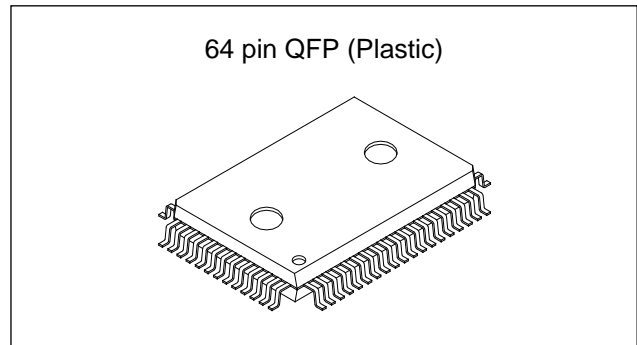

### Functions

- Key inputs of up to 16 keys is possible through matrix scanning. The following functions can be selected by setting their respective keys.
- ▶, ||, ▶|| PLAY/PAUSE/PLAY PAUSE keys
- ■ STOP key
- ◀◀, ▶▶ SKIP key; on memory input, this becomes the tune selection key
- ◀◀, ▶▶ Fast forward key; speed differs during PLAY and PAUSE
- Repeat One tune or all tunes repeat
- OPEN/CLOSE Loading function (when deck type device is selected)
- A↔B A↔B repeat function
- SHUFFLE Shuffle (random) function
- PROG Program; up to 21 tune memory, can indicate remainder
- REMAIN Indicates single tune or all tunes remaining, up to 31 tunes
- INTRO Fixes introscan at 10 seconds
- AUTO Sets auto space at 4 seconds
- MUSIC calendar Can display up to 16 tunes
- REMOTE Enables input using NEC format remote control devices with modifiable custom codes
- 10key Direct tune selection using keypad; selects tune on memory input (remote control only)
- Syncro Synchronization input and processing
- × 2 Double speed playback
- Battery detection When portable mode selected, there is battery detection function
- Simple adjustment of tracking gain/balance

### Recommended Combinations

- RF amplifier/servo signal processor CXA1782B
- Digital signal processor CXD2507A/2508A
- Pickup mechanism KSL 2101

### Structure

Silicon gate CMOS IC

Sony reserves the right to change products and specifications without prior notice. This information does not convey any license by any implication or otherwise under any patents or other right. Application circuits shown, if any, are typical examples illustrating the operation of the devices. Sony cannot assume responsibility for any problems arising out of the use of these circuits.

**Features**

- Can be connected directly to CDL-500 series LSIs for CD use
- Up to 16 keys can be connected directly; expansion of functions through addition of keys is possible

**Types of Keys**

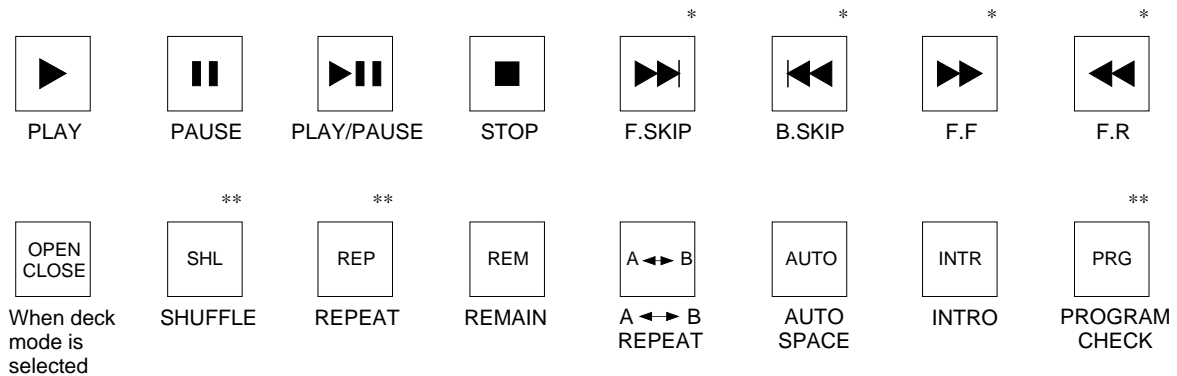

\*/\*\* Multiple functions can be combined.

- LCDs can be driven directly. This includes time display, music calendar, remaining tunes and other display functions.
- NEC format remote control input possible; direct tune selection through keypad and other functions can be added.
- Supports auxiliary functions including synchronization input and double-speed playback.
- Easy switching between deck and portable equipment using external pins.
  - (i) With deck type selected, performs tray loading function.
  - (ii) With portable type selected, displays detection of weak battery and executes emergency termination when battery voltage is low.
 In this way, it functions specific to the system required.
- An simple tracking gain/balance function is built-in, enabling adjustment of the tracking gain/balance according to the disc.

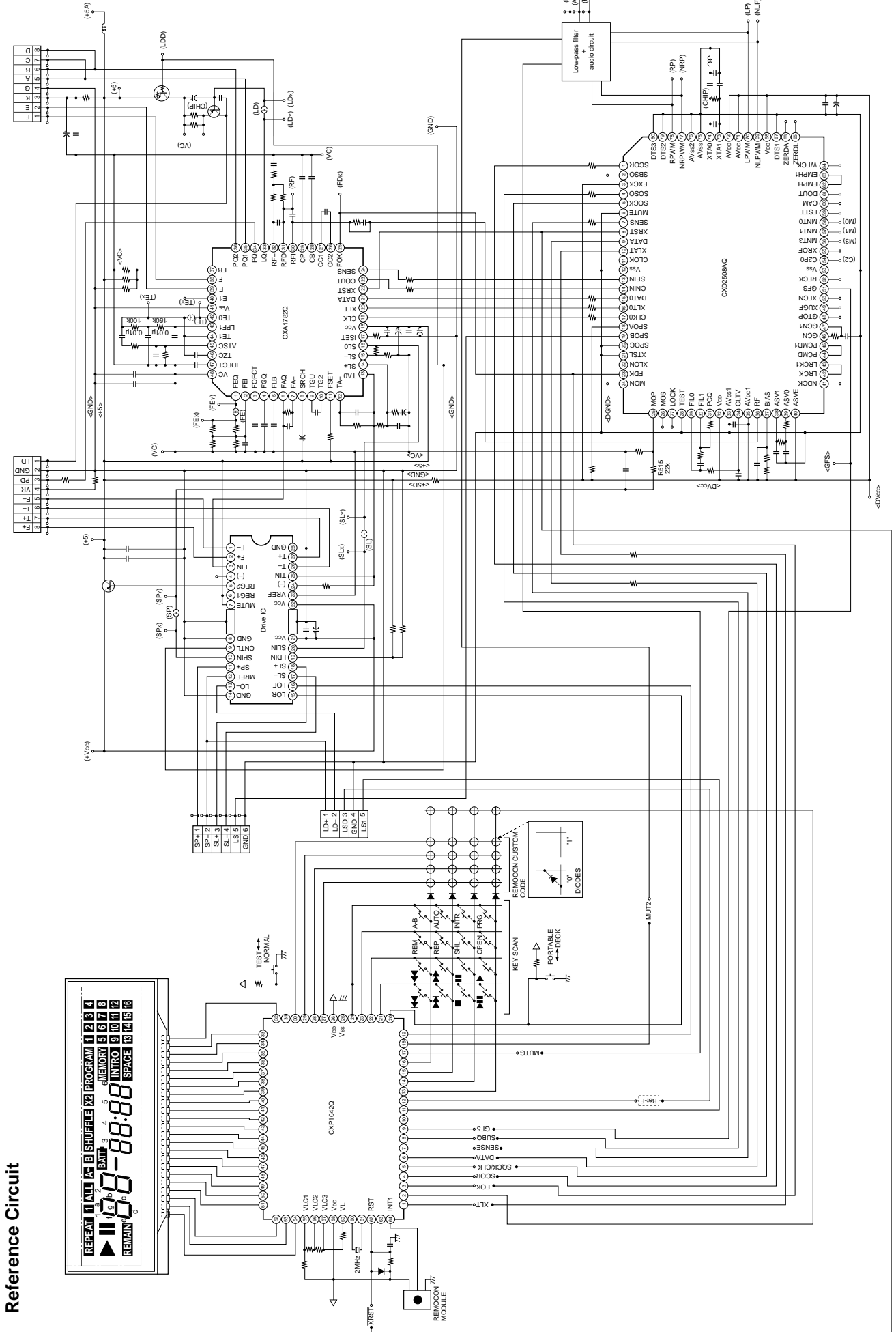

Pin Configuration and Pin Description

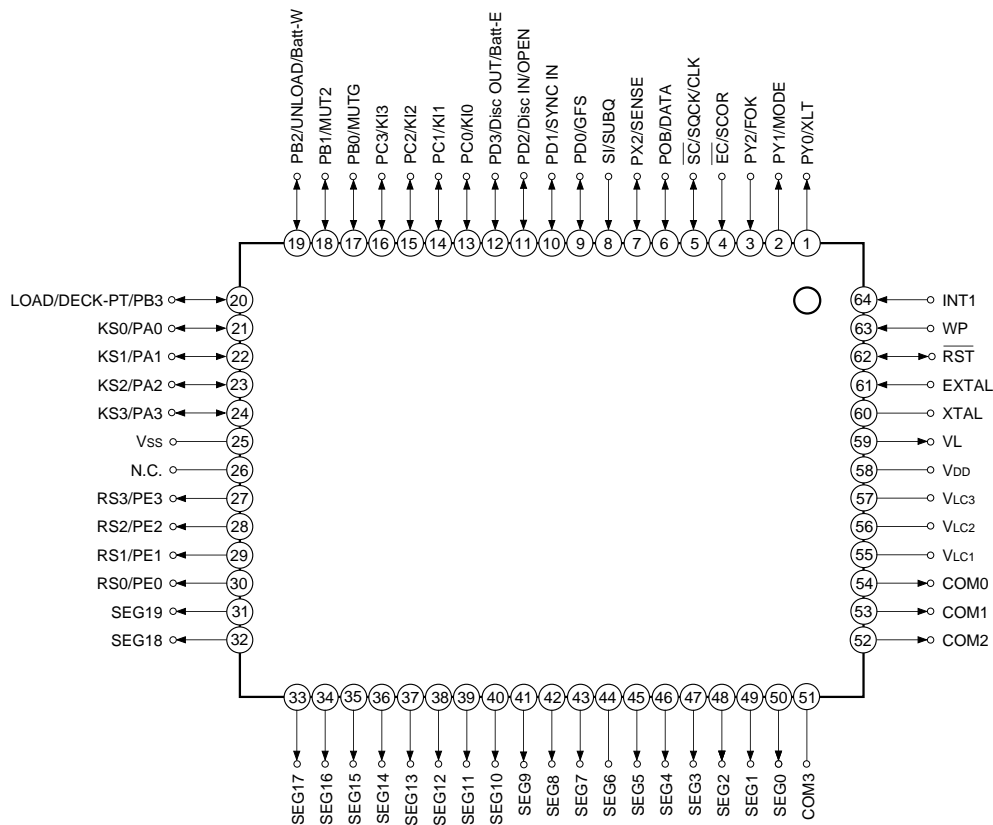

Pin No.	Symbol	Function code	I/O	Description
1	PY0	XLT	O	Latch output; connect to XLAT of CXD2507A/2508A
2	PY1	MODE	O	Setting scan output signal for microcomputer operation mode
3	PY2	FOK	I	Inputs focus condition; connect to CXA1782B FOK
4	PY3	SCOR	I	SCOR input; connect to CXD2507A/2508A SCOR
5	PX0	SQCK/CLK	O	SUB-Q reading clock output; 8-bit data clock output
6	PX1	DATA	O	8-bit data output
7	PX2	SENSE	I	Sense input (monitor for different systems); connect to CXD2507A/2508A SENS
8	PX3	SUBQ	I	SUB-Q code input port; connect to CXD2507A/2508A SQSO
9	PD0	GFS	I	Monitors disc state; connect to CXD2507A/2508A GFS
10	PD1	SYNC IN	I	Used to start the CD synchronously with external equipment (cassette deck, etc). Starts at falling edge ( $\nabla$ )
11	PD2	Disc IN*1/ OPEN	I	Switch to "L" when tray enters unit in deck mode, or when lid is closed in portable mode
12	PD3	Disc Out*1/ Batt-E	I	Switch to "L" when tray is open in deck mode, and when there are no batteries in portable mode
13	PC0	KI0	I	Key scan input port; reads the remote control custom code on reset or startup and setting state of the microcomputer operation mode
14	PC1	KI1	I	
15	PC2	KI2	I	
16	PC3	KI3	I	

Pin No.	Symbol	Function code	I/O	Description
17	PB0	MUTG	O	Turns mute on when mute signal is "H"; turned on when unit is opened or stopped
18	PB1	MUT2	O	Turns mute on when "L", turned on when unit is opened, stopped, paused or accessed.
19	PB2	UNLOAD/ Batt-W	I/O	In deck mode, output to tray loading motor; in portable mode, output to battery warning display
20	PB3	LOAD/ DECK-PT	I/O	In deck mode, indicates tray loading motor operation; on "L" detection immediately after reset, performs portable mode branching
21	PA0	KS0	O	Key scan output signal
22	PA1	KS1	O	
23	PA2	KS2	O	
24	PA3	KS3	O	
25	Vss	Vss		Connect to GND
26	N.C.	NC		Do not connect to anything
27	PE3	RS3	O	RMC customer code scan signal
28	PE2	RS2	O	
29	PE1	RS1	O	
30	PE0	RS0	O	
31	SEG19	—		Unused (do not connect to anything)
32	SEG18	SEG18	O	Connect to LCD (refer to LCD example)
33	SEG17	SEG17	O	
34	SEG16	SEG16	O	
35	SEG15	SEG15	O	
36	SEG14	SEG14	O	
37	SEG13	SEG13	O	
38	SEG12	SEG12	O	
39	SEG11	SEG11	O	
40	SEG10	SEG10	O	
41	SEG9	SEG9	O	
42	SEG8	SEG8	O	
43	SEG7	SEG7	O	
44	SEG6	SEG6	O	
45	SEG5	SEG5	O	
46	SEG4	SEG4	O	
47	SEG3	SEG3	O	
48	SEG2	SEG2	O	
49	SEG1	SEG1	O	
50	SEG0	SEG0	O	

Pin No.	Symbol	Function code	I/O	Description
51	COM3	COM3	O	Connect to LCD (refer to LCD example)
52	COM2	COM2	O	
53	COM1	COM1	O	
54	COM0	COM0	O	
55	VLC1			LCD bias power supply
56	VLC2			
57	VLC3			
58	V <sub>DD</sub>	V <sub>DD</sub>		V <sub>DD</sub>
59	VL		O	LCD bias power supply
60	XTAL	XTAL		Connect to a 2MHz oscillator
61	EXTAL	EXTAL	I	Connect to a 2MHz oscillator
62	$\overline{\text{RST}}$	$\overline{\text{Reset}}$	I/O	Connect reset
63	WP		I	Not used (connect to V <sub>SS</sub> or V <sub>DD</sub> )
64	INT1	RMC	I	Connect to remote control input and remote control module

(Mentioned here after with Pin No./Function code.)

The expansion port of the CXD2507A/2508A is used to detect the LD on/off output, limit switch input and tray open/close input.

#### CXD2507A/2508A

Pin No.		Symbol	Function code	I/O	Description
2507A	2508A				
61	19	SPOB	LIMSW	I	Limit switch input. "L" when the pickup is at the innermost track.
64	22	XLON	LDON	O	LD on/off "L": on, "H": off At this point, switch the IC whose one driver output functions also as spindle loading motor output.
63	18	SPOD	DISC OUT*2 (OPEN)	I	Goes "L" when the tray is fully opened.
		SPOA			
62	20	SPOC	DISC IN*2 (CLOSE)	I	Goes "L" when the tray is closed.

\*1, \*2

The tray switch is determined according to the state where Pin 2 (PY1/MODE) and Pin 16 (PC3/KI3) is connected immediately after reset or not.

Connected: DSP expansion port used

Not connected: Microcomputer port used

However, use the microcomputer port when the OPEN/Batt-E function is employed for portable mode.

The selected mute (Pin 2 (PY1/MODE) or Pin 15 (PC2/KI2)) is used to identify which of the CXD2507A or CXD2508A is employed for DSP.

Therefore, select the suitable method for the used DSP.

CXD2508A: DAC mute selected

CXD2507A: DSP mute selected

LCD Example

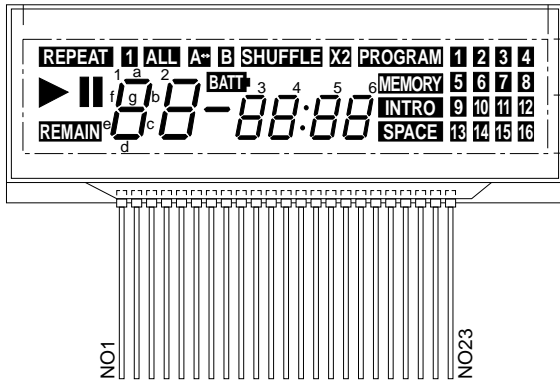
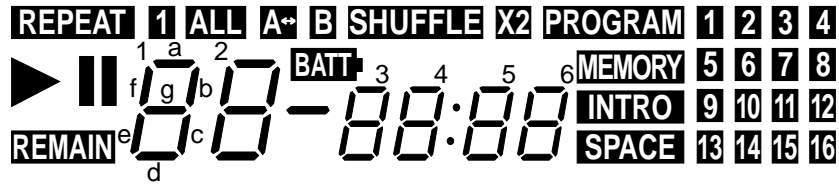

No.	COM. 3	COM. 2	COM. 1	COM. 0	Function code
1				COM. 0	COM0
2			COM. 1		COM1
3		COM. 2			COM2
4	COM. 3				COM3
5	REMAIN		▶	REPEAT	SEG0
6	1d	1e	1f	1 (Left)	SEG1
7	1c	1g	1b	1a	SEG2
8	2d	2e	2f	ALL	SEG3
9	2c	2g	2b	2a	SEG4
10		—	B	A↔	SEG5
11	3d	3e	3f	BATT	SEG6
12	3c	3g	3b	3a	SEG7
13	4d	4e	4f	SHUFFLE	SEG8
14	4c	4g	4b	4a	SEG9
15	5d	5e	5f	:	SEG10
16	5c	5g	5b	5a	SEG11
17	6d	6e	6f	×2	SEG12
18	6c	6g	6b	6a	SEG13
19	SPACE	INTRO	MEMORY	PROGRAM	SEG14
20	13	9	5	1 (Right)	SEG15
21	14	10	6	2	SEG16
22	15	11	7	3	SEG17
23	16	12	8	4	SEG18

**Key Matrix**

The CXP1042Q has the key matrix configuration shown below.

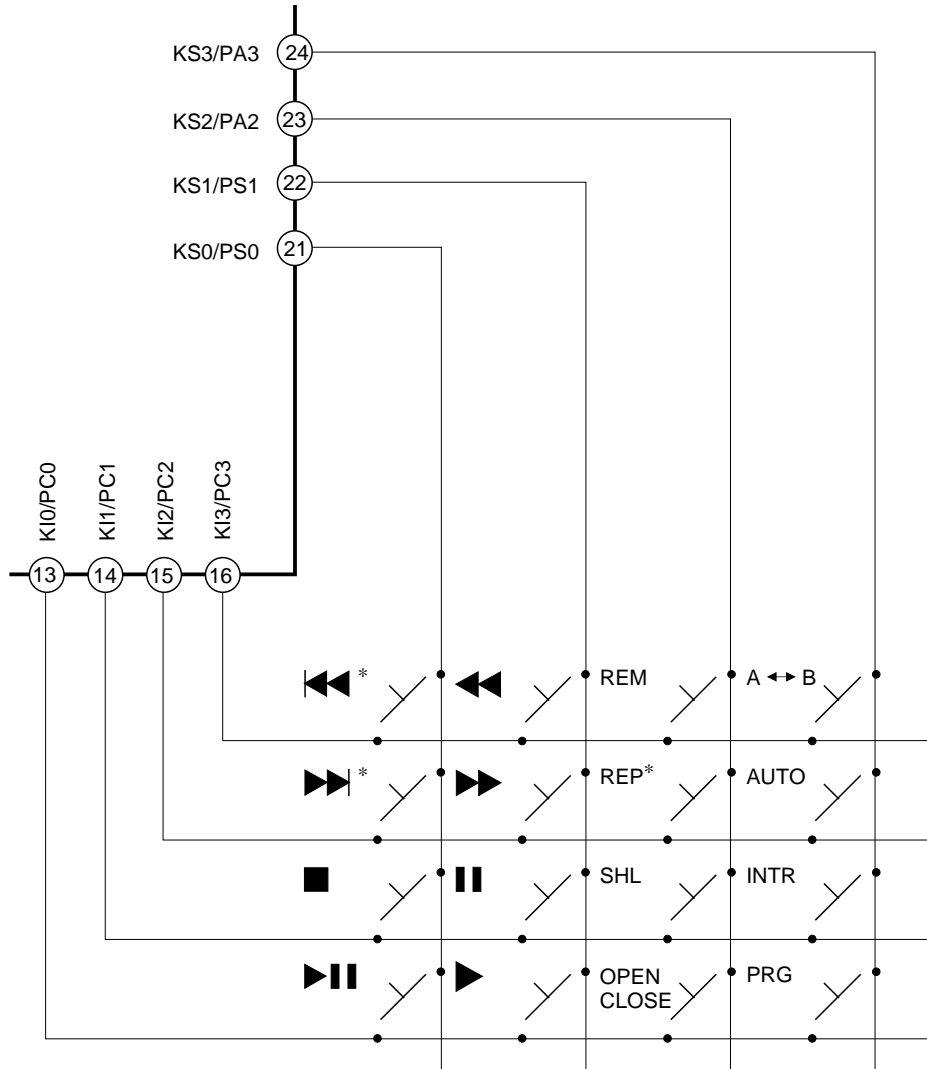

**\* Key combination mode**

◀▶, ▶▶ key and [REP] key have the combination mode which combines the other keys' functions.

1. ◀▶, ▶▶ key combination mode







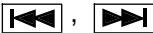
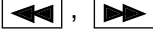
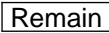
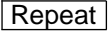

Combination mode is set when Pin 2 (MODE) and Pin 13 (K10) is not connected with diode. In this time, ◀▶ ▶▶ combines the ◀◀ ▶▶ function.

2. [REP] key combination mode

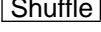
Combination mode is set when Pin 2 (MODE) and Pin 14 (K11) is not connected with diode. In this time, [REP] combines [SHL] and [PRG] functions.

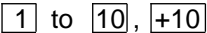
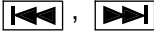

## List of Functions

1. Deck/Portable select Switches between deck mode and portable mode. In deck mode the tray loading function is activated; in portable mode, the battery detection function is activated.
2. Remote control input Accepts signals from a NEC format remote control unit. A 16-bit custom code can be selected.
3.  Keys to initiate playing can be selected.
4.  Performs tune selection.
5.  Performs fast-forward and rewind. The speed differs during Play and Pause.
6.  Can display Single Remain, All Remain, Program Remain.
7.  For repetition of one or of all tunes.
8.  For performance of A↔B repeat.
9.  Performed shuffled (random) playing.
10.  Inserts 4-second blanks between tunes.
11.  Plays the initial 10 seconds of a disc.
12.  Enables programming of up to 21 tunes.
13.  Enables direct tune selection using the keypad (for use with a remote control unit only).
14. Battery input A function for detection of reduced battery voltage is provided by the Batt-W and Batt-E pins (portable mode only).
15. Sync rate input For sync rate input and activation.
16. Double-speed playback Double-speed playback is executed only when  key is set to the independent mode and  key to repeat key if sync rate input is made for stop.
17. Loading function With the deck mode selected, tray loading is possible.
18. Key combining function The tune select and fast-forward keys can be combined or kept independent, and the repeat key and mode key can be selected.

**1. Deck mode/portable mode selection**

A feature of the CXP1042Q is its ability to be used in both deck-type and in portable equipment.

(a) Selection

Selection is executed through Pin 20 (LOAD/DECK-PT). Mode selection is determined by the condition of this pin immediately after reset of the CXP1042Q.

When Pin 20 (LOAD/DECK-PT) is high: Deck mode

When Pin 20 (LOAD/DECK-PT) is low: Portable/radio cassette mode

(b) Deck mode

- In deck mode the tray loading function is activated.
- Pins necessary for tray operation:

For the loading motor	For the tray SW
Pin 19 (UNLOAD/Batt-W) goes "H" when tray is ejected	Disc IN goes "L" when the tray is closed
Pin 20 (LOAD/DECK PT) goes "H" when tray is closed	Disc OUT goes "L" when tray is fully opened

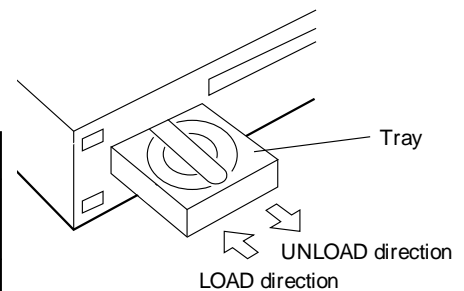

The tray switch state is input from the microcomputer port or DSP port according to the microcomputer operation mode.

- The relation between Pin 19 (UNLOAD/Batt-W) and Pin 20 (LOAD/DECK-PT) is as follows.

State	Pin 19/UNLOAD	Pin 20/LOAD
Open (stopped)	H	H
LOAD direction	L	H
UNLOAD direction	H	L
Close completed (stopped)	H	H

(c) Portable mode

- In portable mode, when the lid is closed the operation changes to TOC reading.
- Pin 20 (LOAD/DECK-PT) should be held "L".
- Pin 11 (Disc IN/OPEN) should be connected to a switch that makes the pin go "L" when the lid is closed.
- Two pins used in deck mode can be employed to detect a reduced battery voltage.
- When Pin 19 (UNLOAD/Batt-W) is made "L" through the reduced voltage detection circuit, BATT is displayed.
- In addition, when Pin 19 (UNLOAD/Batt-W) is "L", forcing Pin 12 (Disc OUT/Batt-E) "L" induces the STOP state.
- Input the Disc IN/OPEN and Disc OUT/Batt-E to the microcomputer port because the DSP expansion port can not be used for the portable mode.

(d) Selection of tray switch input port

The microcomputer port or DSP port can be selected for the tray switch input (Disc IN/OUT) according to the state where Pin 2 (MODE) and Pin 16 (KI3) is connected immediately after reset or not.

Not connected: Microcomputer port used

Connected with diode: DSP port used

However, use the microcomputer port when the OPEN/Batt-E function is employed for portable mode.

## Selection State of Operation Mode and Connection of Each Switch

Operation mode		Deck mode DSP expansion port used		Deck mode Microcomputer port used	Portable mode
		DSP: CXD2507A	DSP: CXD2508A		
Setting of mode selection pin	Pin 20 (LOAD/DEC-PT)	H	H	H	L
	Pin 2 (MODE) and Pin 16 (KI3)	Connected	Connected	Not connected	—
	Pin 2 (MODE) and Pin 15 (KI2)	Connected	Not connected	—	—
Connected switch	Lid open switch	—	—	—	Microcomputer Pin 11 (Disc IN/OPEN)
	Battery switch	—	—	—	Microcomputer Pin 19 (UNLOAD/Batt-W)
	Detection switch without battery	—	—	—	Microcomputer Pin 12 (Disc OUT/Batt-E)
	Tray open switch	SPOD for DSP	SPOA for DSP	Microcomputer Pin 11 (Disc IN/OPEN)	—
	Tray close switch	SPOC for DSP	SPOC for DSP	Microcomputer Pin 12 Disc OUT/Batt-E)	—
	Limit switch	SPOB for DSP	SPOB for DSP	SPOB for DSP	SPOB for DSP

**2. Selection of microcomputer operation mode**

In the CXP1042Q, functions can be selected according to the state where Pin 2 (MODE) and Pins 13 to 16 (KI0 to 3) are connected with diode immediately after reset or not.

Selection function	Tray switch Not connected: Microcomputer port Connected: DSP port	Mute Not connected: DAC mute Connected: DSP mute	REP key function Not connected: Combine mode Connected: Repeat key	◀▶, ▶▶ key function Not connected: Combine mode Connected: Independent mode
Applicable pin	Pin 16 (KI3)	Pin 15 (KI2)	Pin 14 (KI1)	Pin 13 (KI0)

**Example of connection**

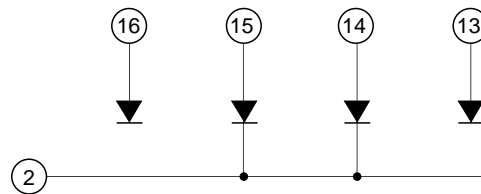

In this example, the microcomputer port and DSP mute (CXD2507A) is used for the tray switch, and the REP key is used as repeat key and ◀▶ / ▶▶ key is used in the combination mode.

• Tray switch selection

- Connected: Input the content of tray switch from the DSP expansion port
- Not connected: Input the content of tray switch from the microcomputer port

• Mute selection

- Connected: DSP mute (select for the CXD2507A used)
- Not connected: DAC mute (select for the CXD2508A used)

• ◀▶, ▶▶ key function selection

- Connected: ◀▶ / ▶▶, ▶▶ / ▶▶ key independent mode
- Not connected: ◀▶ / ▶▶, ▶▶ / ▶▶ key combination mode

**Operation for combination mode**

Function differs depending on length of time pressed and state of operation

- In stopped state: Functions as ◀▶, ▶▶ key regardless of the length of time pressed

If the length of time pressed for playback is:

- 0.5 seconds or less: Functions as ◀▶, ▶▶ key
- Longer than 0.5 seconds: Functions as ▶▶, ▶▶ key

• REP key function selection

- Connected: Functions as repeat key
- Not connected: Functions as combination mode

**Operation of combination mode**

Function differs depending on the state of operation

- In stopped state: Functions as program key
- In normal playback state: Switches between single-tune repeat, all-tune repeat and tune shuffle
- In program playback state: Switches between single-tune repeat and all the programmed tunes repeat

Select the independent mode for ◀▶, ▶▶ key and repeat key for REP key to execute the double-speed playback.

### 3. Mute function

The CXP1042Q has two mute pins, Pin 17 (MUTG...active high) and Pin 18 (MUT2...active low). The command transferred to the DSP and the state of mute pin differ depending on the selected mute method when mute is turned on.

- DAC mute (CXD2508A used)  
 When "mute on" is requested, set Pin 18 (MUT2) active and then transfer the attenuate command (A00000h) to the DAC.  
 Only when "open/stop" is requested, set Pin 17 (MUTG) active after approximately 32ms from the command transfer.
- DSP mute (CXD2507A used)  
 When "mute on" is requested, set Pin 17 (MUTG) and Pin 18 (MUT2) active and then transfer the mute command (A207F0h) to the DSP.

Note that A007F0h is transferred when mute is turned off both for DAC mute and DSP mute.

#### Timing chart for mute on

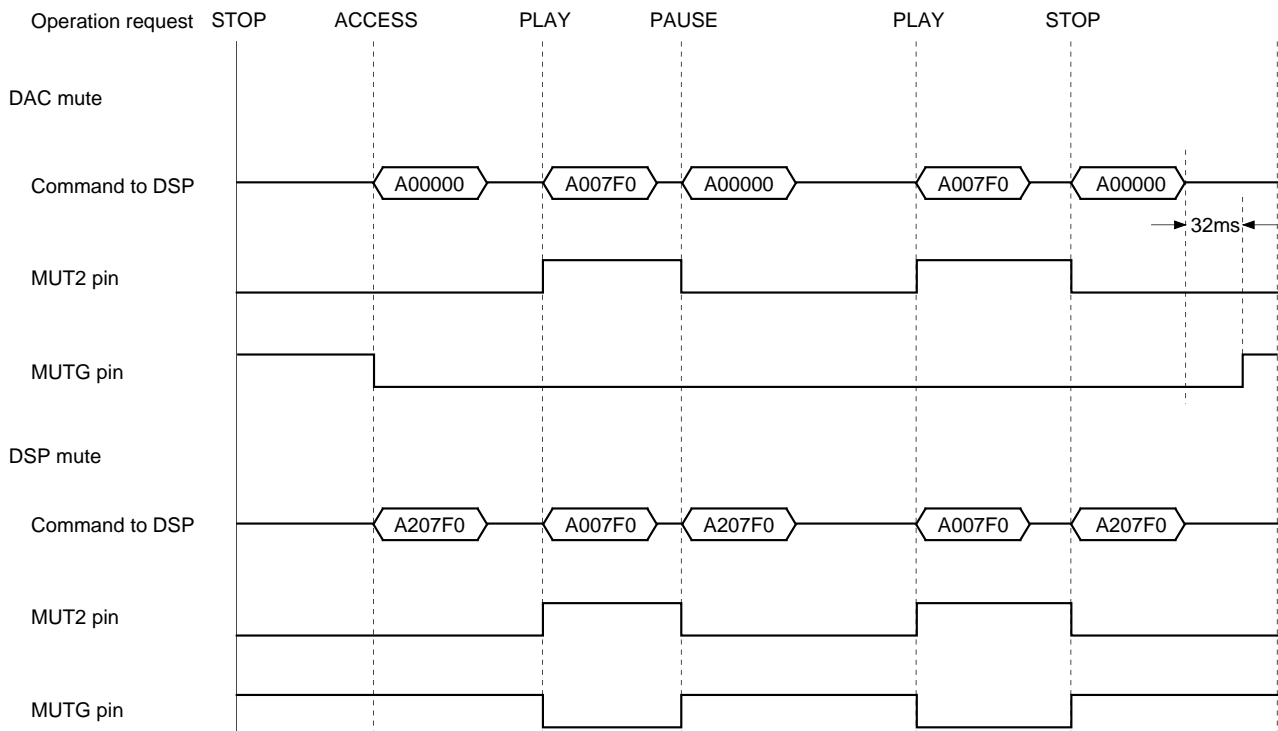

4. Remote control

Any NEC format remote control can be used. Please note that no other remote control units are supported.

(a) Format

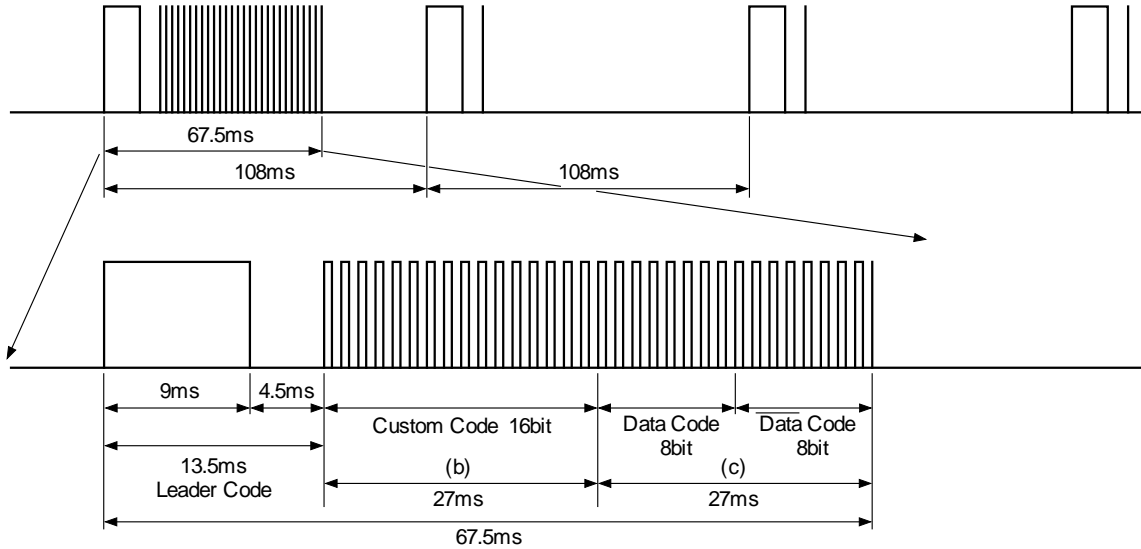

(b) Custom code setting

16 bits of the custom code can be set.

(c) Remote control data

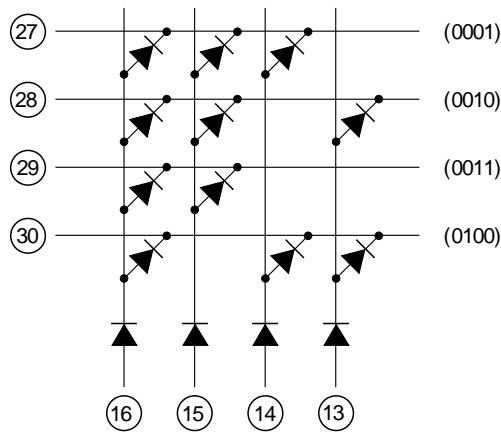

(Example: custom code "1234")

By forming a diode matrix, a single bit of data is created; adding a diode at each point sets that point to "0". Please use the above example as a reference.

This matrix is read only immediately after the power is turned on.

Code D7 ——— D0	Contents	Code D7 ——— D0	Contents
0 0 0 0 0 0 0	SHUFFLE	0 0 0 1 0 0 0 0	OPEN
0 0 0 0 0 0 0 1	Repeat	0 0 0 1 0 0 0 1	7
0 0 0 0 0 0 1 0	Remain	0 0 0 1 0 0 1 0	10
0 0 0 0 0 0 1 1	PROGRAM	0 0 0 1 0 0 1 1	▶
0 0 0 0 0 1 0 0	INTRO	0 0 0 1 0 1 0 0	▶
0 0 0 0 0 1 0 1	AUTO SPACE	0 0 0 1 0 1 0 1	8
0 0 0 0 0 1 1 0	A↔B	0 0 0 1 0 1 1 0	+10
0 0 0 0 0 1 1 1	—	0 0 0 1 0 1 1 1	9
0 0 0 0 1 0 0 0	—	0 0 0 1 1 0 0 0	—
0 0 0 0 1 0 0 1	1	0 0 0 1 1 0 0 1	5
0 0 0 0 1 0 1 0	◀◀	0 0 0 1 1 0 1 0	◀▶
0 0 0 0 1 0 1 1		0 0 0 1 1 0 1 1	6
0 0 0 0 1 1 0 0	—	0 0 0 1 1 1 0 0	—
0 0 0 0 1 1 0 1	4	0 0 0 1 1 1 0 1	2
0 0 0 0 1 1 1 0	◀◀	0 0 0 1 1 1 1 0	▶▶
0 0 0 0 1 1 1 1	■	0 0 0 1 1 1 1 1	3

The data on the receiving end is as shown above and cannot be changed.

For the transmitting end, please refer to the specifications of the transmitting side chip.

5. To play in deck mode

(a) Turn the power on.

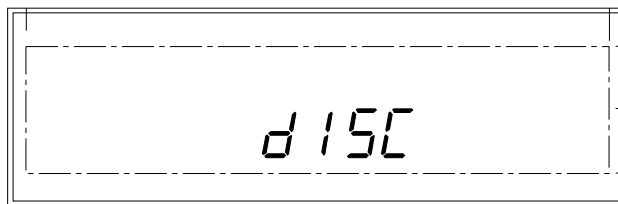
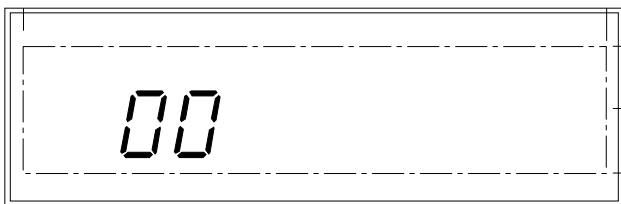

- If the tray is in the open state, a disc can be loaded.
- A focus search is performed, and if a disc is already loaded, the TOC is read.
- If a disc is not loaded, "disc" is displayed.

(b) When the TOC has been read

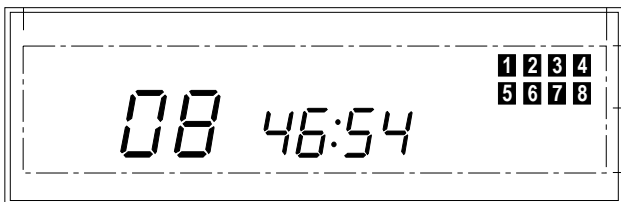

(c) To load a disc

- Press **OPEN**

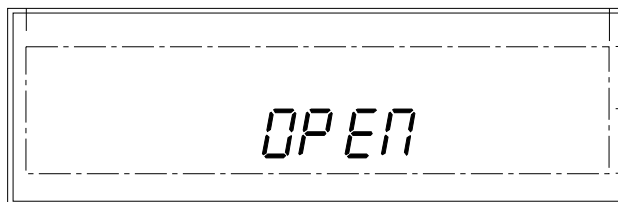

(d) To play the disc

- Press **▶** or **▶||**.

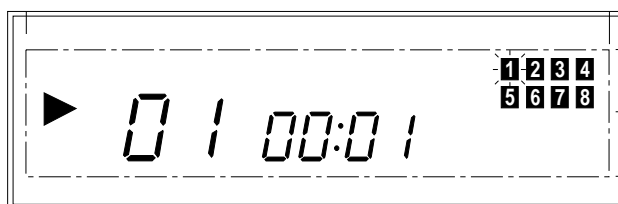

(e) To pause during playing

- Press **||** or **▶||**.

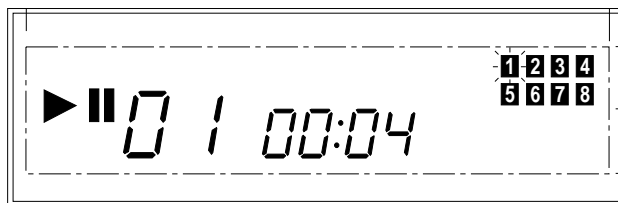

(f) To stop playing

- Press **■**

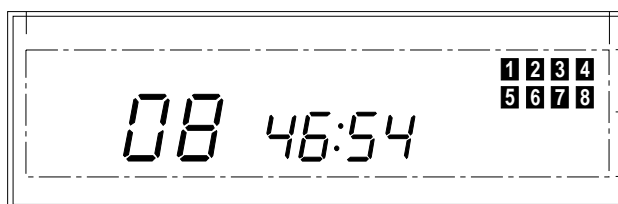

6. To play in portable mode

(a) Turn the power on.

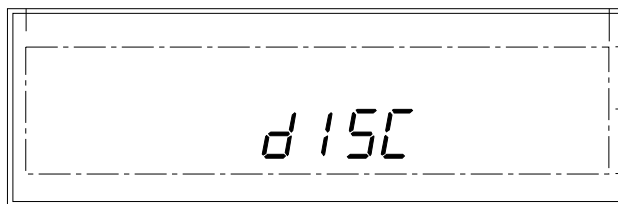
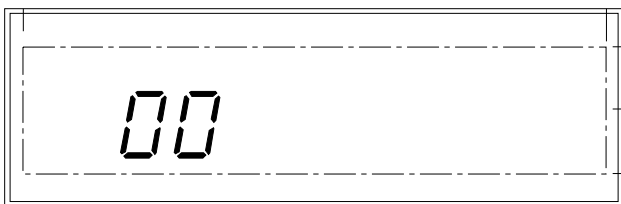

- When the lid is open, no operation takes place.
- A focus search is performed, and if a disc is already loaded, the TOC is read.
- When no disc is loaded, "disc" is displayed.

(b) When the TOC has been read

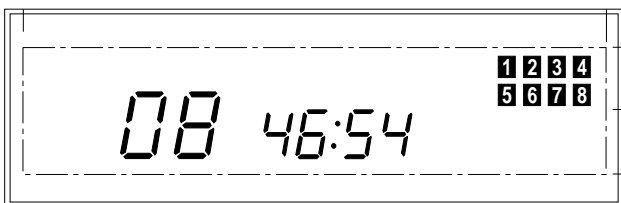

(c) To load a disc

- Open the lid.

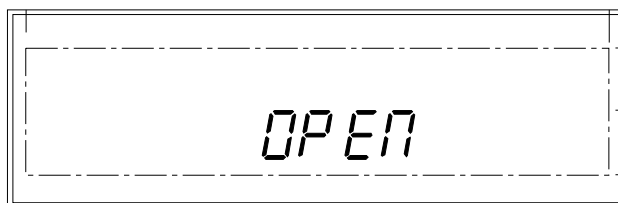

(d) To play the disc

- Press  or .

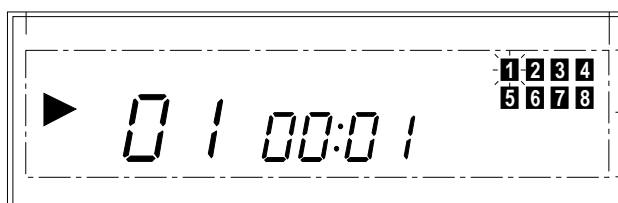

(e) To pause during playing

- Press  or .

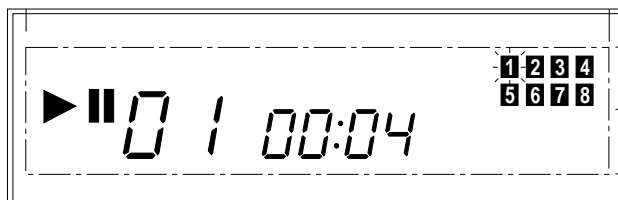

(f) To stop playing

- Press .

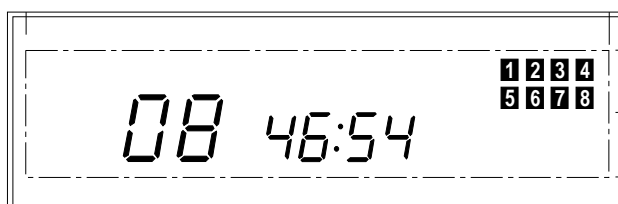



Functions common to the deck mode and the portable/radio cassette mode.

7. To begin listening from a specific tune

- Press or .  
(Example: Sixth tune specified)
- If the keys are pressed continuously, the tune number continues to change.
- After a few seconds playing starts.

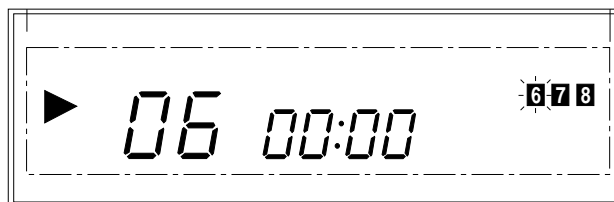
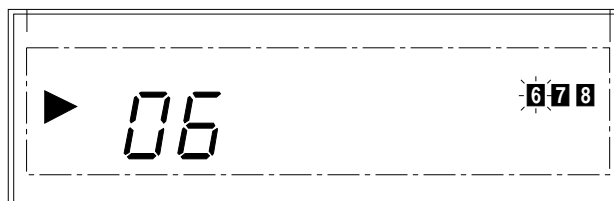

→tune can be specified directly only by remote control.

Tunes **1** to **10** can be specified directly using the corresponding keys. For tunes following tune 10, the following procedure is used.

- Press **+10** .
- Following this, press a key from **1** to **10**.
- If there are not more than 10 tunes on the disc, the **+10** key is invalid.

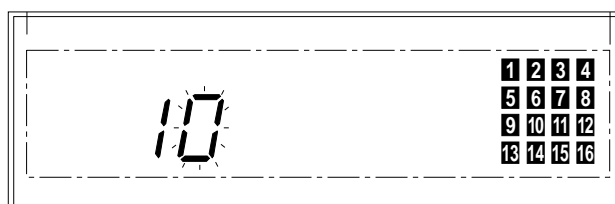

8. To move to a desired place on the disc

- During play, press or .
- The player moves at high speed, emitting a small sound during play, or without emitting a sound during pause.

9. To check the time remaining on the disc

- Press **Remain**.
- When pressed once, the time remaining for the tune currently being played is displayed. When the tune being played is beyond the 32nd tune, " " is displayed.
- Pressing **Remain** once again causes the time remaining on the disc to be displayed.
- Pressing **Remain** once again restores the normal display.

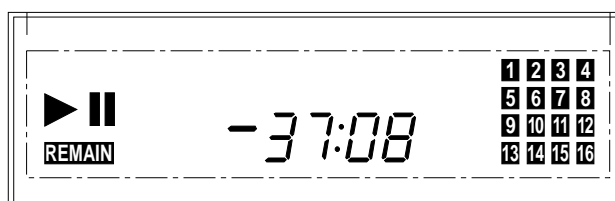
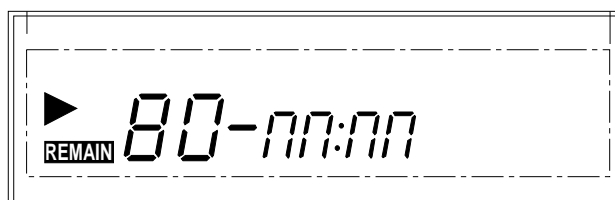
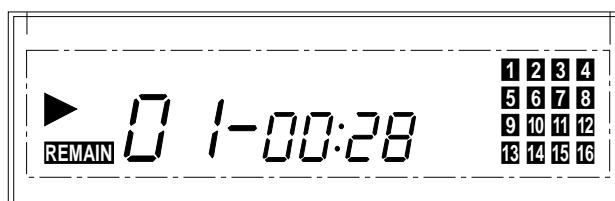

**10. To repeat a tune or tunes**

- Press **Repeat**.
- Pressing once causes one tune to be repeated.
- Pressing once more causes all tunes to be repeated. In program playback mode, all the programmed tunes to be repeated.
- Pressing once more turns off Repeat mode.

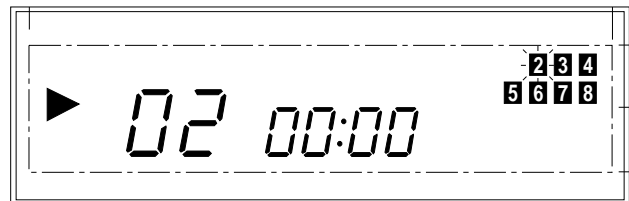
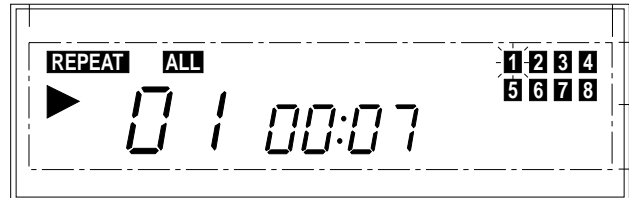
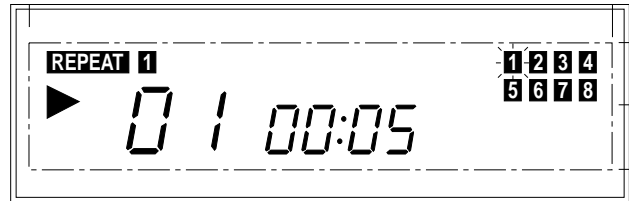

**11. A↔B repeat function**

Used to repeatedly play the part of the disc from a certain point A to a certain point B.

- At the starting point of the interval A↔B, press **A↔B**.
- At the ending point of the interval A↔B, once again press **A↔B**. On doing so, the interval A↔B will be played repeatedly.
- To stop repeated A↔B play, press **A↔B** once again, or press **Repeat**.

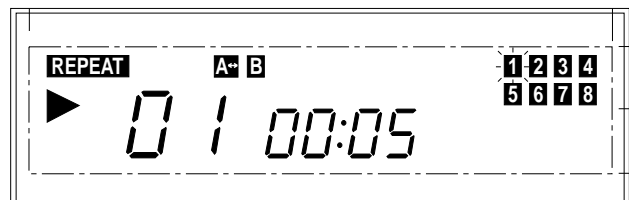
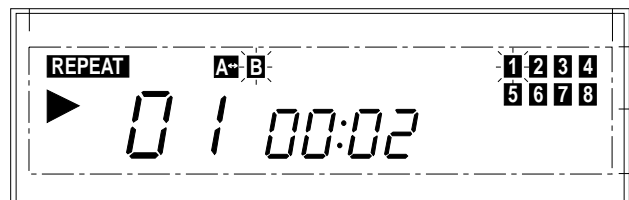

**12. To play tunes out of order (Shuffle)**

- Press **SHUFFLE**.
- Press **▶** or **▶||**.
- Play starts.
- If **SHUFFLE** is pressed during play, shuffled play starts from the end of the current tune.

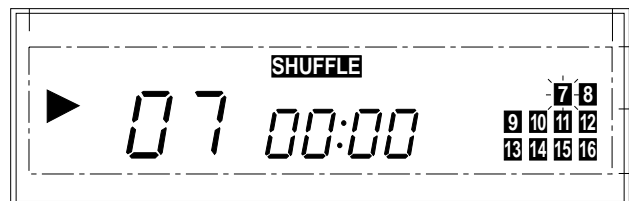
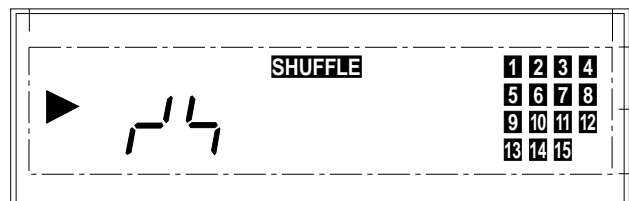
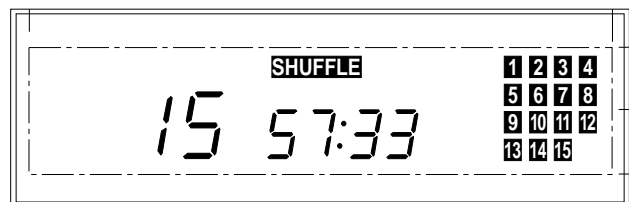

**13. To insert a 4-second blank between tunes**

When dubbing onto tapes or in similar situations, it is sometimes necessary to insert blanks between tunes.

- Press **AUTO**.
- Pressing **AUTO** once more cancels the function.

**Note)** When playing the introduction and when **▶▶** is pressed, blank is not inserted.

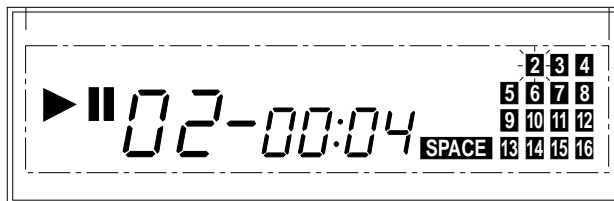

**14. To listen to the disc introduction only for 10 seconds**

- Press **INTRO**.
- Pressing **INTRO** once more cancels the function.
- It is possible to play the introduction during Shuffle and Program operation also.
- In Repeat All mode, introduction play does not halt even when the last tune is reached, but is repeated.

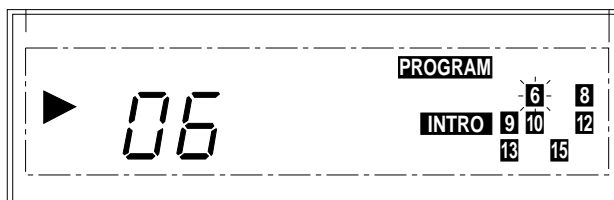
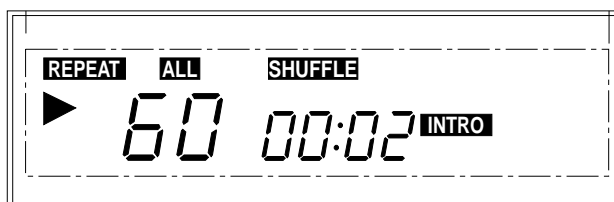
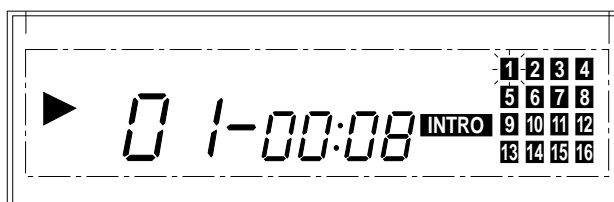

15. Program play

Up to 21 tunes can be programmed for listening and played.

(a) Press **PROG**.

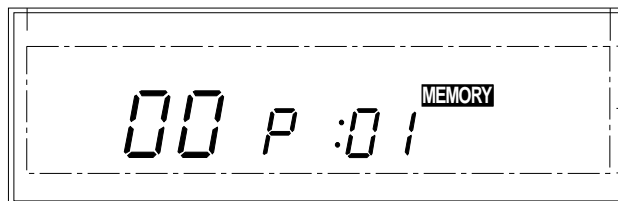

(b) Select a tune number using the **◀◀** and **▶▶** keys. (The remote control **1** to **10** and **+10** keys can also be used.)

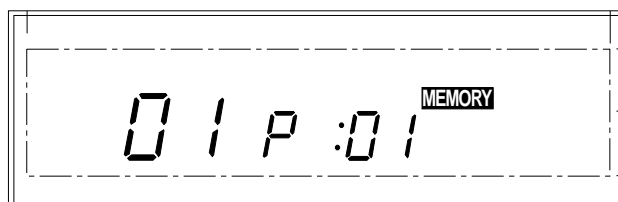

(c) Press **PROG**. Repeat steps (b) and (c) for all the tunes desired.

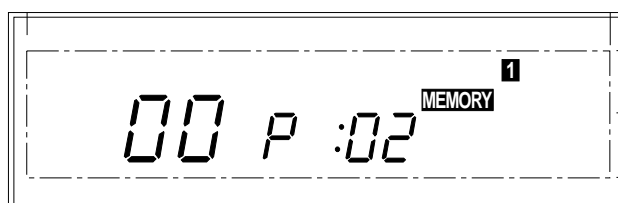

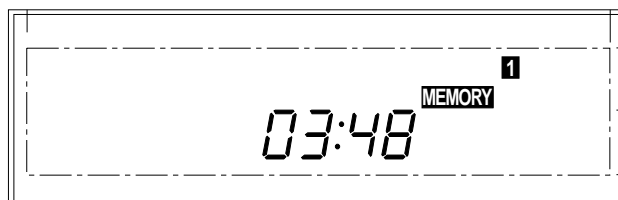

(d) Indicate that input is completed by pressing **■**.

(e) When **Remain** is pressed while in state (b), the total remaining time is displayed while the key is pressed. By using the **◀◀** and **▶▶** keys with the **Remain** key, the total play time can be checked while programming.

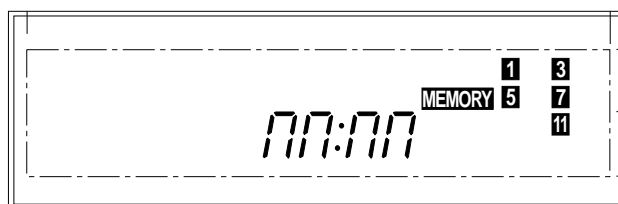

(f) If, among the tunes included in programming, any one or more tunes is numbered above 32, the display shown on the right appears.



(g) Pressing  or  begins play.

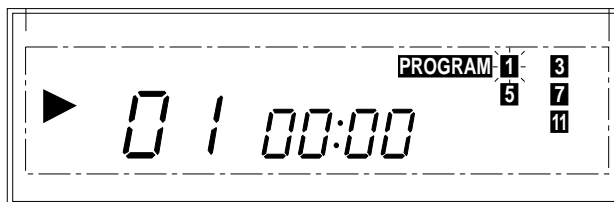

(h) The music calendar of a tune disappears as the tune is completed.

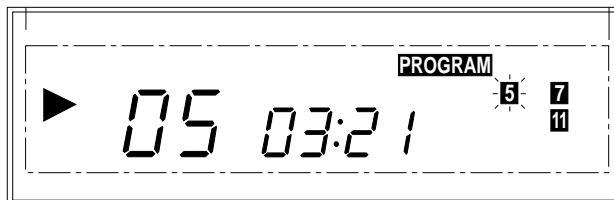

(i) In the above state, pressing the **Remain** key causes the remaining time of the tune being played to display.

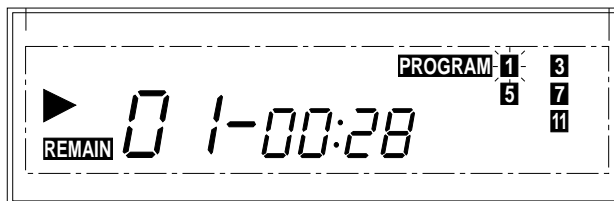

(j) If the tune being played is numbered above 32, the display shown on the right appears.

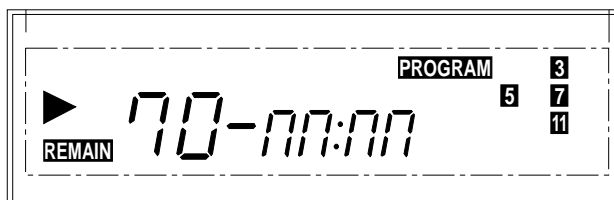

(k) During display of the remaining time of the current tune, if the **Remain** key is pressed once more the remaining time for all the programmed tunes is displayed.

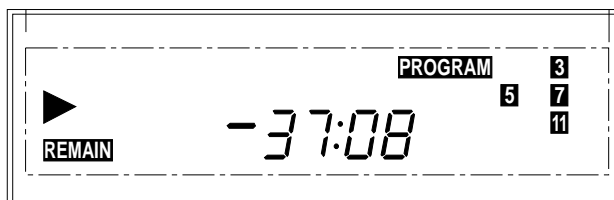

(l) If any of the tunes remaining to be played is numbered above 32, the display shown on the right appears.

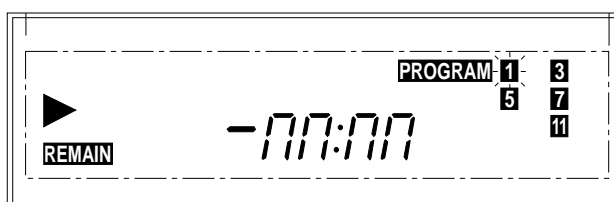

(m) To stop playing press .

To play the previous program again, press **PROG** once more and set Memory mode. The contents of the previous program are stored and can be used again.

When the tray or lid is opened, the program contents are cleared.

**16. Battery input (in portable mode)**

Using pins: Pin 19 (UNLOAD/Batt-W)  
Pin 12 (Disc OUT/Batt-E)

- (a) When Batt-W is "L", the BATT lamp lights.
- (b) When both Batt-W and Batt-E are "L", the unit is forced to stop, "disc" is displayed, and keys no longer function.

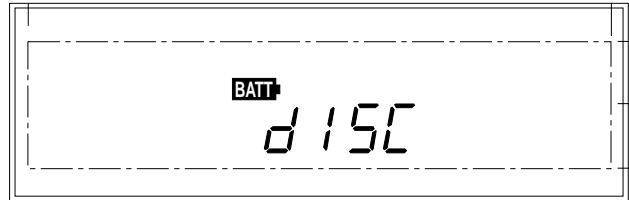

**17. Sync rate function**

This function is used to play the CD player in synchronization with the record key of a cassette deck.

Operation is triggered by  $\bar{\downarrow}$  (the falling edge), and differs depending on the state of the CD player.

- (a) While stopped
  - The CD player enters the Play state, and starts after 4 seconds. During this time, double-speed playback is executed when ◀◀, ▶▶ key is set to the independent mode and REP key to repeat key.
- (b) During play pause
  - The CD player pauses at the beginning of the current tune, and after 4 seconds begins playing.
- (c) While open
  - When the tray is loaded, the player enters the Play state.
  - Output is not at double speed even for any operation mode.
- (d) During shuffled play
  - Play is shuffled, and (a) and (b) are executed.
- (e) During program play
  - Program play begins, and (a) and (b) are executed.

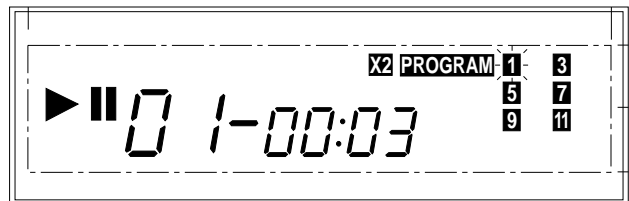
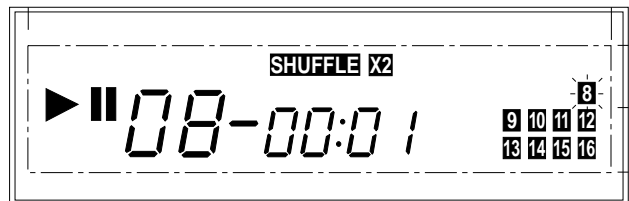
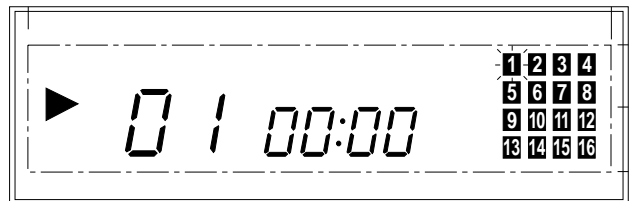
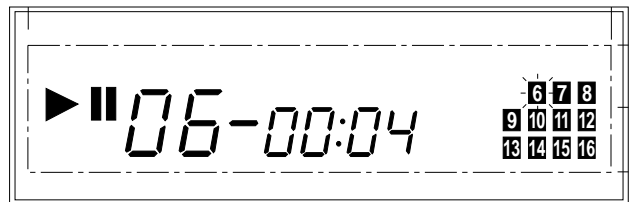
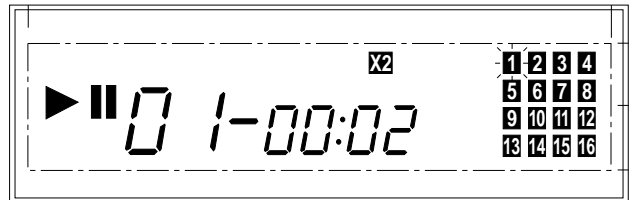

## Absolute Maximum Ratings

(Ta = -20 to +75°C, Vss = 0V)

Item	Symbol	Rating	Unit	Remarks
Supply voltage	V <sub>DD</sub>	-0.3 to +7.0	V	
LCD bias voltage	V <sub>LC1</sub> , V <sub>LC2</sub> , V <sub>LC3</sub>	-0.3 to +7.0* <sup>1</sup>	V	
Input voltage	V <sub>IN</sub>	-0.3 to +7.0* <sup>1</sup>	V	
Output voltage	V <sub>OUT</sub>	-0.3 to +7.0* <sup>1</sup>	V	
High level output current	I <sub>OH</sub>	-5	mA	General purpose port 1 pins* <sup>2</sup>
High level total output current	∑I <sub>OH</sub>	-50	mA	Total for all output pins
Low level output current	I <sub>OL</sub>	15	mA	General purpose port 1 pins* <sup>2</sup>
Low level total output current	∑I <sub>OL</sub>	50	mA	Total for all output pins
Operating temperature	T <sub>opr</sub>	-20 to +75	°C	
Storage temperature	T <sub>stg</sub>	-55 to +150	°C	
Allowable power dissipation	P <sub>D</sub>	600	mW	QIP

\*<sup>1</sup> V<sub>LC1</sub>, V<sub>LC2</sub>, V<sub>LC3</sub>, V<sub>IN</sub> and V<sub>OUT</sub> must not exceed V<sub>DD</sub> + 0.3V.

\*<sup>2</sup> PA to PD, PX0 to PX2, PY0, PY1 and, when the mask option port is selected, PE and PF.

**Note)** Usage exceeding absolute maximum ratings may permanently impair the LSI. Normal operation should be conducted under the recommended operating conditions. Exceeding these conditions may adversely affect the reliability of the LSI.

## Recommended Operating Conditions

(Vss = 0V)

Item	Symbol	Min.	Max.	Unit	Remarks
Supply voltage	V <sub>DD</sub>	3.5	5.5	V	
LCD bias voltage	V <sub>LC1</sub> , V <sub>LC2</sub> , V <sub>LC3</sub>	V <sub>SS</sub>	V <sub>DD</sub>	V	LCD power supply range* <sup>3</sup>
High level input voltage	V <sub>IH</sub>	0.7V <sub>DD</sub>	V <sub>DD</sub>	V	
	V <sub>IHS</sub>	0.8V <sub>DD</sub>	V <sub>DD</sub>	V	Hysteresis input* <sup>4</sup>
	V <sub>IH<sub>EX</sub></sub>	V <sub>DD</sub> - 0.4	V <sub>DD</sub> + 0.3	V	EXTAL pin* <sup>5</sup>
Low level input voltage	V <sub>IL</sub>	0	0.3V <sub>DD</sub>	V	
	V <sub>ILS</sub>	0	0.2V <sub>DD</sub>	V	Hysteresis input* <sup>4</sup>
	V <sub>ILEX</sub>	-0.3	0.4	V	EXTAL pin* <sup>5</sup>
Operating temperature	T <sub>opr</sub>	-20	+75	°C	

\*<sup>3</sup> The optimum value will vary depending on the characteristics of the liquid crystal display.

\*<sup>4</sup> Each pin of INT1, WP, PX0, PX3, PY2, PY3, and  $\overline{\text{RST}}$ .

\*<sup>5</sup> Specified only for external clock input.

Electrical Characteristics

DC characteristics

(Ta = -20 to +75°C, Vss = 0V)

Item	Symbol	Pin	Conditions	Min.	Typ.	Max.	Unit
High level output voltage	V <sub>OH</sub>	PA to PE*1 PX0 to PX2 PY0, PY1	V <sub>DD</sub> = 4.5V, I <sub>OH</sub> = -10μA	4.0			V
			V <sub>DD</sub> = 4.5V, I <sub>OH</sub> = -200μA	2.4			V
Low level output voltage	V <sub>OL</sub>	VL (V <sub>OL</sub> only) RST (V <sub>OL</sub> only)	V <sub>DD</sub> = 4.5V, I <sub>OL</sub> = 1.8mA			0.4	V
			V <sub>DD</sub> = 4.5V, I <sub>OL</sub> = 3.6mA			0.6	V
Input current	I <sub>IH</sub>	EXTAL*2	V <sub>DD</sub> = 5.5V, V <sub>IL</sub> = 0.4V	0.5		40	μA
	I <sub>I<sub>LE</sub></sub>			-0.5		-40	μA
	I <sub>I<sub>LR</sub></sub>	RST*3		-1.5		-400	μA
	I <sub>IL</sub>	PA to PF, PX0 to PX2, PY0, PY1				-2.0	mA
High impedance input/output leakage current	I <sub>Iz</sub>	PX3, PY2, PY3, INT1, WP	V <sub>DD</sub> = 5.5V			±10	μA
Common output impedance	R <sub>COM</sub>	COM0 to COM3	V <sub>DD</sub> = 5V V <sub>LC1</sub> = 3.75V		3	5	kΩ
Segment output impedance	R <sub>SEG</sub>	SEG0 to SEG19	V <sub>LC2</sub> = 2.5V V <sub>LC3</sub> = 1.25V		5	15	kΩ
Supply current	I <sub>DD</sub>	V <sub>DD</sub>	V <sub>DD</sub> = 5.5V external clock, 1MHz; all output pins open		2	6	mA
	I <sub>DDSP</sub>						
	I <sub>DDS</sub>						
Input pin capacitance	C <sub>IN</sub>	All pins other than V <sub>LC1</sub> to V <sub>LC3</sub> , COM0 to COM3, SEG0 to SEG15, SEG16 to SEG19, V <sub>DD</sub> , V <sub>SS</sub>	Clock 1MHz, 0V for pins other than those measured.		10	20	pF

\*1 Pull-up resistances selected for each of pins PA to PF, PY0 and PY1.

\*2 Crystal or ceramic oscillator circuit selected.

\*3 Pull-up resistance selected for the  $\overline{\text{RST}}$  pin.



AC Characteristics

(1) Clock timing

(Ta = -20 to +75°C, VDD = 3.5 to 5.5V, VSS = 0V)

Item	Symbol	Pin	Conditions	Min.	Max.	Unit
System clock frequency	fc	XTAL EXTAL	Figs. 1, 2	2	2	MHz
System clock input pulse width	t <sub>XL</sub> t <sub>XH</sub>	EXTAL	Figs. 1, 2	90	200	ns
System clock input rise, fall times	t <sub>CR</sub> t <sub>CF</sub>					
Event count clock input pulse width	t <sub>EL</sub> t <sub>EH</sub>	PY3/ $\overline{EC}$	Fig.3	t <sub>sys</sub> * + 0.05		μs
Event count clock input rise, fall times	t <sub>ER</sub> t <sub>EF</sub>	PY3/ $\overline{EC}$	Fig.3		20	ms

\* t<sub>sys</sub> = 8/fc

**Note)** When accurately adjusting the frequency, conditions may differ from those of Fig. 2.

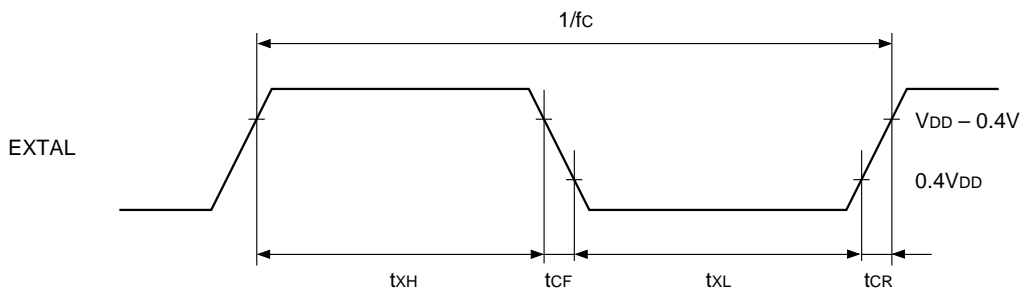

Fig. 1. Clock timing

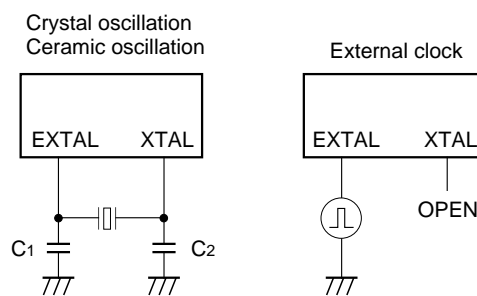

Fig. 2. Clock applied conditions

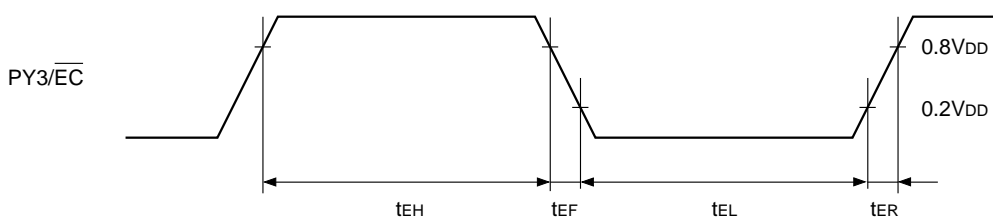

Fig. 3. Event count clock timing

(2) Serial transfer

( $T_a = -20$  to  $+75^\circ\text{C}$ ,  $V_{DD} = 3.5$  to  $5.5\text{V}$ ,  $V_{SS} = 0\text{V}$ )

Item	Symbol	Pin	Conditions	Min.	Max.	Unit
Serial transfer clock ( $\overline{\text{SC}}$ ) cycle time	$t_{\text{KCY}}$	$\overline{\text{SC}}$	Input mode	$t_{\text{sys}}/4 + 1.42$		$\mu\text{s}$
			Output mode	$t_{\text{sys}}$		$\mu\text{s}$
Serial transfer clock ( $\overline{\text{SC}}$ ) high-low level width	$t_{\text{KH}}$	$\overline{\text{SC}}$	Input mode	$t_{\text{sys}}/8 + 0.7$		$\mu\text{s}$
			Output mode	$t_{\text{sys}}/2 - 1.6$		$\mu\text{s}$
Serial data input set-up time (relative to $\overline{\text{SC}}$ )	$t_{\text{KL}}$	SI	$\overline{\text{SC}}$ input mode	0.1		$\mu\text{s}$
			$\overline{\text{SC}}$ output mode	0.2		$\mu\text{s}$
Serial data input hold time (relative to $\overline{\text{SC}}$ )	$t_{\text{SIK}}$	SI	$\overline{\text{SC}}$ input mode	$t_{\text{sys}}/8 + 0.5$		$\mu\text{s}$
			$\overline{\text{SC}}$ output mode	0.1		$\mu\text{s}$
Time delay from $\overline{\text{SC}}$ falling edge for high data output	$t_{\text{KSI}}$	SOB				$\mu\text{s}$
Delay time from $\overline{\text{SC}}$ falling edge for low data output	$t_{\text{KSOB}}$	SOB			$t_{\text{sys}}/8 + 0.5$	$\mu\text{s}$

Note)  $t_{\text{sys}}=8/f_c$

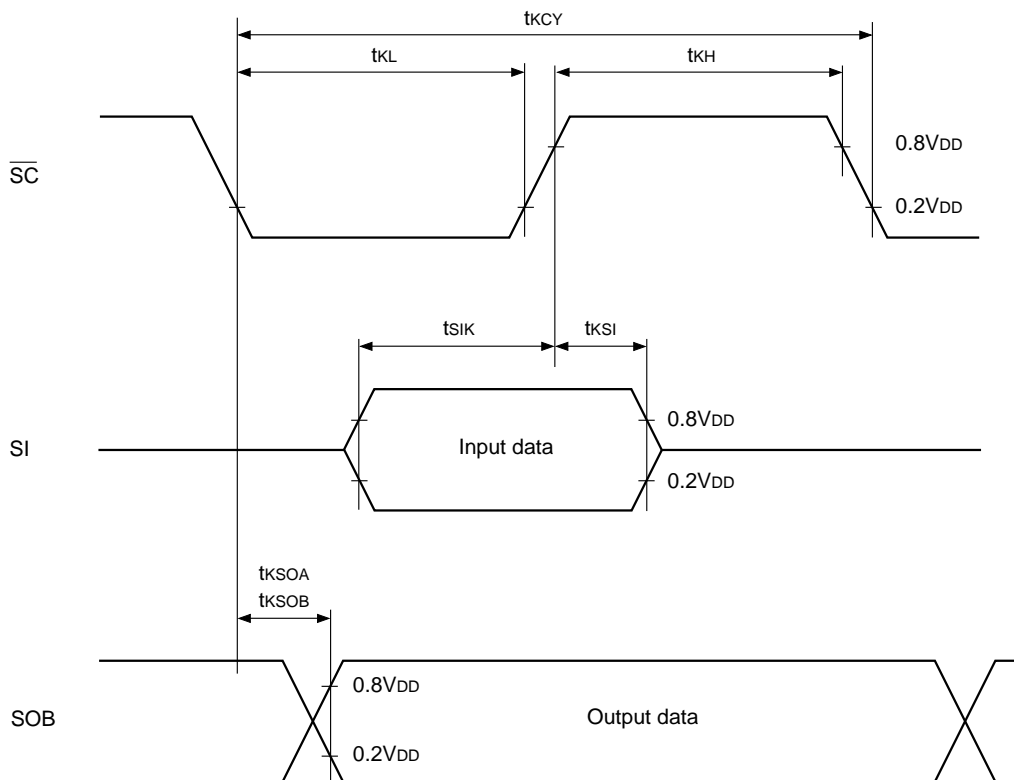

Fig. 4. Serial transfer timing

(3) Others

( $T_a = -20$  to  $+75^\circ\text{C}$ ,  $V_{DD} = 3.5$  to  $5.5\text{V}$ ,  $V_{SS} = 0\text{V}$ )

Item	Symbol	Pin	Conditions	Min.	Max.	Unit
External interruption high, low level width	$t_{1H}$ , $t_{1L}$	INT1	Edge detection mode	$t_{sys} + 0.05$		$\mu\text{s}$
Reset input low level width	$t_{RSL}$	$\overline{\text{RST}}$		$2t_{sys}$		$\mu\text{s}$

Note)  $t_{sys} = 8/f_c$

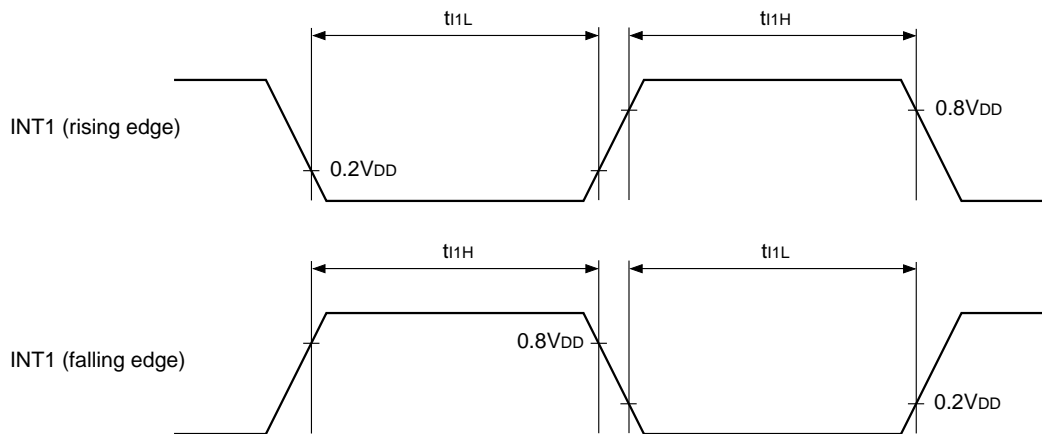

Fig. 5. Interruption input timing

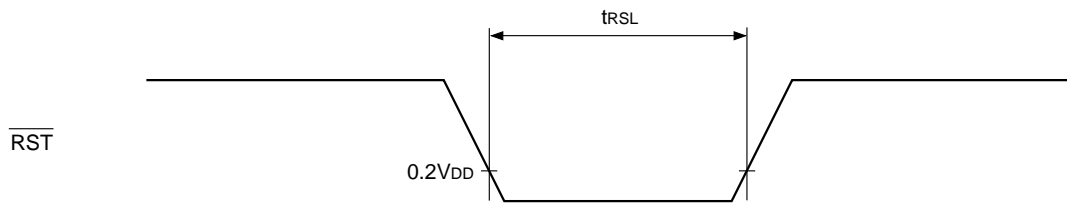
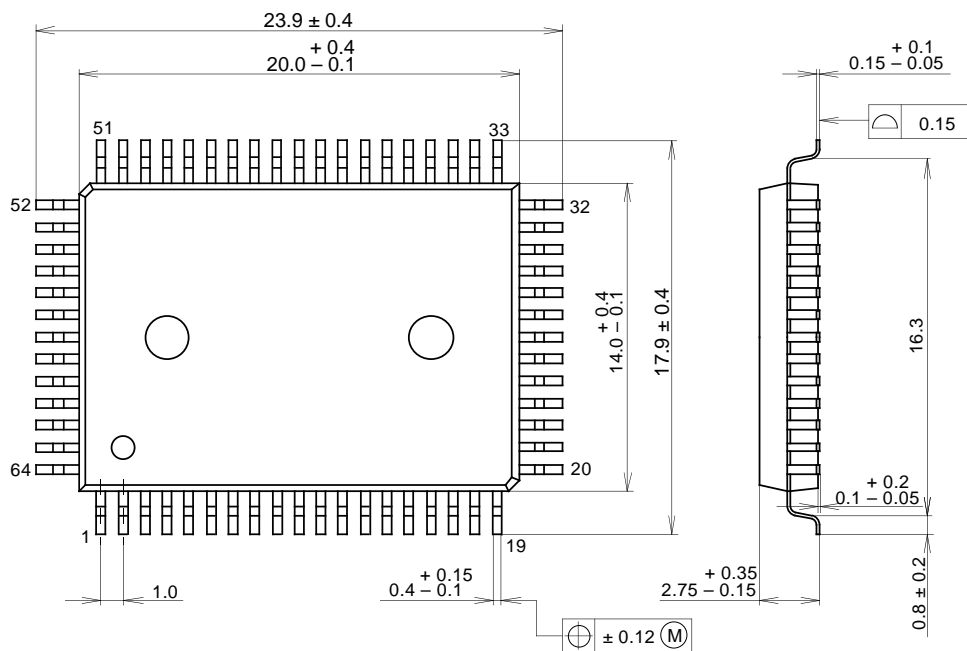

Fig. 6.  $\overline{\text{RST}}$  input timing

Package Outline Unit: mm

64PIN QFP(PLASTIC)



SONY CODE	QFP-64P-L01
EIAJ CODE	*QFP064-P-1420
JEDEC CODE	_____

PACKAGE STRUCTURE

PACKAGE MATERIAL	EPOXY RESIN
LEAD TREATMENT	SOLDER/PALLADIUM PLATING
LEAD MATERIAL	COPPER /42 ALLOY
PACKAGE WEIGHT	1.5g