

NCE N-Channel Enhancement Mode Power MOSFET

General Description

The NCE7559k uses advanced trench technology and design to provide excellent $R_{DS(ON)}$ with low gate charge. This device is suitable for use in PWM, load switching and general purpose applications.

Features

- $V_{DS}=75V$; $I_D=59A@V_{GS}=10V$;
 $R_{DS(ON)}<8.5m\Omega @V_{GS}=10V$
- Special process technology for high ESD capability
- Special designed for Convertors and power controls
- High density cell design for ultra low R_{dson}
- Fully characterized Avalanche voltage and current
- Good stability and uniformity with high E_{AS}
- Excellent package for good heat dissipation

Application

- Power switching application
- Hard Switched and High Frequency Circuits
- Uninterruptible Power Supply

Product Summary

BV_{DSS}	typ.	84	V
$R_{DS(ON)}$	typ.	7.2	m Ω
	max.	8.5	m Ω
I_D		59	A

100% UIS TESTED!

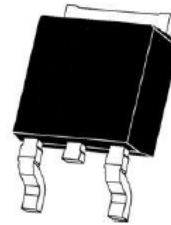

TO-252-2L top view

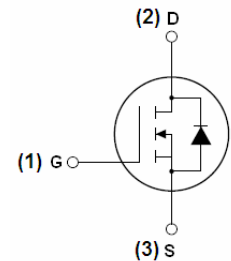

Schematic diagram

Package Marking and Ordering Information

Device Marking	Device	Device Package	Reel Size	Tape width	Quantity
NCE7559K	NCE7559K	TO-252-2L	-	-	-

Table 1. Absolute Maximum Ratings ($T_C=25^\circ C$)

Parameter	Symbol	Value	Unit
Drain-Source Voltage ($V_{GS}=0V$)	V_{DS}	75	V
Gate-Source Voltage ($V_{DS}=0V$)	V_{GS}	± 20	V
Drain Current (DC) at $T_C=25^\circ C$	$I_{D(DC)}$	59	A
Drain Current (DC) at $T_C=100^\circ C$	$I_{D(DC)}$	41	A
Drain Current-Continuous@ Current-Pulsed (Note 1)	$I_{DM(pluse)}$	230	A
Maximum Power Dissipation($T_C=25^\circ C$)	P_D	130	W
Derating factor		0.87	W/ $^\circ C$
Single pulse avalanche energy (Note 2)	E_{AS}	550	mJ
Operating Junction and Storage Temperature Range	T_J, T_{STG}	-55 To 175	$^\circ C$

Notes 1.Repetitive Rating: Pulse width limited by maximum junction temperature

2.EAS condition : $T_J=25^\circ C, V_{DD}=37.5V, V_G=10V, L=0.5mH$

Table 2. Thermal Characteristic

Parameter	Symbol	Value	Unit
Thermal Resistance, Junction-to-Case (Maximum)	R_{thJC}	1.15	$^{\circ}C/W$
Thermal Resistance, Junction-to-Ambient (Maximum)	R_{thJA}	63	$^{\circ}C/W$

Table 3. Electrical Characteristics ($T_C=25^{\circ}C$ unless otherwise noted)

Parameter	Symbol	Condition	Min	Typ	Max	Unit
On/off states						
Drain-Source Breakdown Voltage	BV_{DSS}	$V_{GS}=0V, I_D=250\mu A$	75	84	-	V
Zero Gate Voltage Drain Current($T_C=25^{\circ}C$)	I_{DSS}	$V_{DS}=75V, V_{GS}=0V$	-	-	1	μA
Zero Gate Voltage Drain Current($T_C=125^{\circ}C$)	I_{DSS}	$V_{DS}=75V, V_{GS}=0V$	-	-	10	μA
Gate-Body Leakage Current	I_{GSS}	$V_{GS}=\pm 20V, V_{DS}=0V$	-	-	± 100	nA
Gate Threshold Voltage	$V_{GS(th)}$	$V_{DS}=V_{GS}, I_D=250\mu A$	2	2.85	4	V
Drain-Source On-State Resistance	$R_{DS(on)}$	$V_{GS}=10V, I_D=30A$	-	7.2	8.5	m Ω
Dynamic Characteristics						
Forward Transconductance	g_{FS}	$V_{DS}=5V, I_D=30A$	-	60	-	S
Input Capacitance	C_{iss}	$V_{DS}=25V, V_{GS}=0V,$ $F=1.0MHz$	-	3400	-	PF
Output Capacitance	C_{oss}		-	290	-	PF
Reverse Transfer Capacitance	C_{rss}		-	221	-	PF
Total Gate Charge	Q_g	$V_{DS}=30V, I_D=30A,$ $V_{GS}=10V$	-	94	-	nC
Gate-Source Charge	Q_{gs}		-	16	-	nC
Gate-Drain Charge	Q_{gd}		-	24	-	nC
Switching times						
Turn-on Delay Time	$t_{d(on)}$	$V_{DD}=30V, I_D=2A, R_L=15\Omega$ $V_{GS}=10V, R_G=2.5\Omega$	-	15	-	nS
Turn-on Rise Time	t_r		-	11	-	nS
Turn-Off Delay Time	$t_{d(off)}$		-	52	-	nS
Turn-Off Fall Time	t_f		-	13	-	nS
Source- Drain Diode Characteristics						
Source-drain current(Body Diode)	I_{SD}		-	-	59	A
Forward on voltage ^(Note 1)	V_{SD}	$T_j=25^{\circ}C, I_{SD}=40A, V_{GS}=0V$	-	-	1.2	V
Reverse Recovery Time ^(Note 1)	t_{rr}	$T_j=25^{\circ}C, I_F=40A, di/dt=100A/\mu s$	-	-	33	nS
Reverse Recovery Charge ^(Note 1)	Q_{rr}		-	-	54	nC
Forward Turn-on Time	t_{on}	Intrinsic turn-on time is negligible(turn-on is dominated by L_S+L_D)				

Notes

1. Pulse Test: Pulse Width $\leq 300\mu s$, Duty Cycle $\leq 1.5\%$, $R_G=25\Omega$, Starting $T_j=25^{\circ}C$

Test circuit

1) E_{AS} test circuit

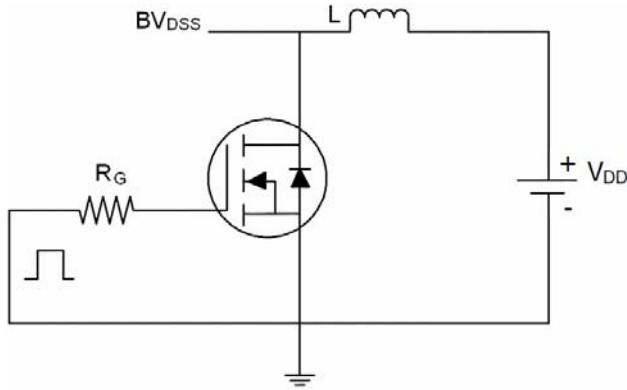

2) Gate charge test circuit

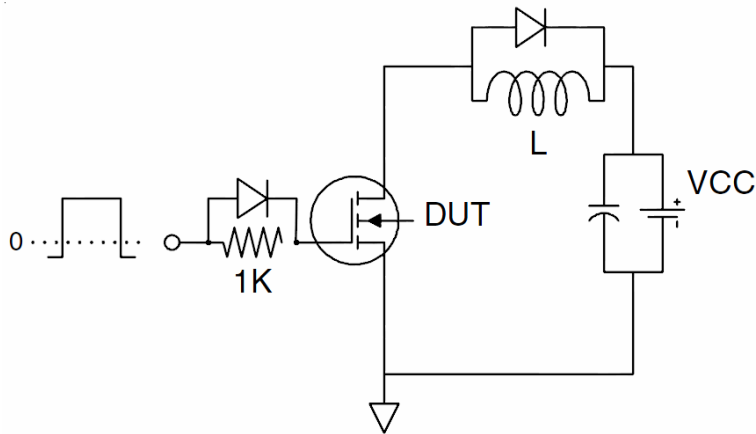

3) Switch Time Test Circuit

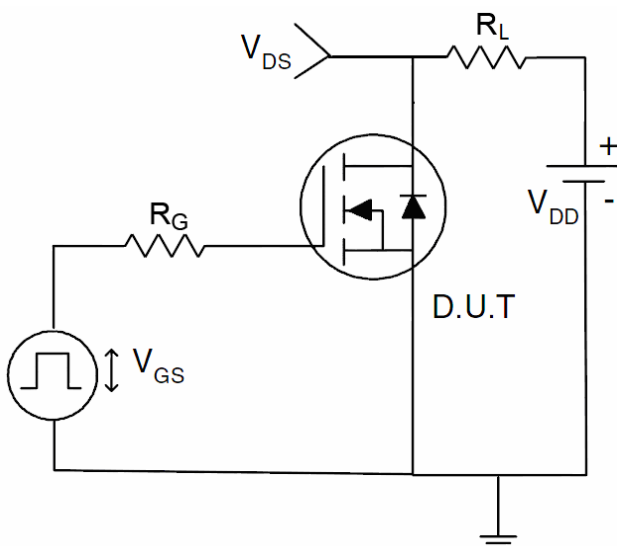

Typical Electrical and Thermal Characteristics (curves)

Figure1. Safe operating area

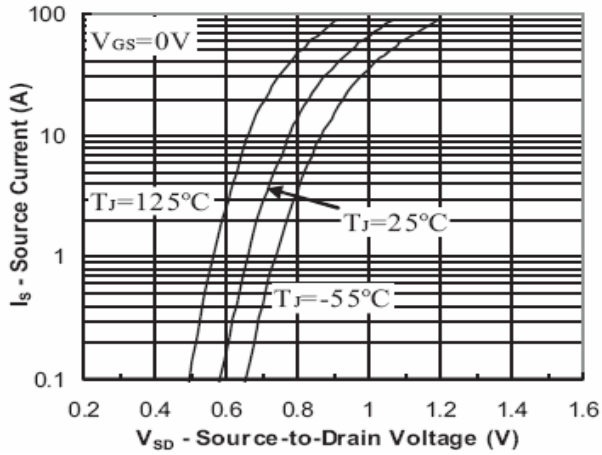

Figure2. Source-Drain Diode Forward Voltage

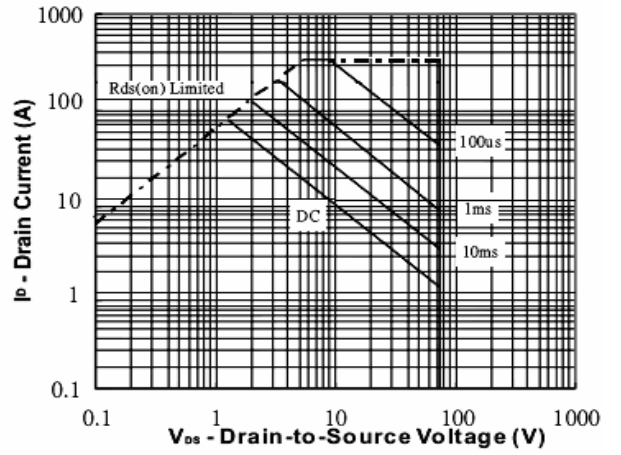

Figure3. Output characteristics

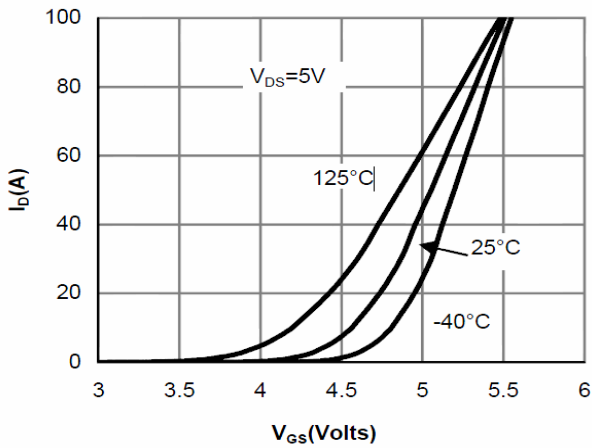

Figure4. Transfer characteristics

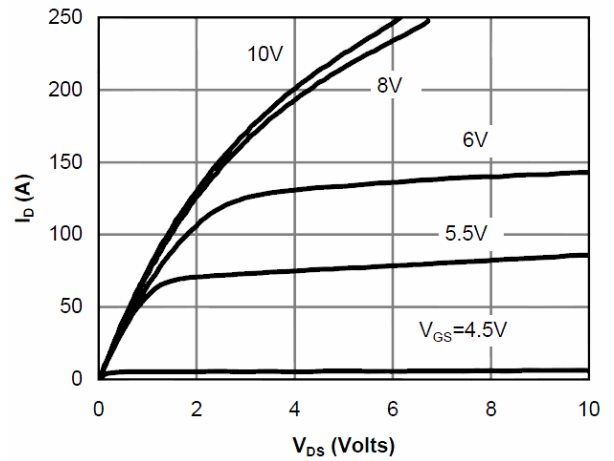

Figure5. Static drain-source on resistance

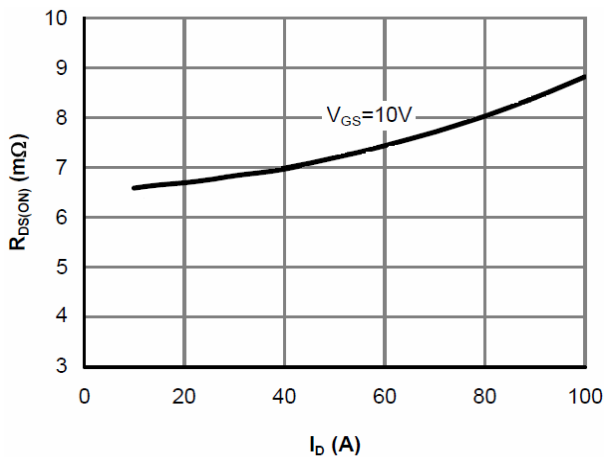

Figure6. $R_{DS(ON)}$ vs Junction Temperature

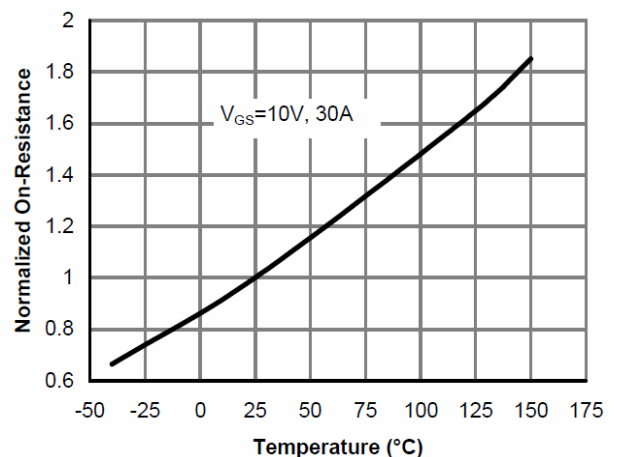

Figure7. BV_{DSS} vs Junction Temperature

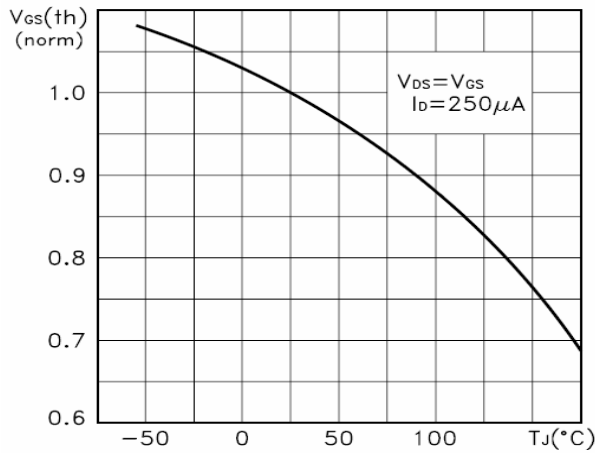

Figure8. $V_{GS(th)}$ vs Junction Temperature

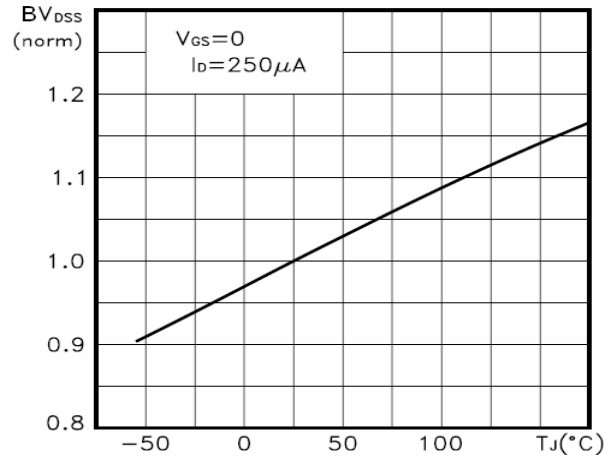

Figure9. Capacitance

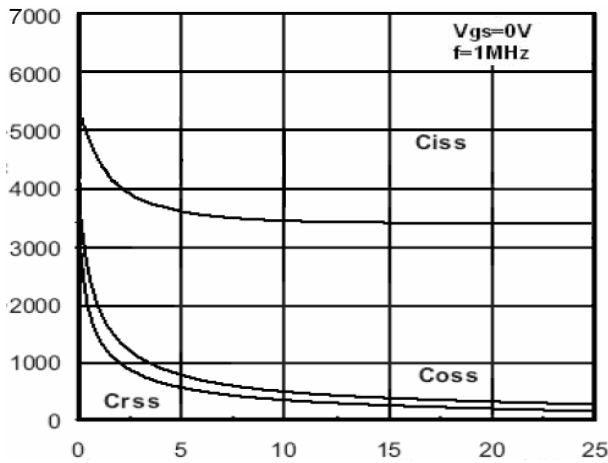

Figure10. Gate charge waveforms

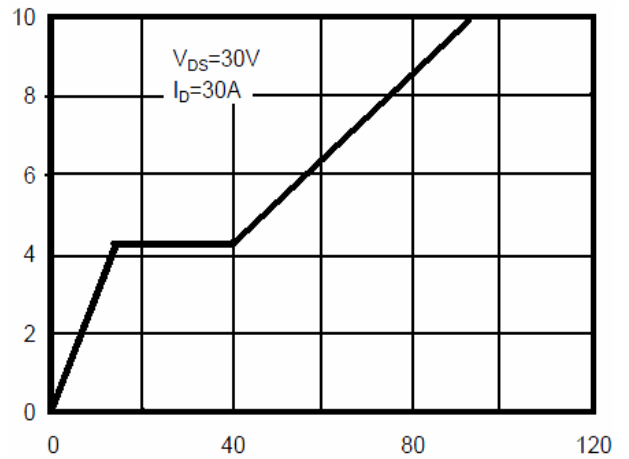
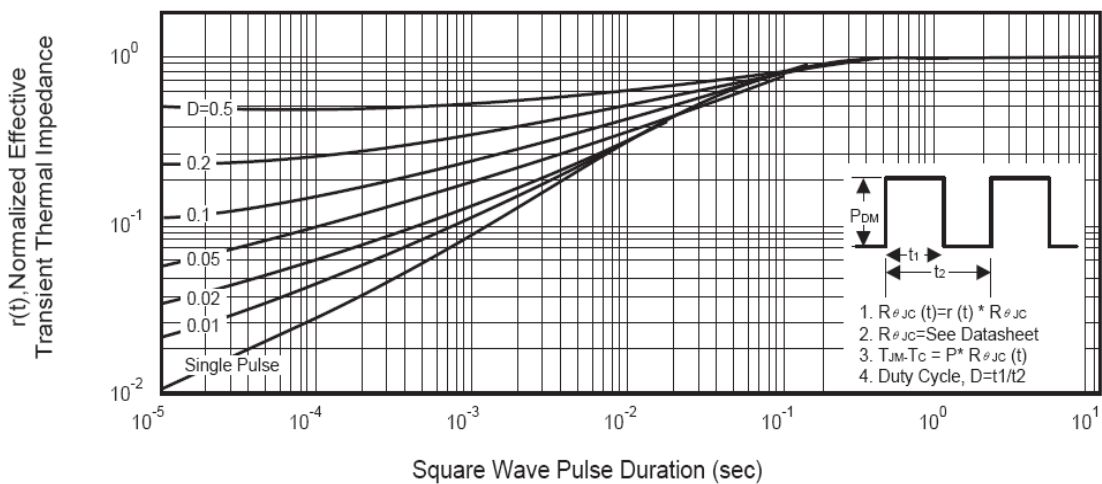
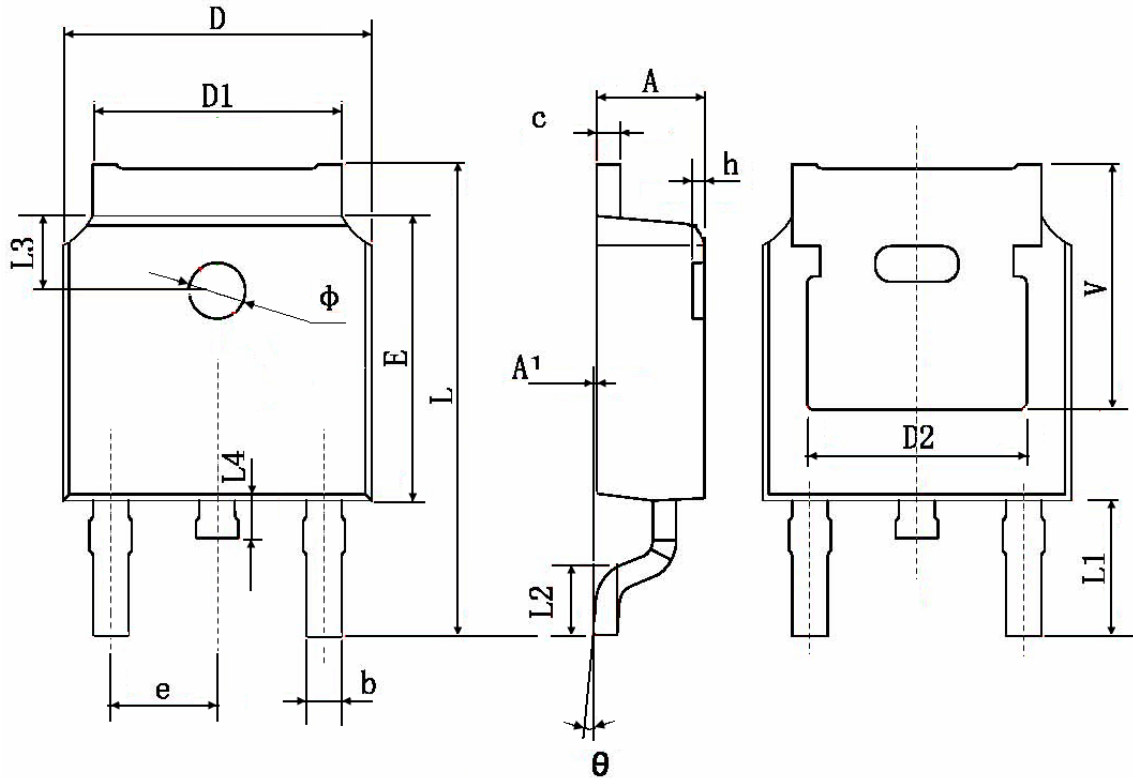

Figure11. Normalized Maximum Transient Thermal Impedance



TO-252 Package Information

Symbol	Dimensions In Millimeters		Dimensions In Inches	
	Min.	Max.	Min.	Max.
A	2.200	2.400	0.087	0.094
A1	0.000	0.127	0.000	0.005
b	0.660	0.860	0.026	0.034
c	0.460	0.580	0.018	0.023
D	6.500	6.700	0.256	0.264
D1	5.100	5.460	0.201	0.215
D2	4.830 TYP.		0.190 TYP.	
E	6.000	6.200	0.236	0.244
e	2.186	2.386	0.086	0.094
L	9.800	10.400	0.386	0.409
L1	2.900 TYP.		0.114 TYP.	
L2	1.400	1.700	0.055	0.067
L3	1.600 TYP.		0.063 TYP.	
L4	0.600	1.000	0.024	0.039
phi	1.100	1.300	0.043	0.051
theta	0°	8°	0°	8°
h	0.000	0.300	0.000	0.012
V	5.350 TYP.		0.211 TYP.	

Attention:

- Any and all NCE products described or contained herein do not have specifications that can handle applications that require extremely high levels of reliability, such as life-support systems, aircraft's control systems, or other applications whose failure can be reasonably expected to result in serious physical and/or material damage. Consult with your NCE representative nearest you before using any NCE products described or contained herein in such applications.
- NCE assumes no responsibility for equipment failures that result from using products at values that exceed, even momentarily, rated values (such as maximum ratings, operating condition ranges, or other parameters) listed in products specifications of any and all NCE products described or contained herein.
- Specifications of any and all NCE products described or contained herein stipulate the performance, characteristics, and functions of the described products in the independent state, and are not guarantees of the performance, characteristics, and functions of the described products as mounted in the customer's products or equipment. To verify symptoms and states that cannot be evaluated in an independent device, the customer should always evaluate and test devices mounted in the customer's products or equipment.
- NCE Power Semiconductor CO.,LTD. strives to supply high-quality high-reliability products. However, any and all semiconductor products fail with some probability. It is possible that these probabilistic failures could give rise to accidents or events that could endanger human lives, that could give rise to smoke or fire, or that could cause damage to other property. When designing equipment, adopt safety measures so that these kinds of accidents or events cannot occur. Such measures include but are not limited to protective circuits and error prevention circuits for safe design, redundant design, and structural design.
- In the event that any or all NCE products(including technical data, services) described or contained herein are controlled under any of applicable local export control laws and regulations, such products must not be exported without obtaining the export license from the authorities concerned in accordance with the above law.
- No part of this publication may be reproduced or transmitted in any form or by any means, electronic or mechanical, including photocopying and recording, or any information storage or retrieval system, or otherwise, without the prior written permission of NCE Power Semiconductor CO.,LTD.
- Information (including circuit diagrams and circuit parameters) herein is for example only ; it is not guaranteed for volume production. NCE believes information herein is accurate and reliable, but no guarantees are made or implied regarding its use or any infringements of intellectual property rights or other rights of third parties.
- Any and all information described or contained herein are subject to change without notice due to product/technology improvement, etc. When designing equipment, refer to the "Delivery Specification" for the NCE product that you intend to use.
- This catalog provides information as of Mar. 2010. Specifications and information herein are subject to change without notice.