

# RFFM6403

2.5V to 4.2V, ISM Band, 1W, 405MHz to 475MHz Transmit/Receive Module

The RFFM6403 is a single-chip front end module (FEM) for applications in the 405MHz and 475MHz ISM Bands. The RFFM6403 addresses the need for aggressive size reduction for typical portable equipment RF front-end design and greatly reduces the number of components outside of the core chipset thus minimizing the footprint and assembly cost of the overall solution. The RFFM6403 contains an integrated 1 Watt PA, SP2T Antenna switch, integrated Tx harmonic filter, LNA with bypass mode, and matching components. The RFFM6403 is packaged in a 28-pin, 6.0mm x 6.0mm x 0.975mm over-molded laminate package with backside ground which greatly minimizes next level board space and allows for simplified integration.



Package: LGA, 28-pin, 6.0mm x 6.0mm x 0.975mm

## Features

- Integrated 50Ω Input/Output Match
- Tx Output Power: 30dBm
- Separate Tx/Rx 50 Ω transceiver interface
- Integrated PA, filtering LNA with Bypass Mode
- Transmit Thru path

## Applications

- 400MHz ISM Bands
- Single Chip RF Front End Module
- Wireless Automatic Metering
- Portable Battery Powered Equipment
- Smart Energy

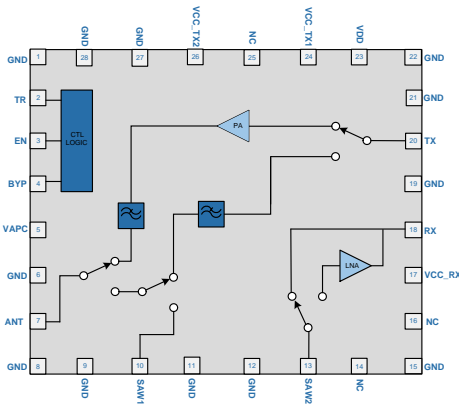

Functional Block Diagram

## Ordering Information

RFFM6403SB	5-piece bag
RFFM6403SQ	25-piece bag
RFFM6403SR	Standard 100-piece reel
RFFM6403TR13	Standard 2500-piece reel
RFFM6403PCK-410	Fully assembled eval board w/5-piece sample bag

## Absolute Maximum Ratings

Parameter	Rating	Unit
Voltage	5.25	V
Storage Temperature Range	-40 to +150	°C
Operating Temperature Range	-40 to +85	°C
Receive RF Input Power (SAW2)	+25	dBm
Transmit RF Input Power (PA Enabled)	+15	dBm
Transmit RF Input Power (PA Bypass)	+20	dBm
Receive RF Input Power (ANT)	+33	dBm
T/R Port Load VSWR in Transmit Mode	10:1	
ESD, HBM	350	V
ESD, CDM	300	V
Moisture Sensitivity Level	MSL3	



**Caution!** ESD sensitive device.



RFMD Green: RoHS status based on EU Directive 2011/65/EU (at time of this document revision), halogen free per IEC 61249-2-21, < 1000ppm each of antimony trioxide in polymeric materials and red phosphorus as a flame retardant, and <2% antimony in solder.

Exceeding any one or a combination of the Absolute Maximum Rating conditions may cause permanent damage to the device. Extended application of Absolute Maximum Rating conditions to the device may reduce device reliability. Specified typical performance or functional operation of the device under Absolute Maximum Rating conditions is not implied.

## Nominal Operating Parameters

Parameter	Specification			Unit	Condition
	Min	Typ	Max		
Frequency	405	440	475	MHz	
RF Port Impedance		50		$\Omega$	
Operating Voltage	2.5	3.6	4.2	V	
<b>Leakage Current</b>					<b><math>V_{CC\text{Tx}1} = 3.6\text{V}</math>, <math>V_{CC\text{Tx}2} = 3.6\text{V}</math>, <math>V_{DD} = 3.6\text{V}</math>, <math>V_{CC\text{Rx}} = 3.6\text{V}</math>, <math>V_{APC} = 0.0\text{V}</math>, <math>EN = 0.0\text{V}</math>, <math>TR = 0.0\text{V}</math>, <math>BYP} = 0.0\text{V}</math>, <math>RF = \text{Off}</math>, <math>\text{Temperature} = 25^\circ\text{C}</math></b>
$V_{DD}$		0.05	0.1	$\mu\text{A}$	
$V_{CC\text{ TX}}$		0.05	0.1	$\mu\text{A}$	
$V_{CC\text{ RX}}$		0.05	0.1	$\mu\text{A}$	
<b>Operating Voltages</b>					
$V_{CC\text{ TX}1/2}$	2.5	3.6	4.2	V	
$V_{CC\text{ RX}}$	2.5	3.3	4.2	V	
$V_{DD}$	2.5	3.6	4.2	V	
Tx Output Power Control ( $V_{APC}$ )	0.00	2.25	2.50	V	$V_{APC}$ operates such that the transmitter output power is saturated at a level lower than 1.9V and minimal variation in output power of the device occurs above that level

Parameter	Specification			Unit	Condition
	Min	Typ	Max		
<b>Transmit High Power Mode</b>					<b><math>V_{CC}Tx1 = 3.6V, V_{CC}Tx2 = 3.6V, V_{DD} = 3.6V, V_{CC}Rx = 0.0V,</math> <math>V_{APC} = 2.25V, EN = 1.8V, T_R = 1.8V, BYP = 0.2V,</math> Measured Path=TX to ANT, Temperature = 25°C</b>
Output Power	30.0	30.5		dBm	$V_{CC}Tx1, V_{CC}Tx2 = 3.6V, P_{IN} = +10dBm$
		28.5		dBm	$V_{CC}Tx1, V_{CC}Tx2 = 2.7V, P_{IN} = +10dBm$
Output P3dB		30.5		dBm	$V_{CC}Tx1, V_{CC}Tx2 = 3.6V$
Input Return Loss	13			dB	
Output Return Loss Small Signal		7.5		dB	
Operating Current	1000	1250	1400	mA	$P_{OUT} = 30.5dBm, I_{CC} TX1 + I_{CC} TX2$
Quiescent Current		120		mA	$I_{CC} TX1 + I_{CC} TX2, RF = Off$
$I_{DD}$		14			$P_{OUT} = 31.0dBm$
Second Harmonic			-65	dBc	$P_{OUT} = 30.5dBm, F_0 = 405MHz$
			-67	dBc	$P_{OUT} = 30.5dBm, F_0 = 413MHz \text{ to } 475MHz$
Third - Tenth Harmonic			-70	dBc	$P_{OUT} = 30.5dBm$
Gain	20.0	20.5		dB	$V_{CC}Tx1, V_{CC}Tx2 = 3.6V, P_{IN} = +10dBm$
		18.5		dB	$V_{CC}Tx1, V_{CC}Tx2 = 2.7V, P_{IN} = +10dBm$
Output Power Variation	-0.4		-0.4	dB	Over frequencies and voltage
Module PAE		25		%	$V_{CC}Tx1, V_{CC}Tx2 = 3.6V, P_{OUT} = 30dBm$ (takes into account filter and switches)
PA PAE		54		%	$V_{CC}Tx1, V_{CC}Tx2 = 3.6V, P_{OUT} = 30dBm$ (Excludes losses of module filter and switches)
<b>Transmit Bypass Mode</b>					<b><math>V_{CC}Tx1 = 3.6V, V_{CC}Tx2 = 3.6V, V_{DD} = 3.6V, V_{CC}Rx = 0.0V,</math> <math>V_{APC} = 0.0V, EN = 1.8V, T_R = 1.8V, BYP = 1.8V,</math> Measured Path=TX to ANT, Temperature = 25°C</b>
Insertion Loss		2.5	3.0	dB	
Input P1dB	26	30		dBm	
Input IP3	43	45		dBm	
Input Return Loss	15			dB	
Output Return Loss	15			dB	
Second Harmonic Attenuation	30			dB	Second Harmonic Insertion Loss
Third - Tenth Harmonic Attenuation	50			dB	Third-Tenth Harmonic Insertion Loss
<b>Receive Mode</b>					<b><math>V_{CC}Tx1 = 3.3V, V_{CC}Tx2 = 3.3V, V_{DD} = 3.3V, V_{CC}Rx = 3.3V,</math> <math>V_{APC} = 0.0V, EN = 1.8V, T_R = 0.2V, BYP = 0.2V,</math> Measured Path = SAW2 to RX, Temperature = 25°C</b>
IP1dB	-12	-6		dBm	
Gain	14	15	16	dB	
Operating Current	4	5	7	mA	
$I_{DD}$		1		mA	
Noise Figure		1.9	2.7	dB	
IIP3	1	3	5	dBm	
Input Return Loss	10			dB	
Output Return Loss	10			dB	

Parameter	Specification			Unit	Condition
	Min	Typ	Max		
<b>Receive Bypass Mode</b>					<b><math>V_{CC}Tx1 = 3.3V, V_{CC}Tx2 = 3.3V, V_{DD} = 3.3V, V_{CC}Rx = 3.3V,</math> <math>V_{APC} = 0.0V, EN = 1.8V, T_R = 0.2V, BYP = 1.8V,</math> Measured Path = SAW2 to RX, Temperature = 25°C</b>
Insertion Loss		2		dB	
$I_{DD}$ Quiescent		200		$\mu A$	
IP1dB		19		dBm	
IIP3	42	44		dBm	
Input Return Loss	7.5			dB	
Output Return Loss	7			dB	
<b>Antenna Switch</b>					<b>Measured ANT to SAW1, RX &amp; RX BYPASS Modes</b>
Insertion Loss		0.5	0.6	dB	
Input Return Loss	15.5	16.0		dB	
Output Return Loss	15.5	16.0		dB	
<b>Isolation</b>					
Isolation	30				ANT to SAW1, module in Transmit Bypass Mode
	50			dB	ANT to SAW1, module in Transmit High Power Mode
<b>Logic</b>					<b>EN, TR, BYP</b>
Control Logic HIGH	1.6		4.0	V	Max Control Logic High = $V_{DD} - 0.2V_{DC}$
Control Logic LOW		0.2	0.3	V	
Control Logic HIGH Current			1.5	$\mu A$	
Control Logic LOW Current		0.1		$\mu A$	
$V_{APC}$ HIGH Current		57		$\mu A$	Across all rated voltages at rated power

### Switch Control Truth Table

Operating Mode	TR	EN	BYP	PA	LNA
	(Pin2)	(Pin3)	(Pin4)		
Transmit	High	High	Low	ON	OFF
Transmit Bypass	High	High	High	OFF	OFF
Receive	Low	High	Low	OFF	ON
Receive Bypass	Low	High	High	OFF	OFF
Shutdown	X	Low	X	OFF	OFF

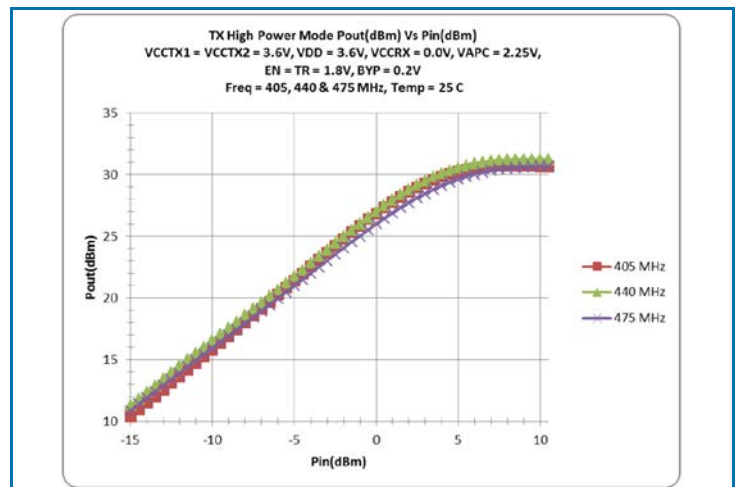
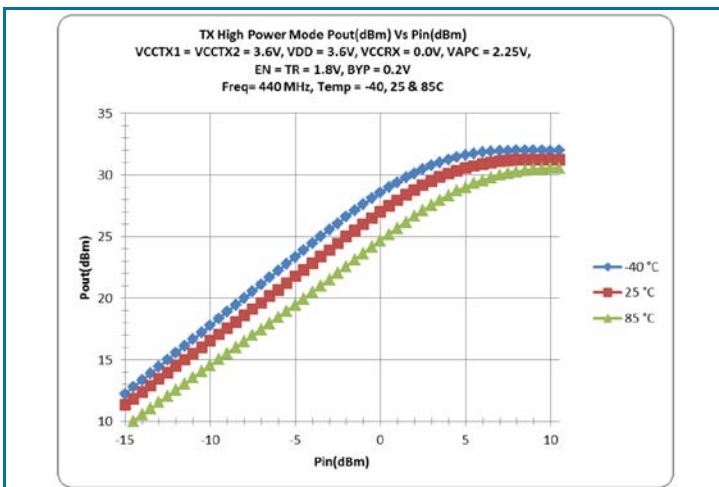
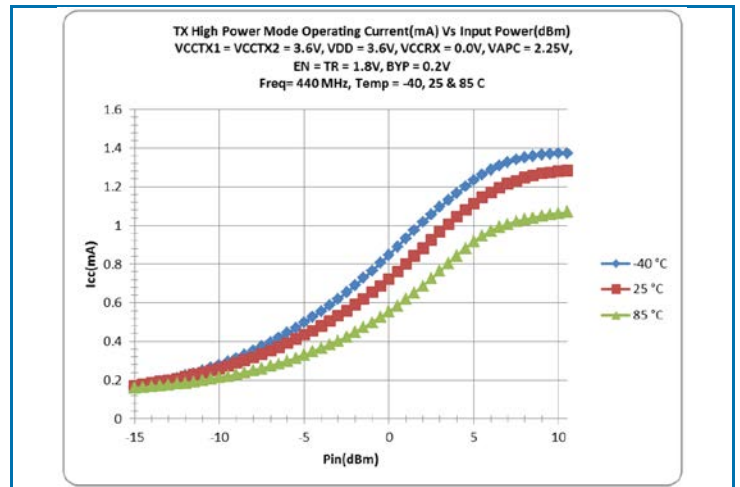
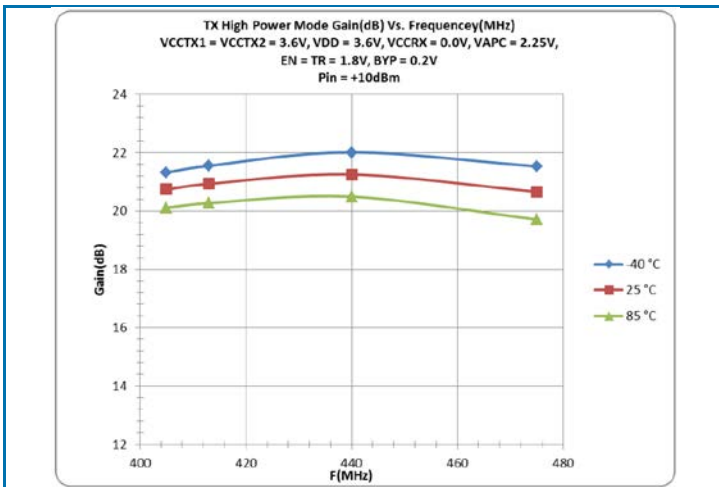
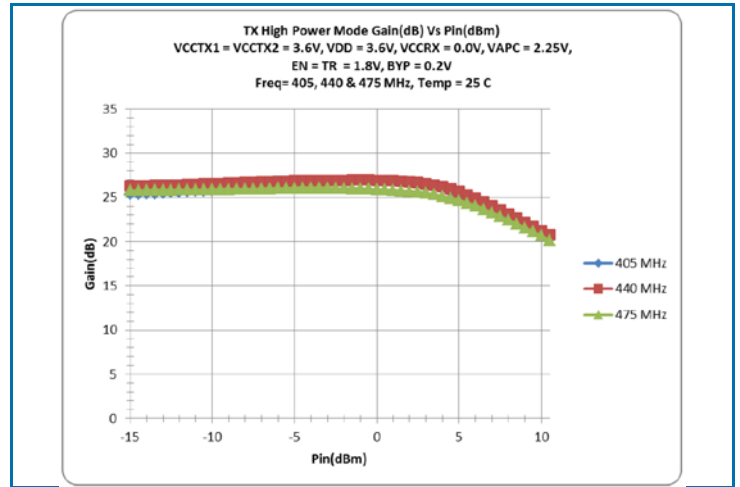
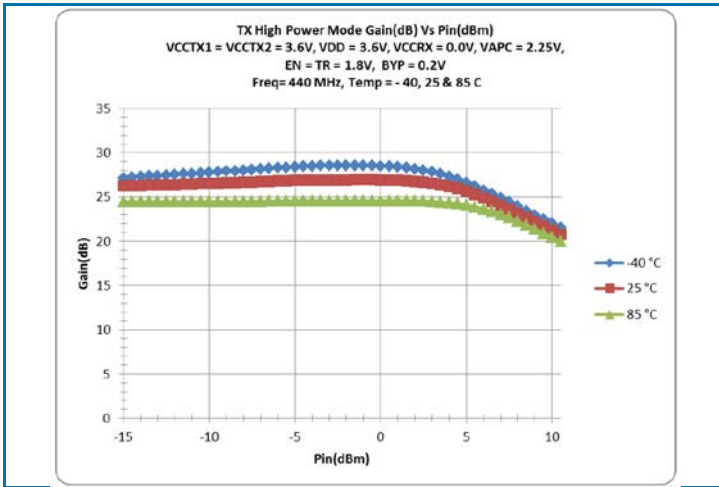

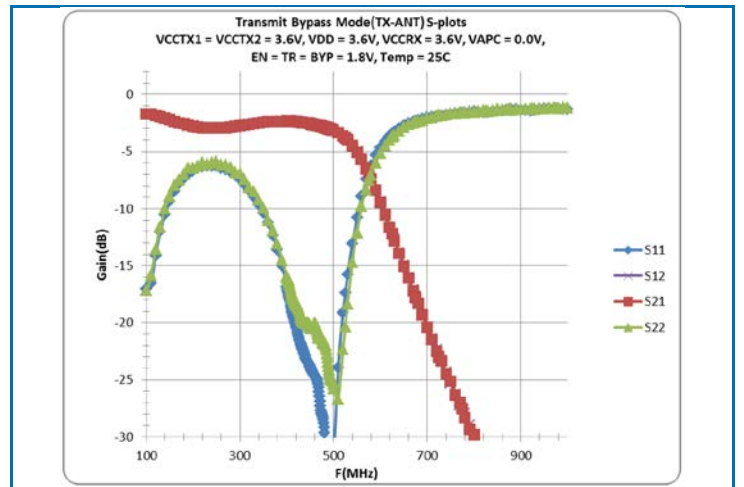
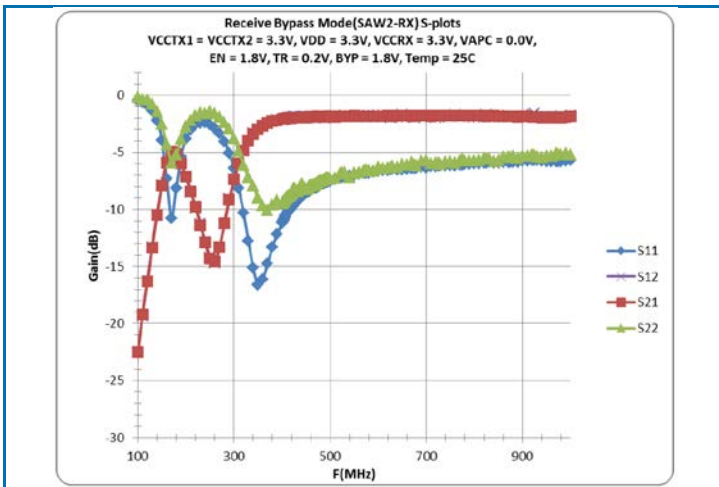
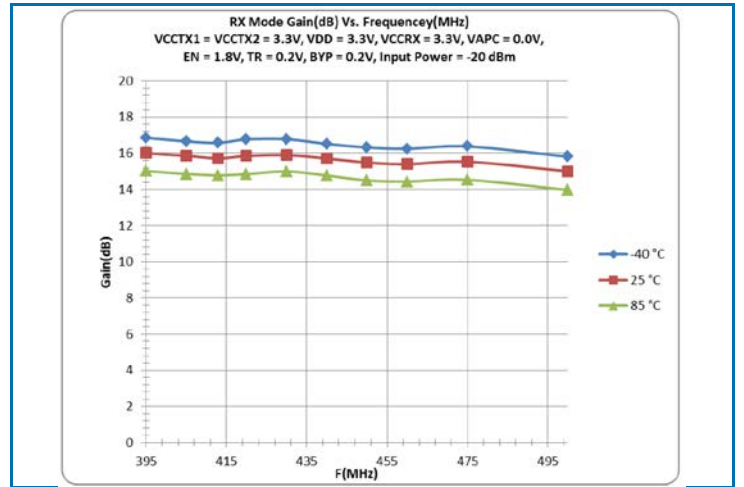
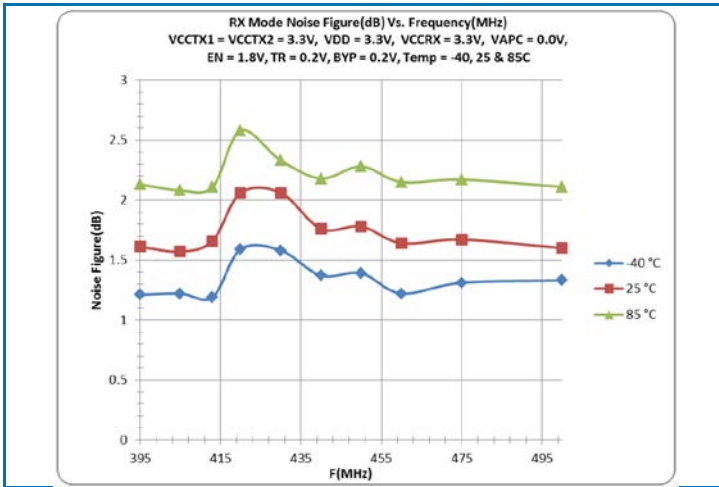

### Application Schematic

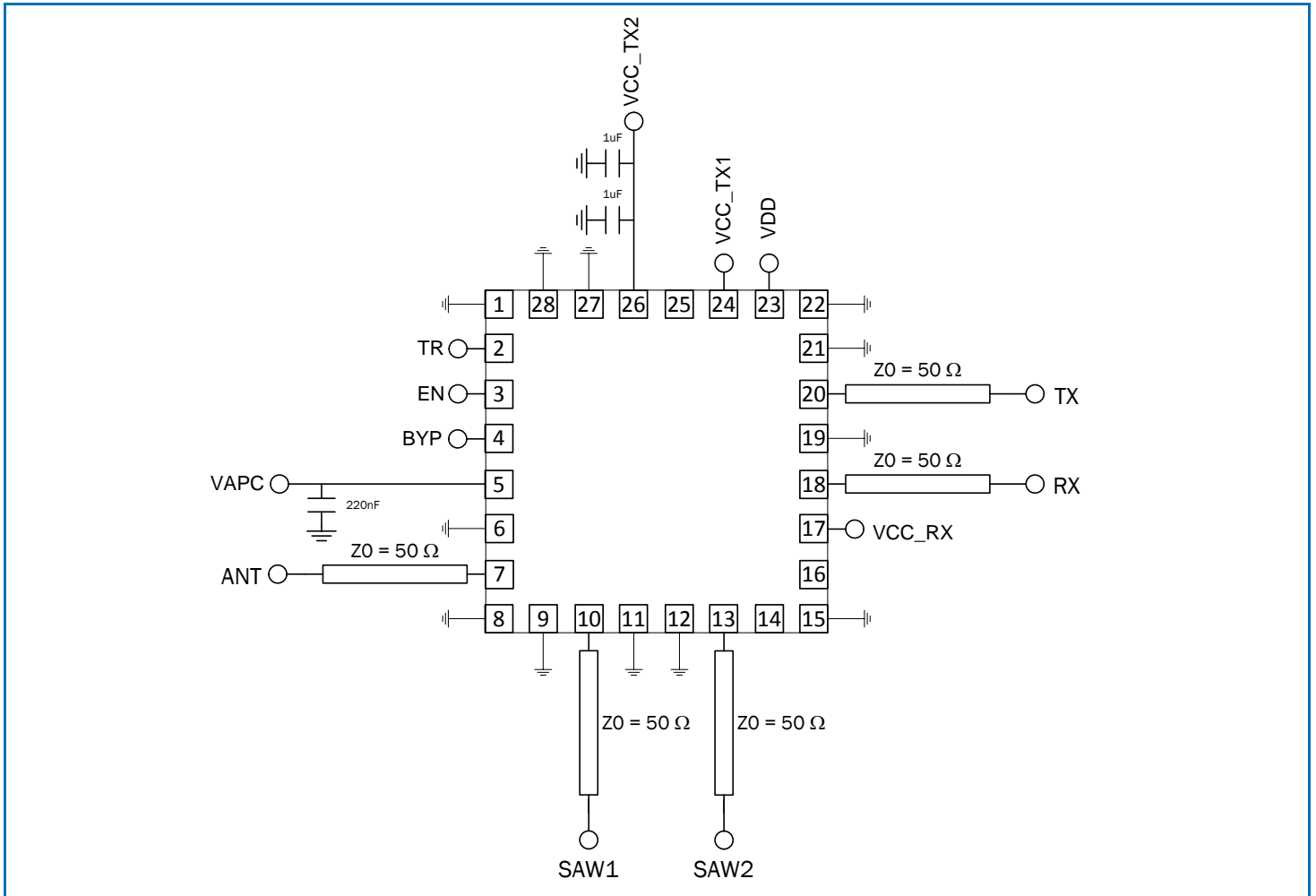

Pin Out

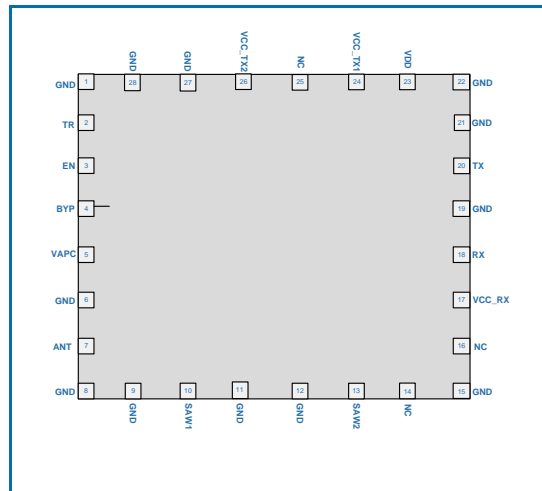

Package Outline and Branding Drawing (Dimensions in millimeters)

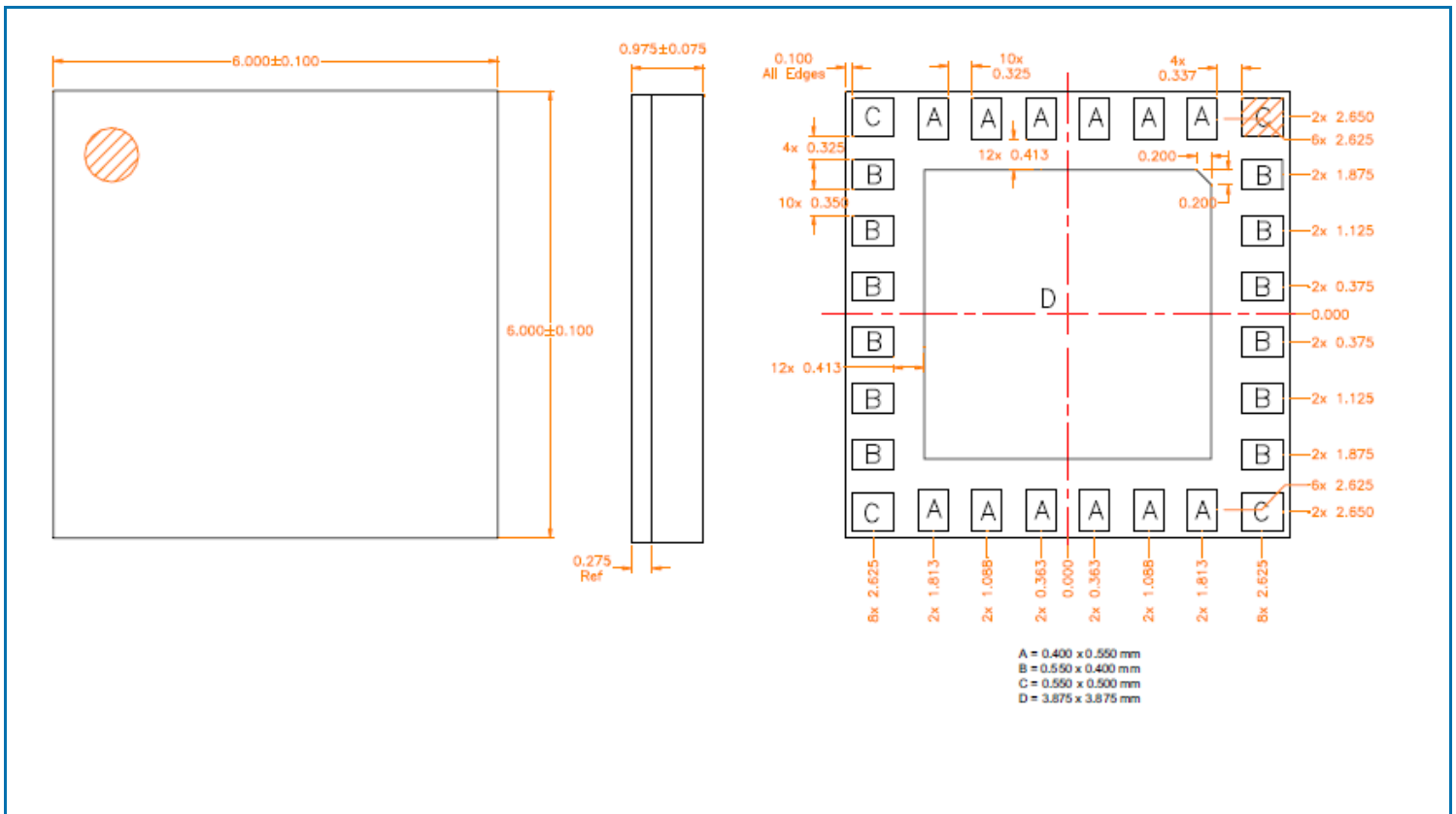



PCB Patterns

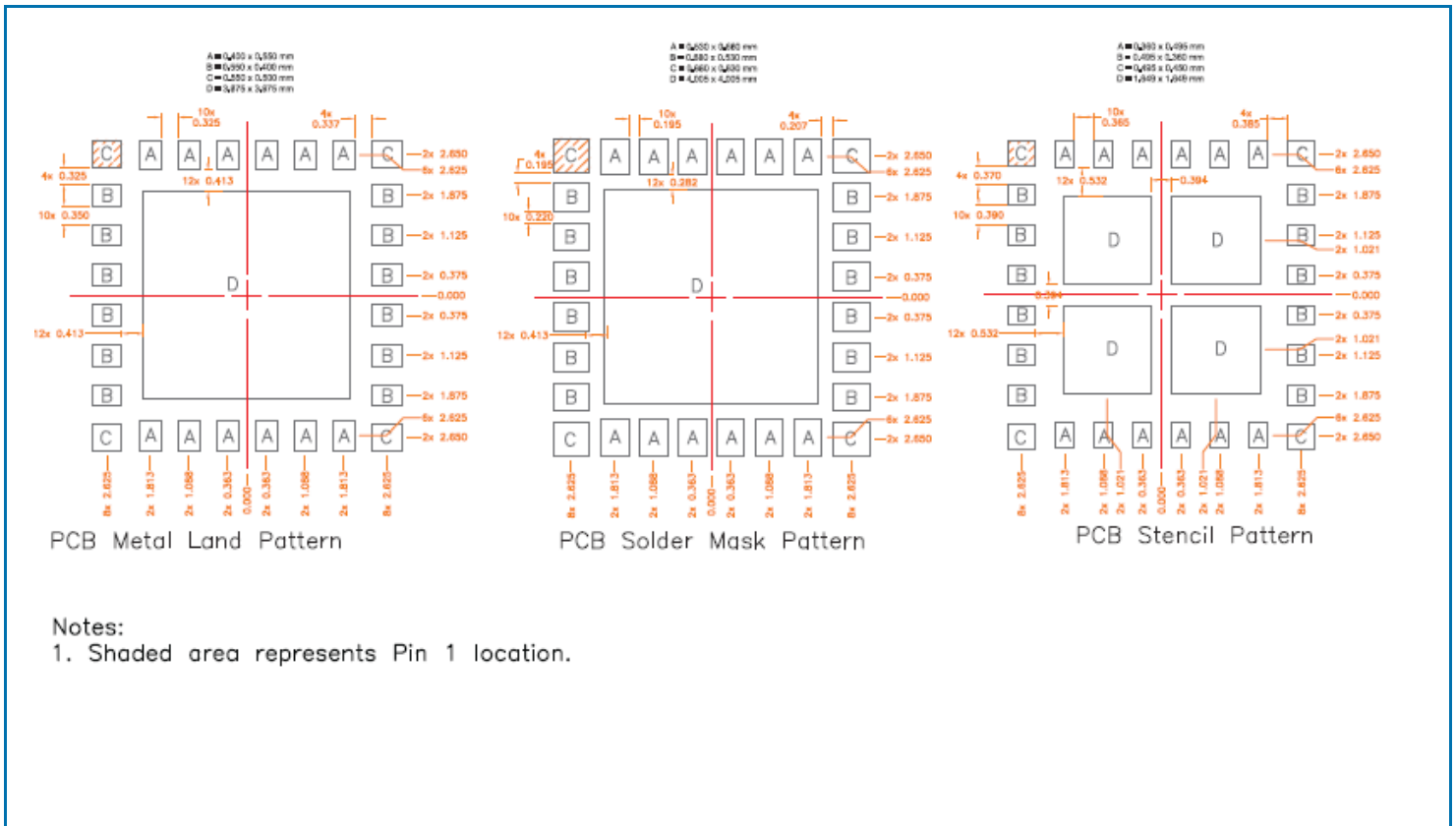

## Pin Names and Descriptions

Pin	Name	Description
1	GND	Ground
2	TR	Digital Input: Transmit/Receive
3	EN	Digital Input: Shutdown Mode
4	BYP	Digital Input: RX Bypass Mode
5	VAPC	Analog Input
6	GND	Ground
7	ANT	Antenna Switch Common Port, internally matched to 50Ω, DC Blocked
8	GND	Ground
9	GND	Ground
10	SAW1	Receive side of antenna switch, internally matched to 50Ω, DC Blocked
11	GND	Ground
12	GND	Ground
13	SAW2	RX and RX bypass input port, internally matched to 50Ω, DC Blocked
14	NC	Not internally connected/open
15	GND	Ground
16	NC	Not internally connected/open
17	VCC_RX	3.3V power supply
18	RX	Receive output, internally matched to 50Ω, DC Blocked
19	GND	Ground
20	TX	TX and TX bypass input port, internally matched to 50Ω, DC Blocked
21	GND	Ground
22	GND	Ground
23	VDD	3.6V power supply
24	VCC_TX1	3.6V power supply
25	NC	Not internally connected/open
26	VCC_TX2	3.6V power supply
27	GND	Ground
28	GND	Ground