

Fast Switching SCR T72H_45

450A Avg.
(700 RMS)
Up to 1400 Volts
25-50 μ s

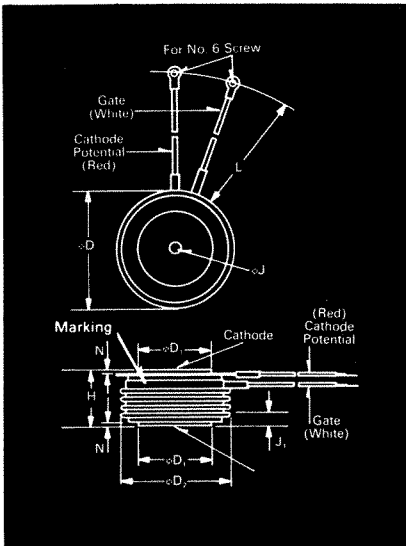

Symbol	Inches		Millimeters	
	Min.	Max.	Min.	Max.
ϕD	2.250	2.290	57.15	58.17
ϕD_1	1.333	1.343	33.86	34.11
ϕD_2	2.030	2.090	51.56	53.09
H	1.020	1.060	25.91	26.92
ϕJ	.135	.145	3.43	3.68
J_1	.075	.090	1.91	2.29
L	7.75	8.50	196.85	215.90
N	.040		1.02	

Creep Distance—1.00 in. min. (25.40 mm).
Strike Distance—.69 in. min. (17.53 mm).
(In accordance with NEMA standards.)
Finish—Nickel Plate.
Approx. Weight—8 oz. (227 g).
1. Dimension "H" is a clamped dimension.

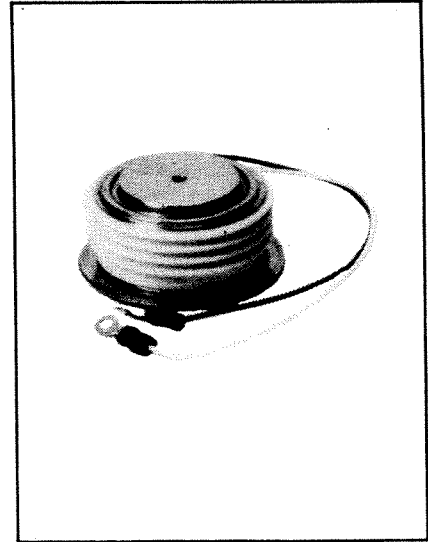

T72 Outline

Features:

- Interdigitated, di/namic Gate structure
- Hard Commutation Turn-Off
- Forward Blocking Capabilities to 1200 Volts
- Low Switching Losses at High Frequency
- Soft Commutation (Feedback Diode) Testing Available
- High di/dt with softgate control

Applications:

- Induction Heating
- Transportation
- Inverters
- Crowbars
- Cycloconverters

Ordering Information

Type	Voltage		Current		Turn-off		Gate current		Leads		
	Code	V _{DRM} and V _{RRM} (V)	Code	I _{T(av)} (A)	Code	t _q μ sec	Code	I _{GT} (ma)	Code	Case	
T72H		100	01	450	45	25	B	150	4	T72	DN
		200	02								
		300	03								
		400	04								
		500	05								
		600	06								
		700	07								
		800	08								
		900	09								
		1000	10								
		1100	11								
		1200	12								
		1400	14								

Example

Obtain optimum device performance for your application by selecting proper Order Code.

Type T72H rated at 450 A average with V_{DRM} = 1000V, I_{GT} = 150 ma, t_q = 40 μ sec max. and leads—order as:

Type	Voltage	Current	Turn Off	Gate Current	Leads
T 7 2 H	1 0	4 5	4	4	D N

**450A Avg.
(700 RMS)
Up to 1400 Volts
25-50 μ s**

**Fast Switching
SCR
T72H_45**

Voltage ①

Blocking State Maximums ($T_J = 125^\circ\text{C}$)

Repetitive peak forward blocking voltage, V	V_{DRM}
Repetitive peak reverse voltage, V	V_{RRM}
Non-repetitive transient peak reverse voltage, $t \leq 5.0$ msec, V	V_{RSM}
Forward leakage current, mA peak	I_{DRM}
Reverse leakage current, mA peak	I_{RRM}

100	200	300	400	500	600	700	800	900	1000	1100	1200	1400
100	200	300	400	500	600	700	800	900	1000	1100	1200	1400
200	300	400	500	600	700	800	900	1000	1100	1200	1300	1500

←----- 35 ----->
←----- 35 ----->

Current

Conducting State Maximums
($T_J = 125^\circ\text{C}$)

Symbol	T72H_45
RMS forward current, A	$I_T(\text{rms})$ 700
Ave. forward current, A	$I_T(\text{av})$ 450
One-half cycle surge current ^② , A	I_{TSM} 7500
3 cycle surge current ^③ , A	I_{TSM} 5300
10 cycle surge current ^④ , A	I_{TSM} 4650
I^2t for fusing (for times ≥ 8.3 ms) A ² sec.	I^2t 234,000
Forward voltage drop at $I_{TM} = 1500\text{A}$ and $T_J = 25^\circ\text{C}$, V	V_{TM} 2.30
Min. repetitive di/dt ①①① A/ μ sec	di/dt 600

Switching

($T_J = 25^\circ\text{C}$)

Symbol	
Max. turn-off time, $I_T = 1000\text{A}$, $T_J = 125^\circ\text{C}$ $t_p = 100$ μ sec. $dirR/dt = 50$ A/ μ sec., reappplied $dv/dt =$ 200V/ μ sec. linear to 0.8 V_{DRM} , μ sec. ②①	t_q 25 to 50
Typ. delay time, $I_{TM} = 1000\text{A}$ $T_D = .8 V_{DRM}$ ①, μ sec	t_d .5
Min. critical dv/dt exponential to .8 V_{DRM} , $T_J = 125^\circ\text{C}$, V/ μ sec ②②	dv/dt 300
Min. di/dt , non-repetitive, A/ μ sec ①①①	di/dt 1200

Gate

Maximum Parameters
($T_J = 25^\circ\text{C}$)

Symbol	
Gate current to trigger at $V_D = 12\text{V}$, mA	I_{GT} 150
Gate voltage to trigger at $V_D = 12\text{V}$, V	V_{GT} 3
Non-triggering gate voltage, $T_J = 125^\circ\text{C}$, and rated V_{DRM} , V	V_{GDM} 25-
Peak forward gate current, A	I_{GTM} 4
Peak reverse gate voltage, V	V_{GRM} 5
Peak gate power, Watts	P_{GM} 16
Average gate power, Watts	$P_{G(av)}$ 3

Thermal and Mechanical

Symbol	
Min., Max. oper. junction temp., $^\circ\text{C}$	T_J -40 to +125
Min., Max. storage temp., $^\circ\text{C}$	T_{stg} -40 to +150
Max. mounting force, lb. ①	2000 to 2400
Thermal resistance ^① , double- side cooling, junction to case, $^\circ\text{C}/\text{Watt}$	$R_{\theta JC}$.06
Case to sink, lubricated, $^\circ\text{C}/\text{Watt}$	$R_{\theta CS}$.02

- ① Consult recommended mounting procedures.
- ② Applies for zero or negative gate bias.
- ③ Per JEDEC RS-397, 5.2.2.1.
- ④ With recommended gate drive.
- ⑤ Higher dv/dt ratings available, consult factory.
- ⑥ Per JEDEC standard RS-397, 5.2.2.6.
- ⑦ For operation with antiparallel diode, consult factory.

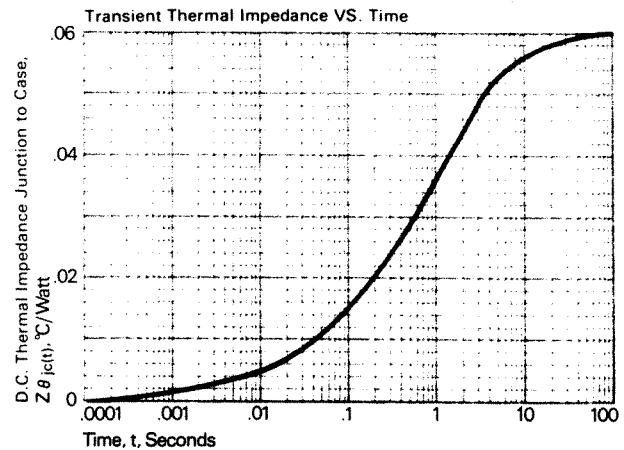
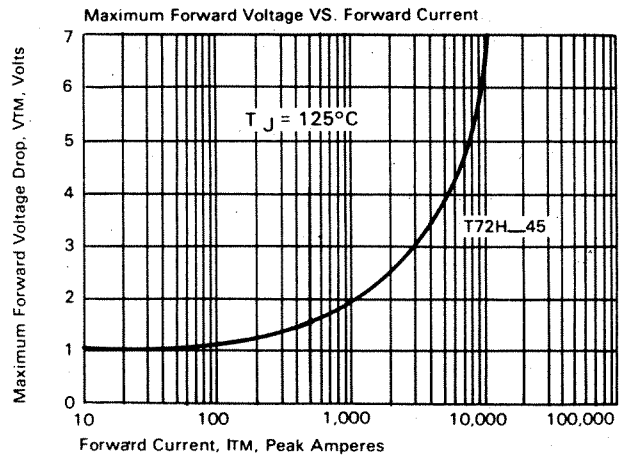

FAST SWITCHING
THYRISTORS

Fast Switching SCR T72H_45

450A Avg.
(700 RMS)
Up to 1400 Volts
25-50 μ s

Sinusoidal Current Data

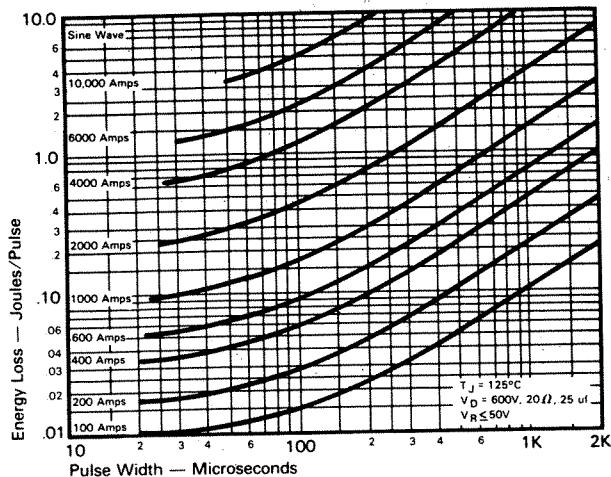

ENERGY PER PULSE FOR SINUSOIDAL PULSES

Trapezoidal Wave Current Data

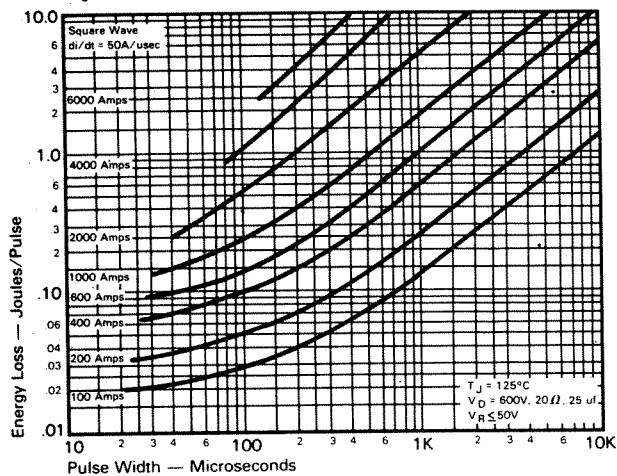

ENERGY PER PULSE FOR TRAPEZOIDAL PULSES
(di/dt = 50A/usec)

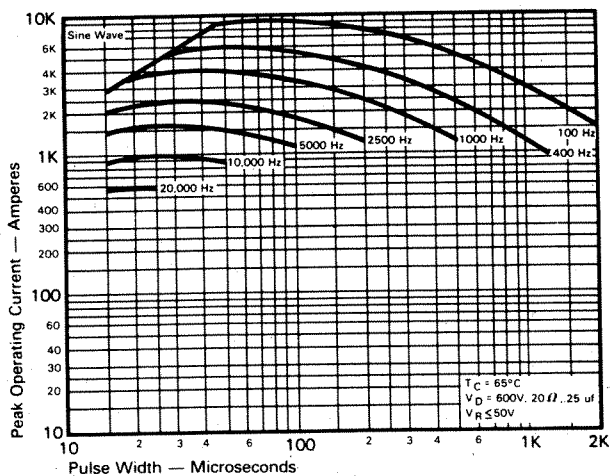

MAXIMUM ALLOWABLE PEAK ON-STATE CURRENT
vs. PULSE WIDTH ($T_C = 65^\circ\text{C}$)

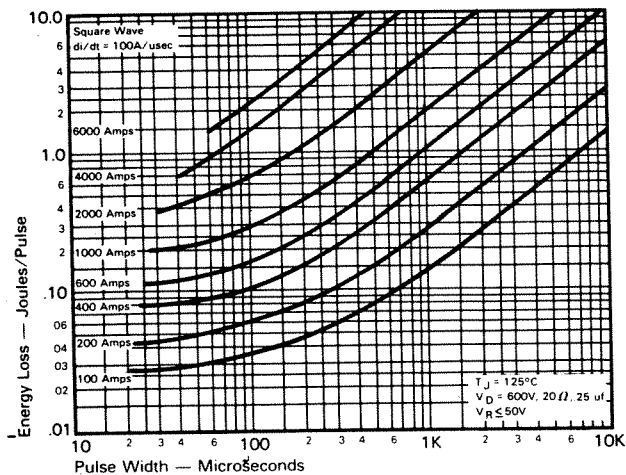

ENERGY PER PULSE FOR TRAPEZOIDAL PULSES
(di/dt = 100A/usec)

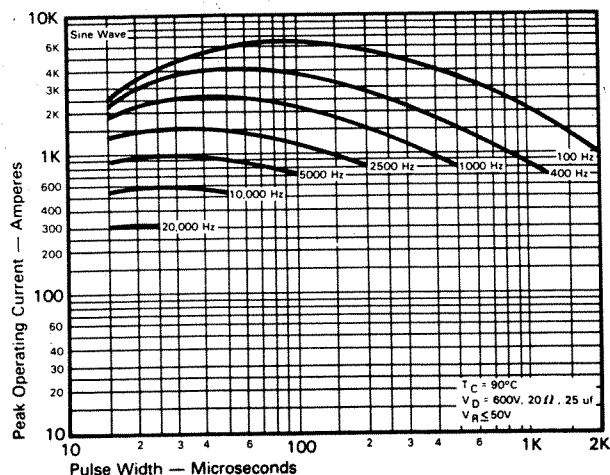

MAXIMUM ALLOWABLE PEAK ON-STATE CURRENT
vs. PULSE WIDTH ($T_C = 90^\circ\text{C}$)

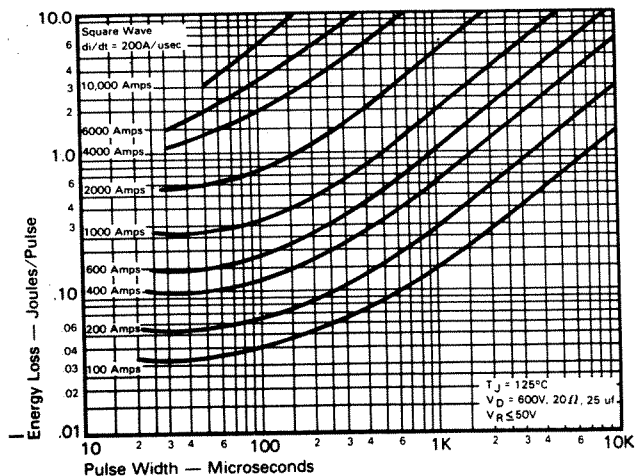

ENERGY PER PULSE FOR TRAPEZOIDAL PULSES
(di/dt = 200A/usec)

**450A Avg.
(700 RMS)
Up to 1400 Volts
25-50 μ s**

**Fast Switching
SCR
T72H_45**

**Trapezoidal Wave Current Data
($T_C = 65^\circ\text{C}$)**

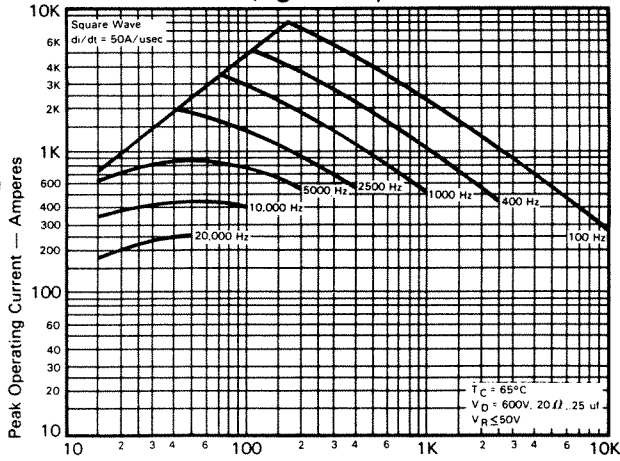

MAXIMUM ALLOWABLE PEAK ON-STATE CURRENT vs. PULSE WIDTH ($di/dt = 50A/usec$)

**Trapezoidal Wave Current Data
($T_C = 90^\circ\text{C}$)**

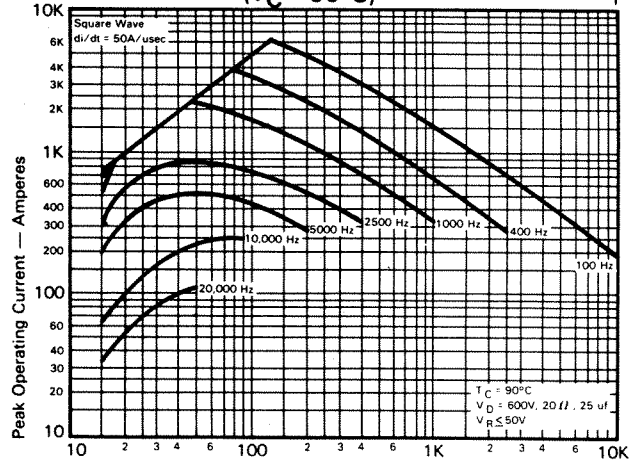

MAXIMUM ALLOWABLE PEAK ON-STATE CURRENT vs. PULSE WIDTH ($di/dt = 50A/usec$)

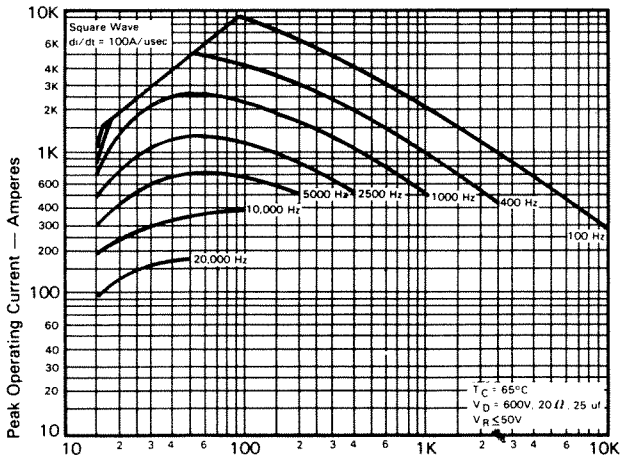

MAXIMUM ALLOWABLE PEAK ON-STATE CURRENT vs. PULSE WIDTH ($di/dt = 100A/usec$)

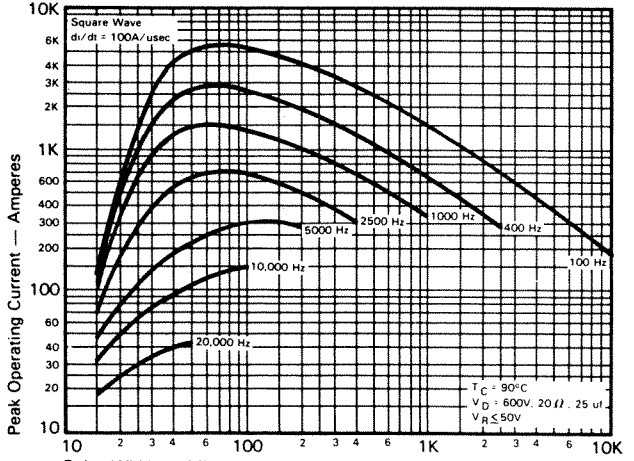

MAXIMUM ALLOWABLE PEAK ON-STATE CURRENT vs. PULSE WIDTH ($di/dt = 100A/usec$)

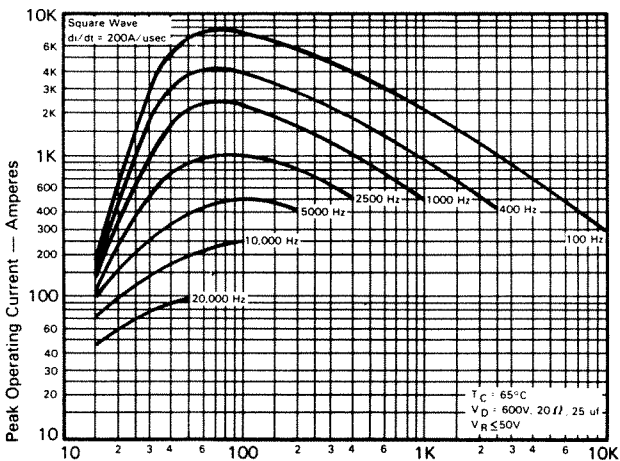

MAXIMUM ALLOWABLE PEAK ON-STATE CURRENT vs. PULSE WIDTH ($di/dt = 200A/usec$)

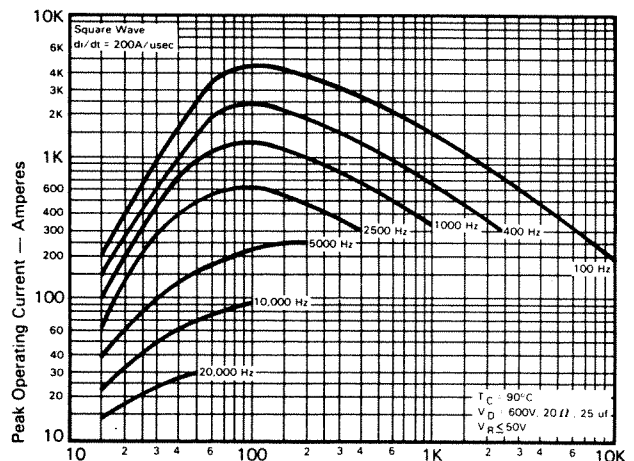

MAXIMUM ALLOWABLE PEAK ON-STATE CURRENT vs. PULSE WIDTH ($di/dt = 200A/usec$)

**FAST SWITCHING
THYRISTORS**