

800MHz BAND LOW NOISE AMPLIFIER GaAs MMIC

■GENERAL DESCRIPTION

NJG1104KB2 is a variable gain low noise amplifier (LNA).

At 800MHz band, noise figure is 1.2dB, variable gain range is 21dB and input 3rd order intercept point is +6dBm. These characteristics are very suitable for CDMA cellular phone application.

The variable attenuators placed in front of LNA realize wide range of input power with low distortion.

An ultra small and ultra thin FLP6-B2 package is adopted.

■PACKAGE OUTLINE



NJG1104KB2

■FEATURES

- | | |
|-----------------------------------|---|
| ●Low voltage operation | +2.8V typ. |
| ●Low current consumption | 6.0mA typ. |
| ●High gain | 15dB typ. @f=865MHz |
| ●Low noise figure | 1.2dB typ. @f=865MHz |
| ●Variable gain control | 21dB typ. @f=865MHz, $V_{CONT}=0.2$ to 1.7V |
| ●High input IP3 | +6dBm typ. @f=865.0+865.1MHz, $P_{in}=-30$ dBm |
| ●High output IP3 | +21dBm typ. @f=865.0+865.1MHz, $P_{in}=-30$ dBm |
| ●Ultra small & ultra thin package | FLP6-B2 (Mount Size: 2.1x2.0x0.75mm) |

■PIN CONFIGURATION

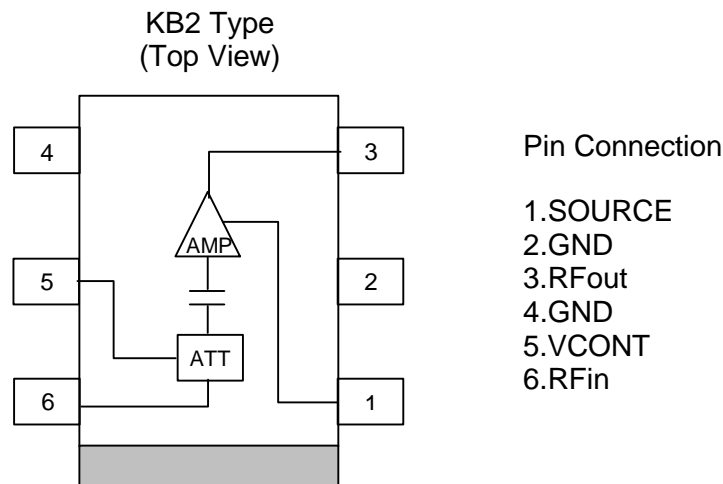

Note: The portion above shows orientation mark printed on the package surface.

NJG1104KB2

■ABSOLUTE MAXIMUM RATINGS

($T_a=25^{\circ}\text{C}$, $Z_s=Z_l=50\Omega$)

PARAMETER	SYMBOL	CONDITIONS	RATINGS	UNITS
Drain Voltage	V_{DD}		6.0	V
Gain Control Voltage	V_{CONT}		4.0	V
Input Power	P_{in}	$V_{DD}=2.8\text{V}$	+20	dBm
Power Dissipation	P_D		450	mW
Operating Temperature	T_{opr}		-40~+85	$^{\circ}\text{C}$
Storage Temperature	T_{stg}		-55~+125	$^{\circ}\text{C}$

■ELECTRICAL CHARACTERISTICS

($V_{DD}=2.8\text{V}$, $V_{CONT}=1.7\text{V}$, $f=865\text{MHz}$, $T_a=25^{\circ}\text{C}$, $Z_s=Z_l=50\Omega$)

PARAMETER	SYMBOL	CONDITIONS	MIN	TYP	MAX	UNITS
Operating Frequency	freq		830	865	900	MHz
Drain Voltage	V_{DD}		2.7	2.8	5.5	V
Gain Control Voltage	V_{CONT}		0.2	1.7	3.0	V
Operating Current	I_{DD}	No RF Signal	-	6.0	7.5	mA
Gain Control Terminal Current	I_{CONT}	No RF Signal	-	1.0	5.0	μA
Small Signal Gain	Gain		13.0	15.0	17.0	dB
Gain Flatness	G_{flat}	$f=830\sim 900\text{MHz}$	-	0.5	1.0	dB
Gain Control Range	G_{CONT}	$V_{CONT}=0.2\text{V}, 1.7\text{V}$	18.5	20.5	22.5	dB
Noise Figure	NF		-	1.20	1.40	dB
Pout at 1dB Gain Compression point	P_{-1dB}		-	+8.0	-	dBm
Output 3rd Order Intercept Point	OIP3	$f=865.0+865.1\text{MHz}$ $P_{in}=-30\text{dBm}$	+19.0	+21.0	-	dBm
Input 3rd Order Intercept Point 1	IIP3-1	$f=865.0+865.1\text{MHz}$ $P_{in}=-30\text{dBm}$	+4.0	+6.0	-	dBm
Input 3rd Order Intercept Point 2	IIP3-2	$f=865.0+865.1\text{MHz}$ $P_{in}=-10\text{dBm}$ $V_{CONT}=0.2\text{V}$	+21.0	+26.0	-	dBm
RF Input Port VSWR	$VSWR_i$		-	1.5	2.0	-
RF Output Port VSWR	$VSWR_o$		-	1.5	2.0	-

■ TERMINAL INFORMATION

Pin	Function	Description
1	SOURCE	This terminal is internally connected to FET's source of LNA. Please connect self-bias resistor (R1) and bypass capacitor (C3) through source inductor (L5). NF and IIP3 are tunable by C3 and L5.
2, 4	GND	Ground (0V) terminal. Ground plane should be placed as close to the ground terminals. .
3	RFout	RF output and drain voltage supplies terminal. External matching circuit is required.
5	VCONT	Gain control voltage (V_{CONT}) supplies terminal.
6	RFIn	RF input terminal. External matching circuit and DC blocking capacitor are required.

NJG1104KB2

TYPICAL CHARACTERISTICS

NF,Gain vs. frequency

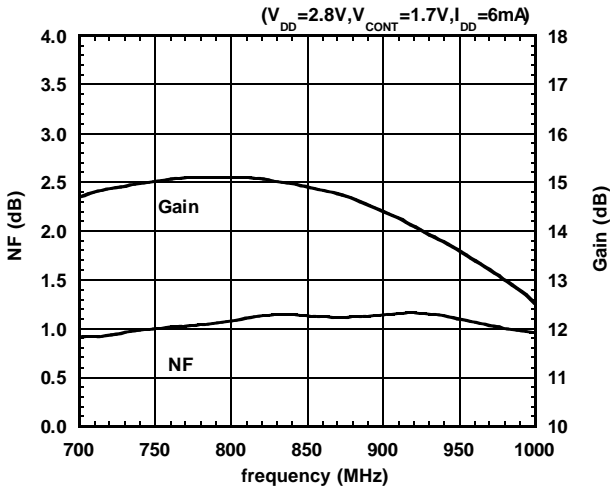

NF,Gain vs. frequency

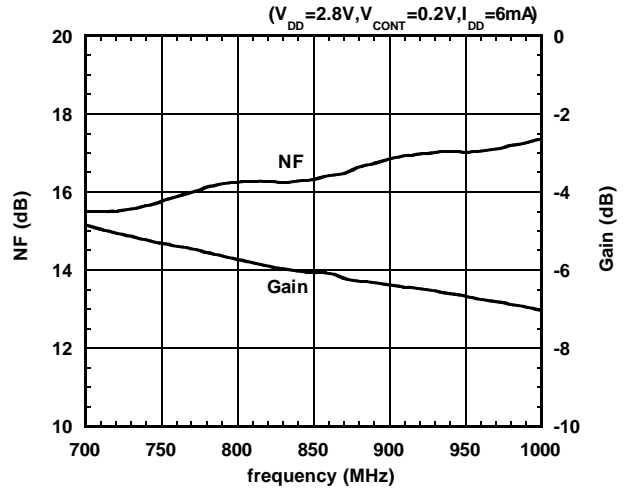

Pout,Gain vs. Pin

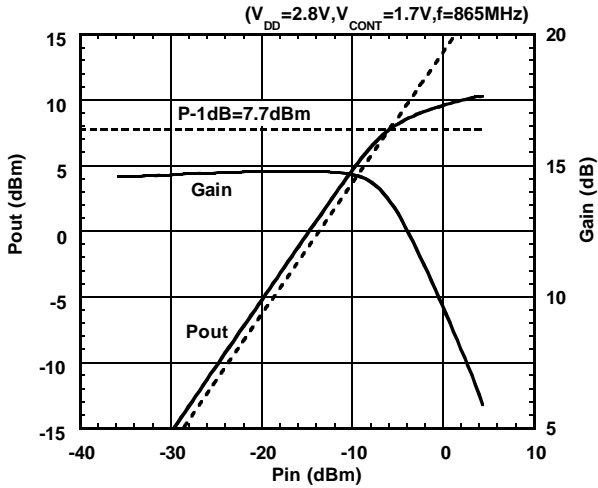

Pout,Gain vs. Pin

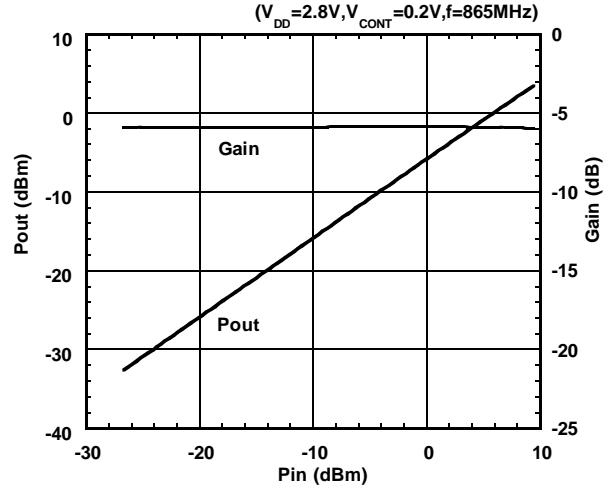

Pout, IM3 vs. Pin

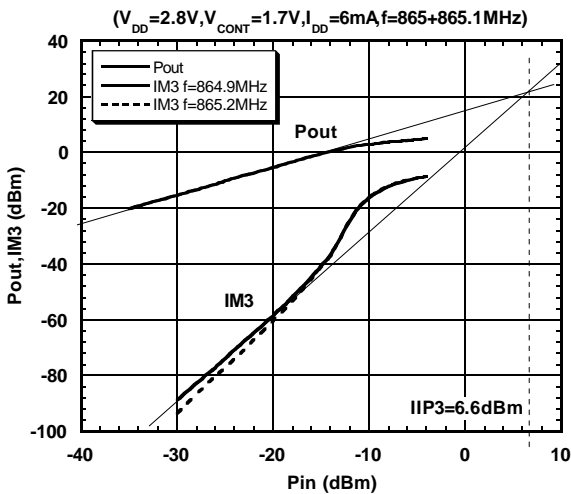

Pout, IM3 vs. Pin

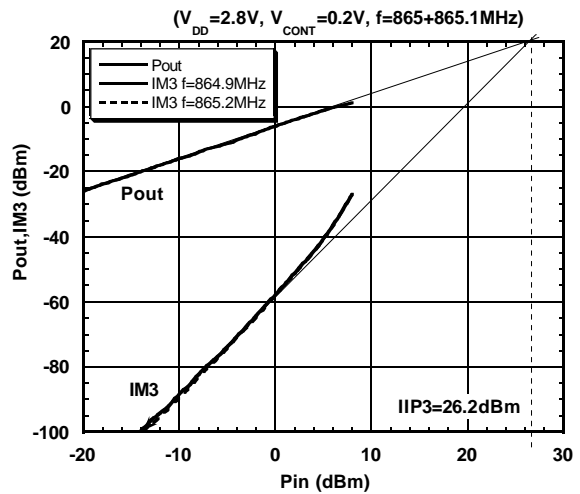

■ TYPICAL CHARACTERISTICS

NF, Gain vs. VCONT

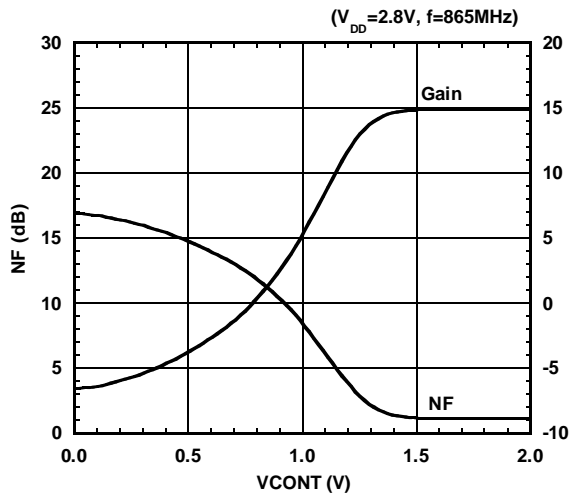

OIP3, IIP3 vs. VCONT

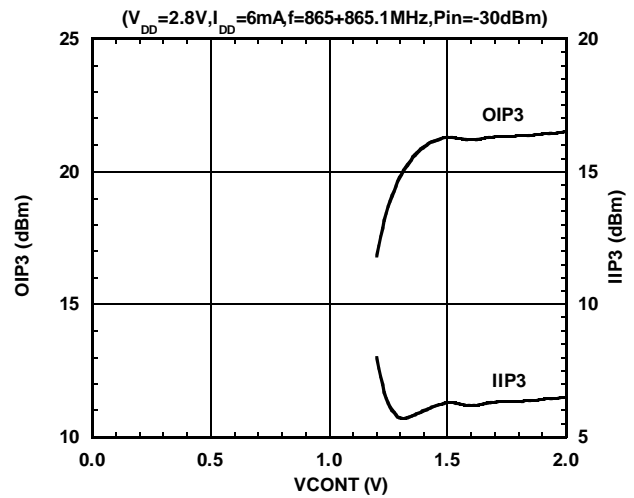

NF, Gain vs. IDD

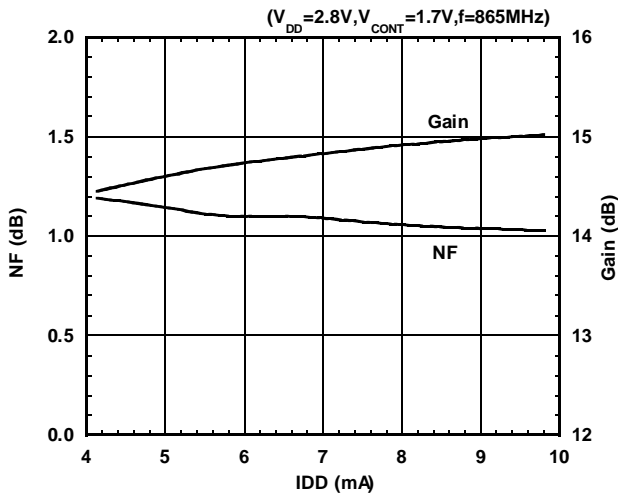

OIP3, IIP3 vs. IDD

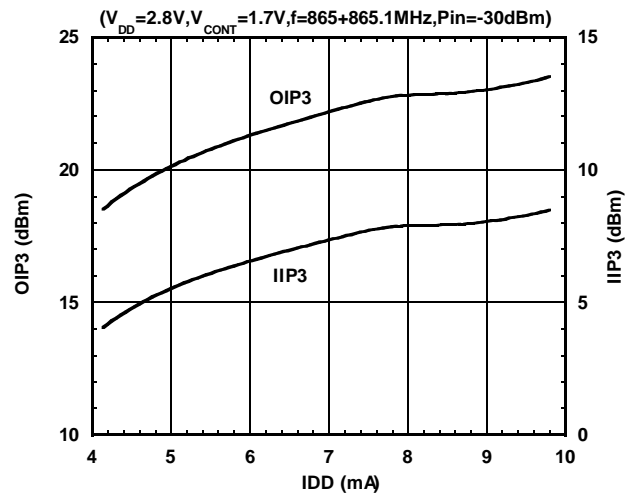

Rbias vs. IDD

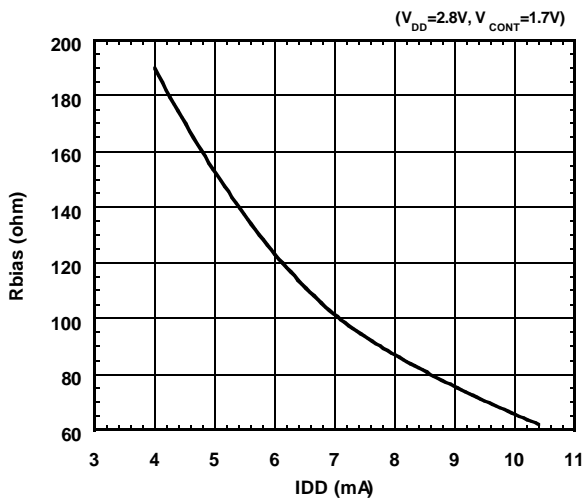

Equations of OIP3 and IIP3

$$OIP3 = \frac{3 \times P_{out} - IM3}{2}$$

$$IIP3 = OIP3 - Gain$$

$$V_{CONT} = 1.7V @ Pin = -30dBm$$

$$V_{CONT} = 0.2V @ Pin = -10dBm$$

NJG1104KB2

TYPICAL CHARACTERISTICS

NF,Gain vs. VDD

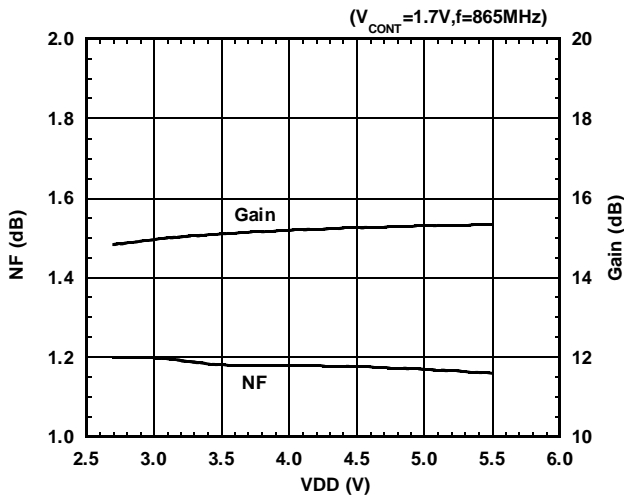

OIP3,IIP3 vs. VDD

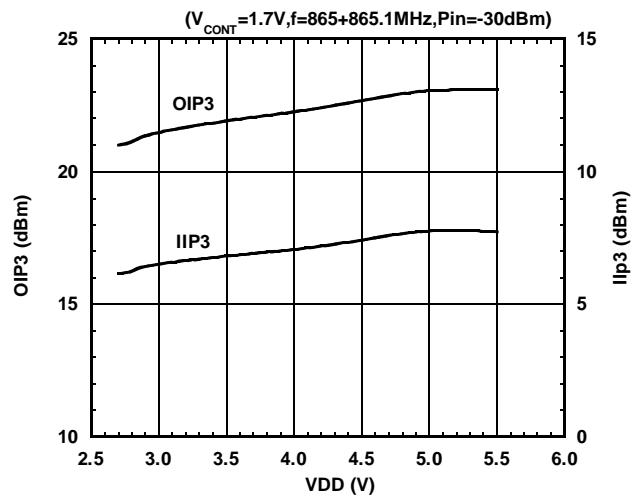

IDD vs. VDD

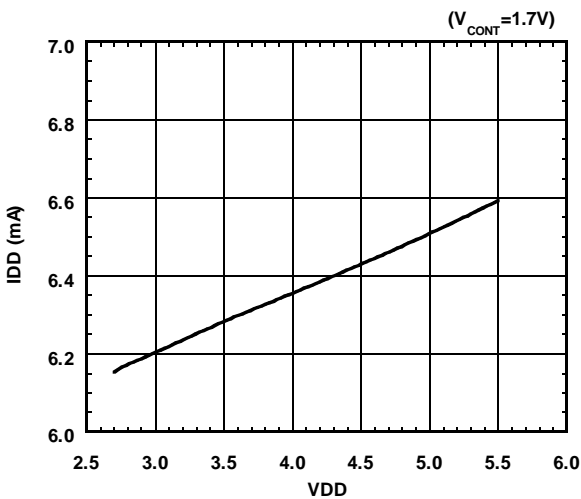

OIP3,IIP3 vs. frequency

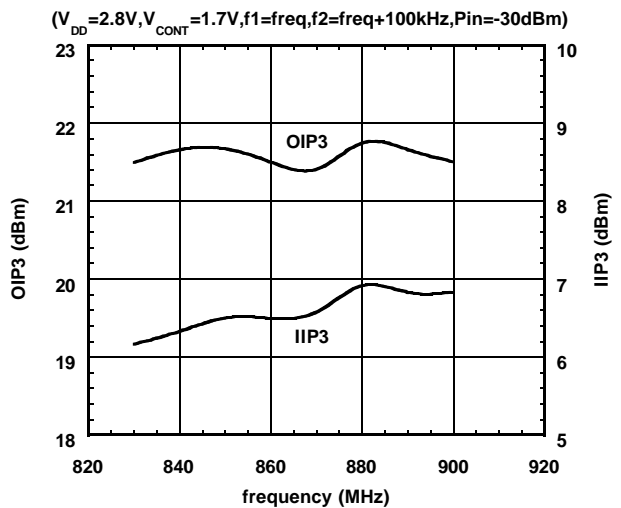

IDD vs. Ta

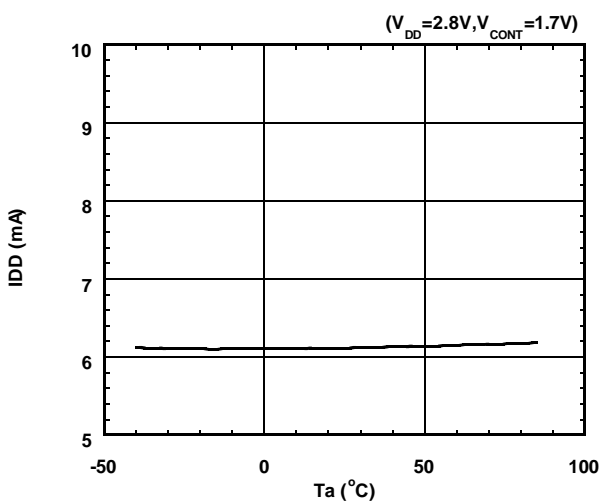

Equations of OIP3 and IIP3

$$OIP3 = \frac{3 \times P_{out} - IM3}{2}$$

$$IIP3 = OIP3 - Gain$$

VCONT=1.7V@ Pin=-30dBm

VCONT=0.2V@ Pin=-10dBm

TYPICAL CHARACTERISTICS

Gain vs. VCONT(Variable Ta)

($V_{DD}=2.8V, freq=865MHz$)

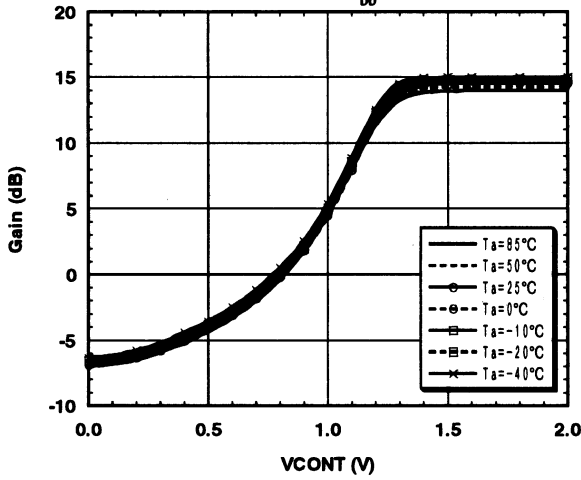

Gain vs. Ta (Variable VCONT)

($V_{DD}=2.8V, freq=865MHz$)

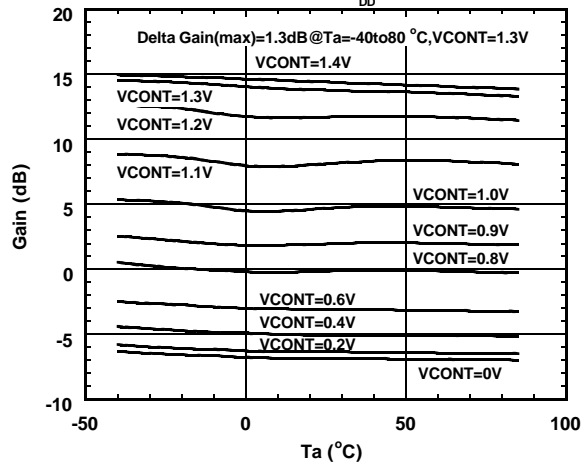

NF, Gain vs. Ta

($V_{DD}=2.8V, V_{CONT}=1.7V, freq=865MHz$)

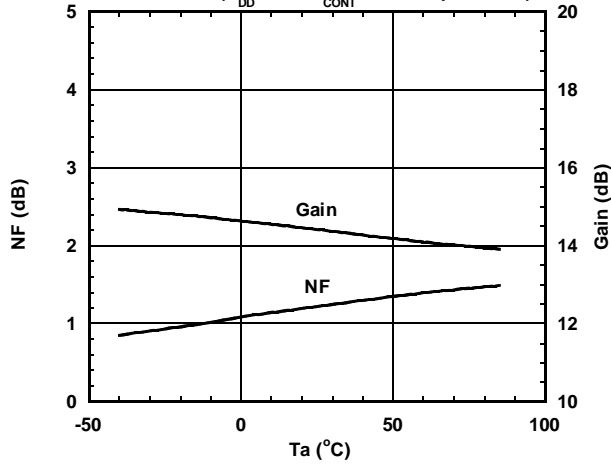

NF, Gain vs. Ta

($V_{DD}=2.8V, V_{CONT}=0.2V, freq=865MHz$)

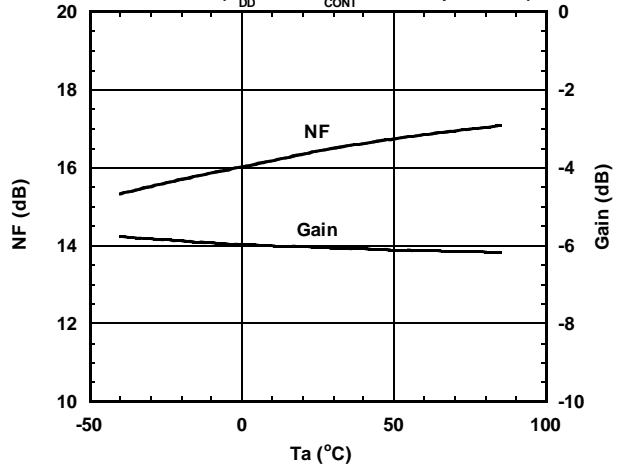

OIP3, IIP3 vs. Ta

($V_{DD}=2.8V, V_{CONT}=1.7V, freq=865+865.1MHz, Pin=-30dBm$)

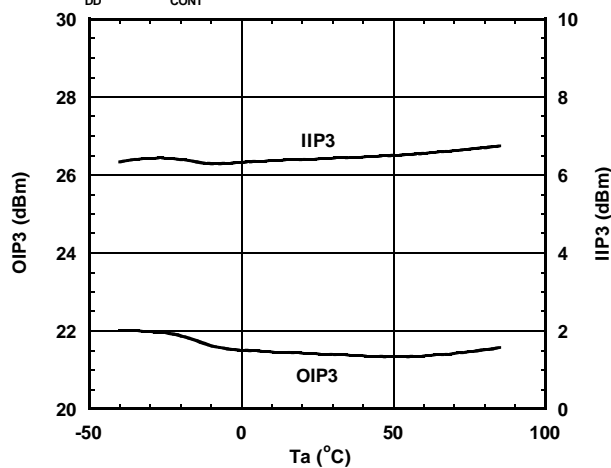

OIP3, IIP3 vs. Ta

($V_{DD}=2.8V, V_{CONT}=0.2V, freq=865+865.1MHz, Pin=-10dBm$)

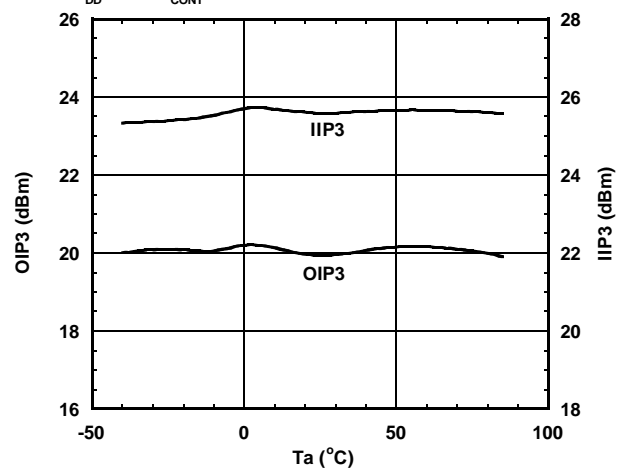

NJG1104KB2

■ TYPICAL CHARACTERISTICS

S11,S21,S12,S22 vs. frequency

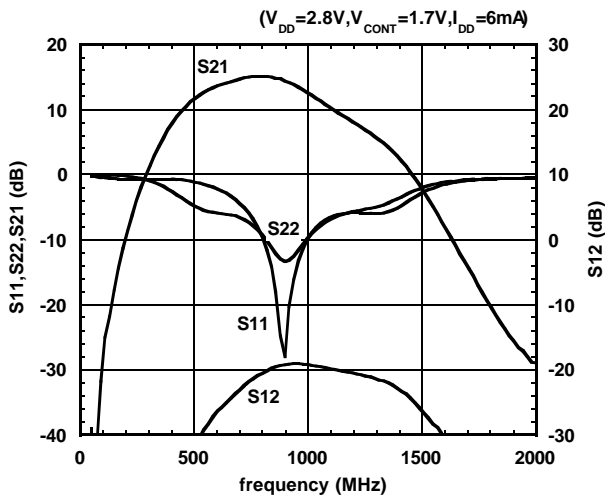

S11,S21,S12,S22 vs. frequency

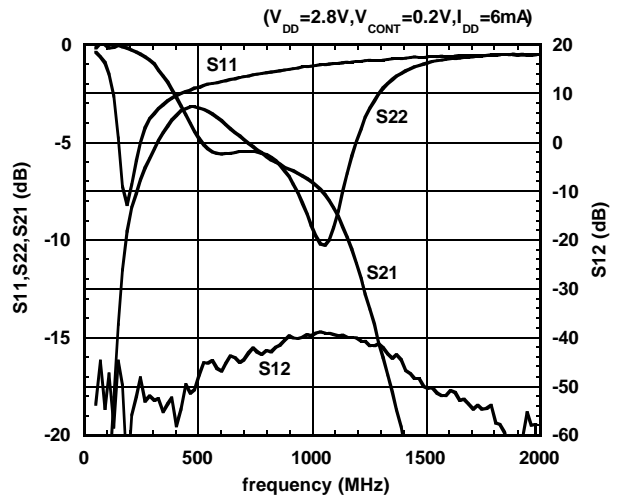

S11,S22 vs. frequency

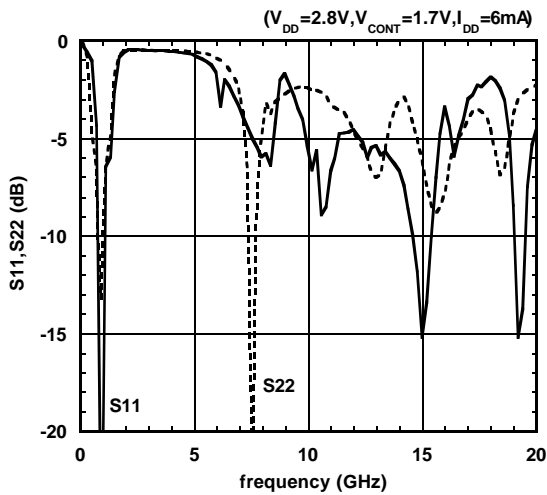

S11,S22 vs. frequency

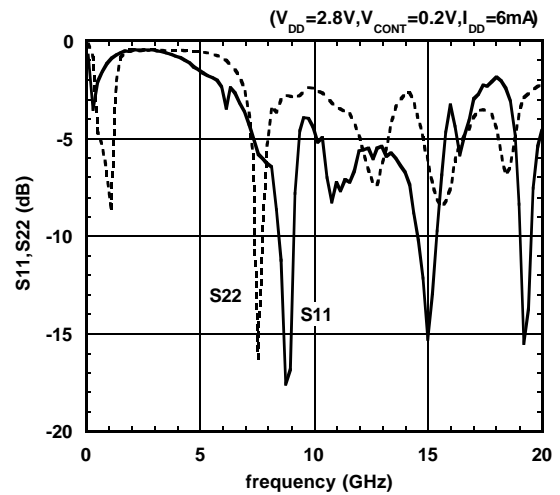

S21,S12 vs. frequency

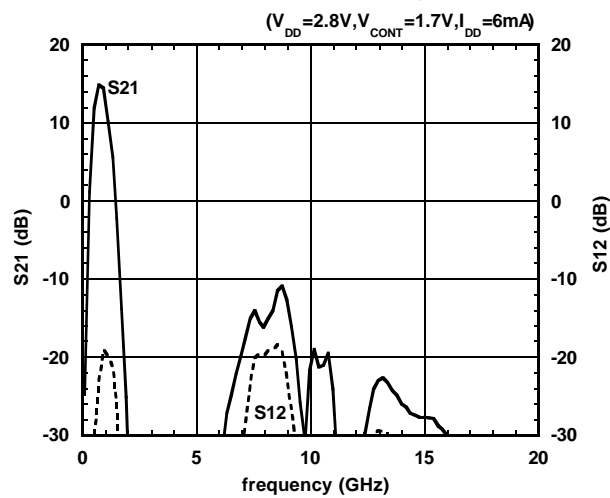

S21,S12 vs. frequency

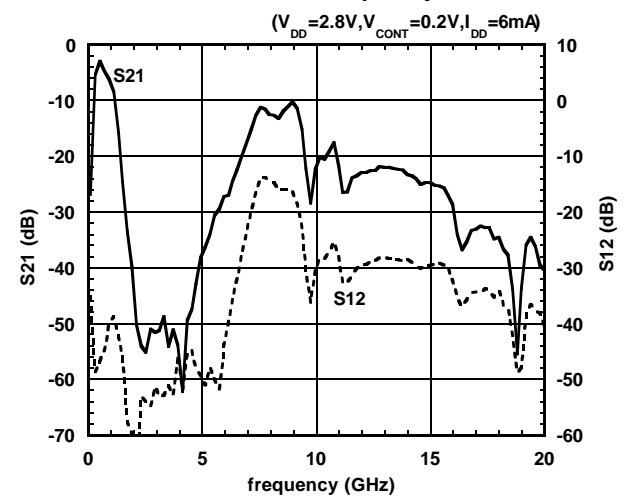

■ TYPICAL CHARACTERISTICS

Scattering Parameter Table at Maximum Gain

$V_{DD}=2.8V$, $V_{CONT}=1.7V$, $I_{DD}=6.1mA$, $Z_0=50\Omega$

Freq (MHz)	S11		S21		S12		S22	
	mag (units)	ang (deg)	mag (units)	ang (deg)	mag (units)	ang (deg)	mag (units)	ang (deg)
100	0.990	-3.7	2.893	-162.9	0.011	94.9	0.795	-9.3
200	0.983	-7.0	3.258	171.6	0.008	56.3	0.725	-7.2
300	0.967	-9.9	3.125	154.6	0.011	85.4	0.744	-5.8
400	0.946	-12.5	2.910	141.2	0.014	84.2	0.770	-6.8
500	0.927	-14.8	2.648	130.2	0.020	87.7	0.792	-8.8
600	0.909	-16.8	2.407	120.6	0.025	87.5	0.819	-11.5
700	0.896	-18.5	2.182	112.6	0.029	84.5	0.835	-14.5
800	0.884	-19.9	1.975	105.2	0.034	81.0	0.849	-17.6
900	0.876	-21.3	1.790	98.9	0.039	78.6	0.864	-20.8
1000	0.871	-22.7	1.624	92.9	0.044	77.3	0.874	-24.0
1100	0.867	-24.1	1.480	87.4	0.048	73.1	0.880	-27.2
1200	0.864	-25.3	1.349	82.2	0.054	71.6	0.884	-30.5
1300	0.860	-26.8	1.234	77.4	0.059	68.3	0.891	-33.8
1400	0.861	-28.1	1.129	72.7	0.063	66.2	0.897	-37.1
1500	0.862	-29.7	1.029	68.2	0.068	63.8	0.903	-40.4
1600	0.862	-31.3	0.942	63.8	0.072	61.0	0.907	-43.8
1700	0.863	-33.0	0.860	59.4	0.078	57.7	0.912	-47.4
1800	0.867	-34.7	0.783	55.2	0.083	55.4	0.916	-50.6
1900	0.869	-36.5	0.713	51.1	0.087	52.4	0.920	-54.0
2000	0.874	-38.4	0.650	47.3	0.091	50.5	0.921	-57.6

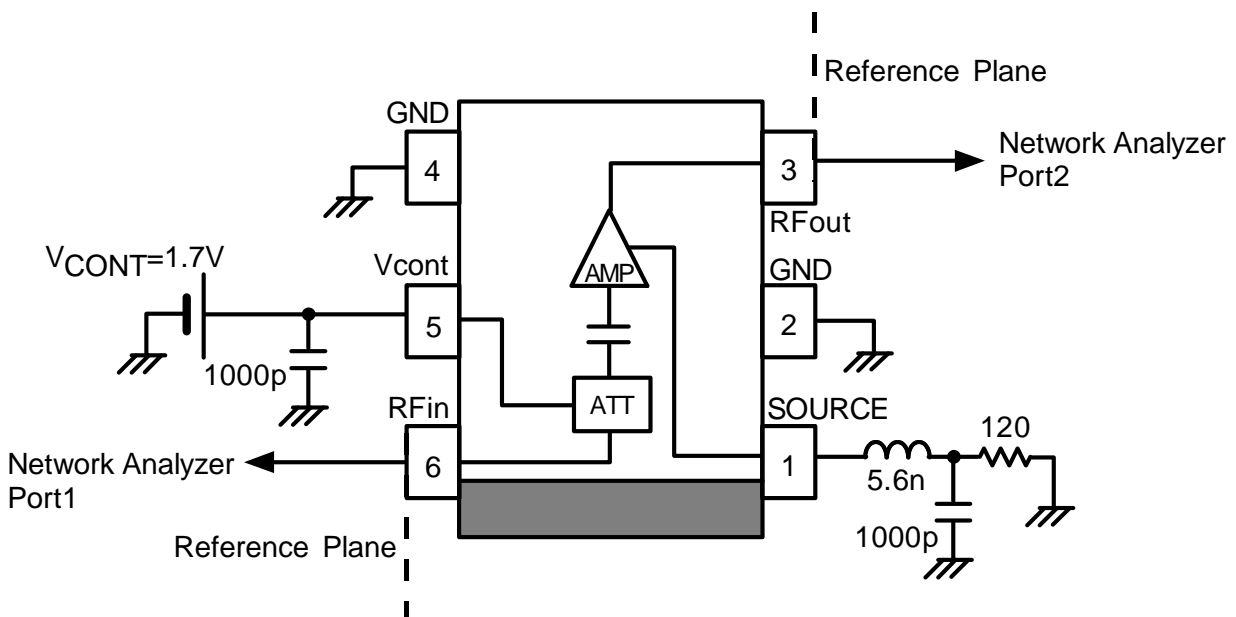

Note

V_{DD} (=2.8V) is supplied through "BIAS CONNECT (PORT2)" of Network Analyzer.

NJG1104KB2

■ TYPICAL CHARACTERISTICS

Scattering Parameter Table at Minimum Gain

$V_{DD}=2.8V$, $V_{CONT}=0.2V$, $I_{DD}=6.1mA$, $Z_0=50\Omega$

Freq (MHz)	S11		S21		S12		S22	
	mag (units)	ang (deg)	mag (units)	ang (deg)	mag (units)	ang (deg)	mag (units)	ang (deg)
100	0.771	-62.4	2.226	171.8	0.002	-94.5	0.784	-9.3
200	0.573	-99.1	1.803	141.7	0.004	25.2	0.728	-6.5
300	0.480	-121.8	1.405	128.1	0.005	37.2	0.744	-4.9
400	0.430	-138.2	1.151	119.5	0.003	70.3	0.774	-5.6
500	0.405	-150.1	0.975	113.2	0.007	67.3	0.801	-7.5
600	0.391	-159.8	0.849	107.8	0.007	67.3	0.829	-10.2
700	0.381	-167.4	0.749	103.2	0.009	76.9	0.850	-13.2
800	0.373	-174.5	0.666	99.0	0.010	70.2	0.867	-16.4
900	0.369	179.3	0.597	95.3	0.013	75.7	0.884	-19.8
1000	0.366	173.4	0.538	91.7	0.014	73.3	0.897	-23.1
1100	0.365	168.5	0.489	88.4	0.015	74.7	0.905	-26.4
1200	0.365	163.1	0.443	84.9	0.017	73.9	0.910	-29.8
1300	0.367	158.7	0.406	81.9	0.019	70.8	0.918	-33.2
1400	0.369	154.2	0.371	78.8	0.020	68.7	0.923	-36.7
1500	0.372	150.2	0.338	76.0	0.021	65.2	0.930	-40.0
1600	0.374	146.3	0.310	73.1	0.023	63.8	0.932	-43.4
1700	0.378	142.6	0.283	70.6	0.024	64.2	0.938	-47.0
1800	0.384	139.1	0.257	67.8	0.026	63.6	0.942	-50.4
1900	0.388	136.5	0.232	64.7	0.027	60.2	0.944	-53.9
2000	0.388	133.1	0.211	62.7	0.029	59.5	0.947	-57.6

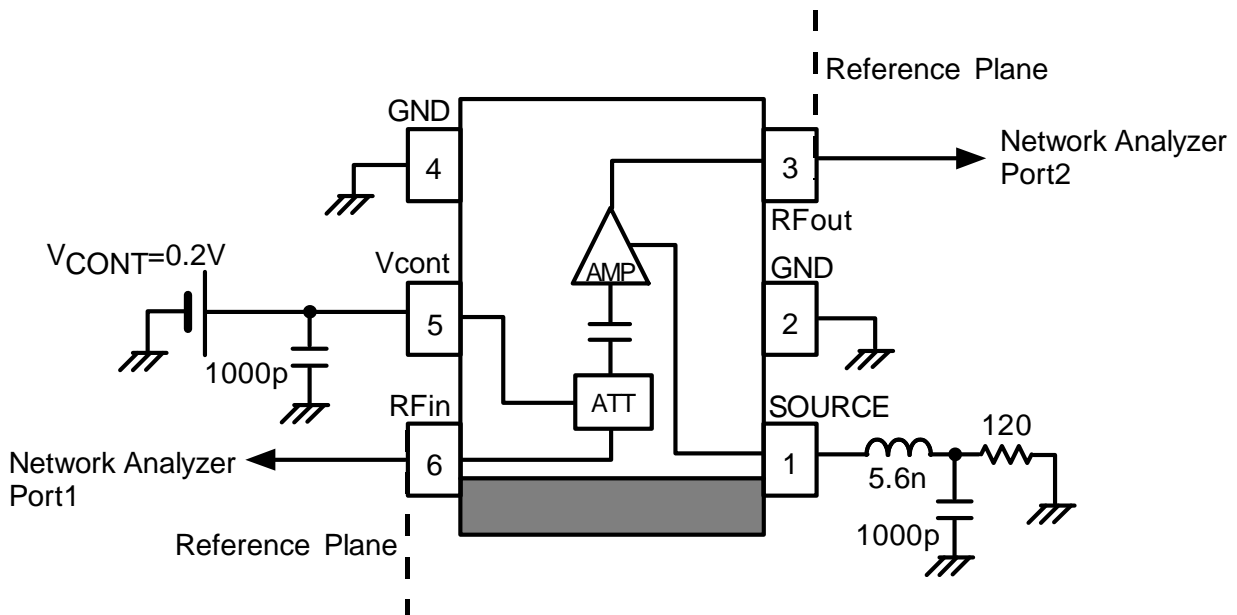

Note

V_{DD} (=2.8V) is supplied through "BIAS CONNECT (PORT2)" of Network Analyzer.

RECOMMENDED CIRCUIT

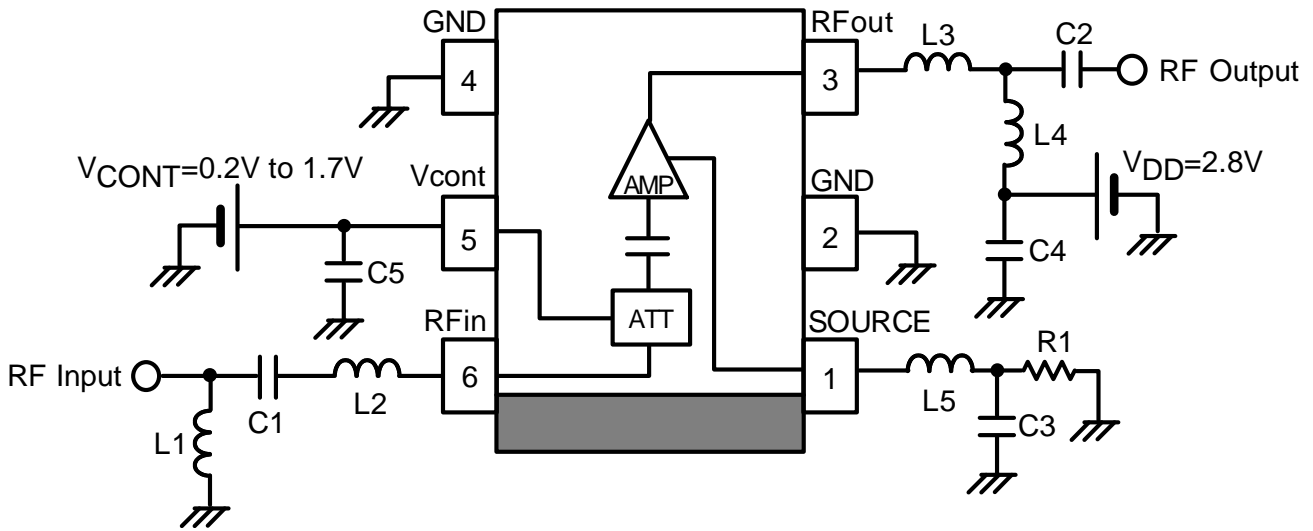

RECOMMENDED PCB DESIGN

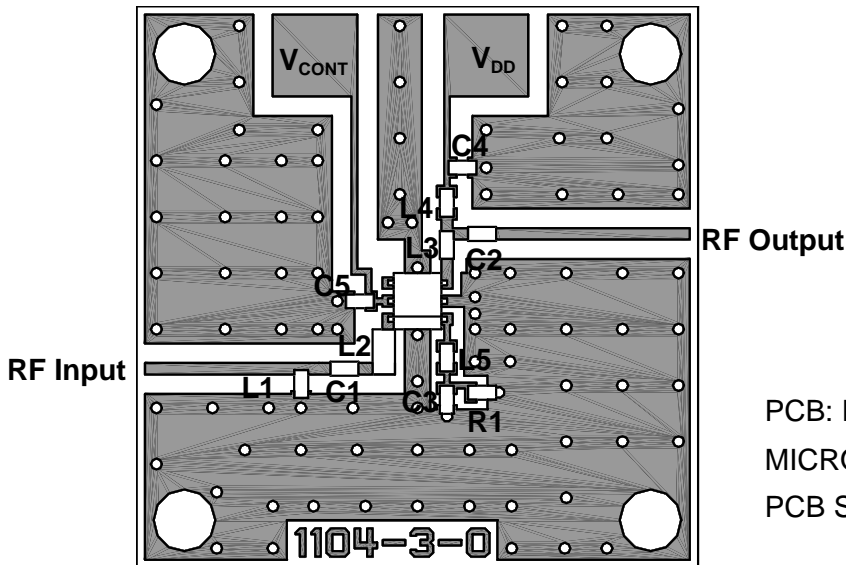

PCB: FR4 t=0.2mm
 MICROSTRIP LINE WIDTH=0.4mm($Z_0=50\Omega$)
 PCB SIZE: 20.0x20.0mm

Parts List (f=830~900MHz)

PARTS ID	Constant	Comment
L1	22nH	TAIYO-YUDEN HK1005 Series
L2	22nH	TAIYO-YUDEN HK1608 Series
L3	22nH	TAIYO-YUDEN HK1005 Series
L4	15nH	TAIYO-YUDEN HK1005 Series
L5	5.6nH	TAIYO-YUDEN HK1005 Series
C1, C4, C5	1000pF	MURATA GRM36 Series
C2	6pF	MURATA GRM36 Series
C3	100pF	MURATA GRM36 Series
R1	120 Ω	-

PRECAUTIONS

- 1) The inductor of 1608 size is recommended for NF characteristics.
- 2) The value of C3 is selected to get lower gain and higher output IP3.

NJG1104KB2

PACKAGE OUTLINE (FLP6-B2)

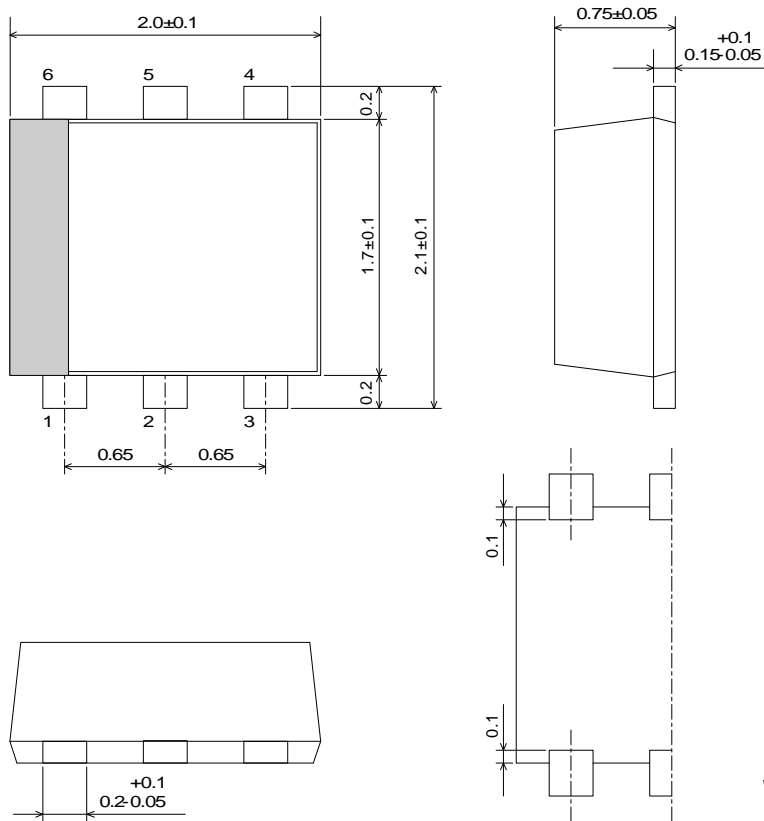

Lead material : Copper
 Lead surface finish: Solder plating
 Molding material : Epoxy resin
 UNIT : mm
 Weight : 6.5mg

Cautions on using this product

This product contains Gallium-Arsenide (GaAs) which is a harmful material.

- Do NOT eat or put into mouth.
- Do NOT dispose in fire or break up this product.
- Do NOT chemically make gas or powder with this product.
- To waste this product, please obey the relating law of your country.

[CAUTION]

The specifications on this databook are only given for information, without any guarantee as regards either mistakes or omissions. The application circuits in this databook are described only to show representative usages of the product and not intended for the guarantee or permission of any right including the industrial rights.

This product may be damaged with electric static discharge (ESD) or spike voltage. Please handle with care to avoid these damages.