

DC/DC Converter for IGBT driver



Continuous Short Circuit Protection



FEATURES

- Efficiency up to 80%
- Ultra Compact SIP package
- Good temperature characteristic
- Isolation voltage : 3K VAC
- Ultra low isolation capacitance
- Operating temperature range: -40°C~+105°C
- No-load operation allowed

UL **US** **CB** Patent Protection **RoHS**

QA series are DC-DC converters for IGBT drivers. Their ultra low isolation capacitance can improve the capability of anti-interference. The built-in common-ground mode of the unique asymmetric voltage output mode reduces the driver loss of IGBT driver. They feature short-circuit protection and auto-recovery, and can be widely used in:

1. General inverter
2. AC servo drive system
3. Electric welding machine
4. Uninterruptible power supply (UPS)

Selection Guide

Certification	Part No.	Input		Output		Efficiency (%Min./Typ) @ Full Load	Max. Capacitive Load (μF)
		Input Voltage(VDC) Nominal(Range)	Input Current(mA, Typ.) full load/no-load	Output Voltage (VDC)+Vo/-Vo	Output Current (mA)+Io/-Io		
UL/ CB	QA01	15 (14.5-15.5)	130/20	+15/-8.7	+80/-40	78/80	220
	QA01-09		84/20	+9.0/--	+111/--		
	QA01-A09		84/20	+9.0/-9.0	+55/-55		
	QA01-17		143/20	+17/-8.7	+80/-40		
	QA02	12 (11.6-12.4)	162/20	+15/-8.7	+80/-40		
	QA03	24 (23.3-24.7)	81/20	+15/-8.7	+80/-40		
	QA04	12 (9-15)	223/20	+15/-8.0	+100/-80		

Input Specifications

Item	Operating Conditions	Min.	Typ.	Max.	Unit	
Input Voltage	QA01*	DC	-0.7	--	16	VDC
	QA02	DC	-0.7	--	13	
	QA03	DC	-0.7	--	26	
	QA04	DC	-0.7	--	15	
Input Filter		Filter capacitor				
Hot Plug		Unavailable				

Note: QA01* refers to all models begin with QA01.

Output Specifications

Item	Operating Conditions	Min.	Typ.	Max.	Unit		
Output Voltage	QA01	+Vo	Vin=15VDC, Pin6 & Pin7 +Io=+80mA	14	15	16	VDC
		-Vo	Vin=15VDC, Pin5 & Pin6 -Io=-40mA	-7	-8.7	-10	
	QA01-09	+Vo	Vin=15VDC, Pin6 & Pin7 +Io=+111mA	8	9	10	
		-Vo	--	--	--	--	
	QA01-A09	+Vo	Vin=15VDC, Pin6 & Pin7 +Io=+55mA	8	9	10	
		-Vo	Vin=15VDC, Pin5 & Pin6 -Io=-55mA	-8	-9	-10	

Output Voltage	QA01-17	+Vo	Vin=15VDC, Pin6 & Pin7 +Io=+80mA	16.5	17	18	VDC
		-Vo	Vin=15VDC, Pin5 & Pin6 -Io=-40mA	-7	-8.7	-10	
	QA02	+Vo	Vin=12VDC, Pin6 & Pin7 +Io=+80mA	14	15	16	
		-Vo	Vin=12VDC, Pin5 & Pin6 -Io=-40mA	-7	-8.7	-10	
	QA03	+Vo	Vin=24VDC, Pin6 & Pin7 +Io=+80mA	14	15	16	
		-Vo	Vin=24VDC, Pin5 & Pin6 -Io=-40mA	-7	-8.7	-10	
	QA04	+Vo	Vin=12VDC, Pin6 & Pin7 +Io=+100mA	14	15	16	
		-Vo	Vin=12VDC, Pin5 & Pin6 -Io=-80mA	-7	-8	-9	
Output Voltage Accuracy		QA01-09		--	±4	±6	%
		Other models		See tolerance envelope graph (Fig. 1)			
Line Regulation		Input voltage range		--	±1.2	±1.5	--
Load Regulation		10%-100% load	QA01-09	--	12	26	%
			Other models	Positive output	--	8	
		Negative output		--	10	15	
Temperature Coefficient		Full load		--	--	±0.03	%/°C
Ripple & Noise*		20MHz bandwidth		--	100	200	mVp-p
Short Circuit Protection		Continuous, self-recovery					

Note: * Ripple and noise are measured by "parallel cable" method, please see DC-DC Converter Application Notes for specific operation.

General Specifications

Item	Operating Conditions	Min.	Typ.	Max.	Unit
Isolation Voltage	Input-output, with the test time of 1 minute and the leak current lower than 1mA	3000	--	--	VAC
Isolation Resistance	Input-output, Isolation voltage 500VDC	1000	--	--	MΩ
Isolation Capacitance	Input-output, 100KHz/0.1V	--	6.6	--	pF
Operating Temperature	Derating when operating temperature up to 85°C, (see Fig. 2)	-40	--	105	°C
Storage Temperature		-55	--	125	
Pin Welding Resistance Temperature	Welding spot is 1.5mm away from the casing, 10 seconds	--	--	300	
Casing Temperature Rise	Ta=25°C, nominal input, full load output	--	25	--	
Storage Humidity	Non-condensing	--	--	95	%RH
Switching Frequency	Full load, nominal input voltage	--	100	300	KHz
MTBF	MIL-HDFK-217F@25°C	3500	--	--	K hours

Physical Specifications

Casing Material	Black flame-retardant and heat-resistant plastic (UL94-V0)
Dimension	19.50*9.80*12.50mm
Weight	4.30g (Typ.)
Cooling Method	Free convection

EMC Specifications

EMI	CE	CISPR22/EN55022 CLASS B (see Fig. 4 for recommended circuit)
	RE	CISPR22/EN55022 CLASS B (see Fig. 4 for recommended circuit)
EMS	ESD	IEC/EN61000-4-2 Contact ±8KV perf. Criteria B

Product Characteristic Curve

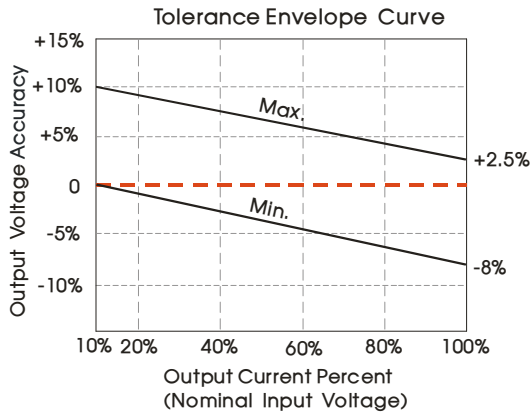

Fig. 1
(Excluding QA01-09 model)

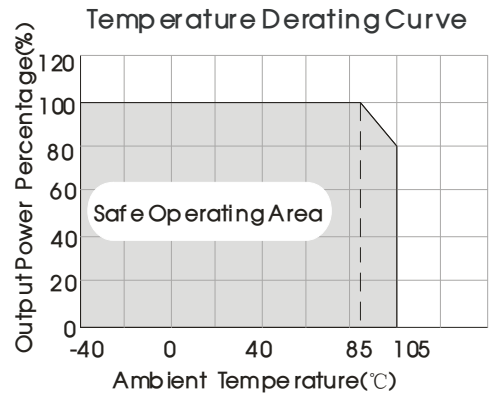
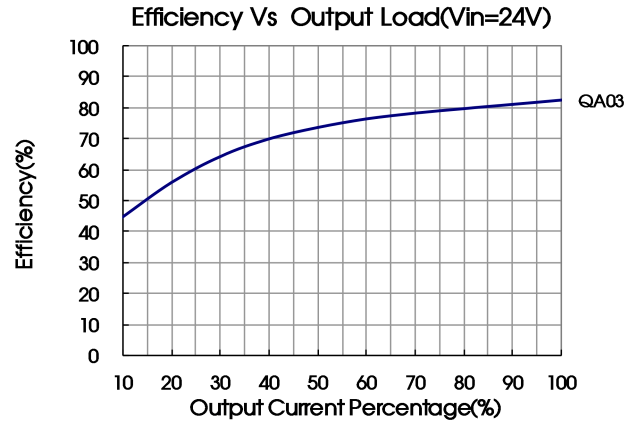
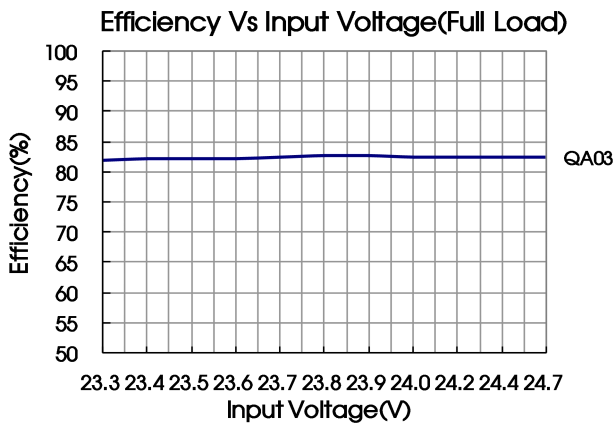
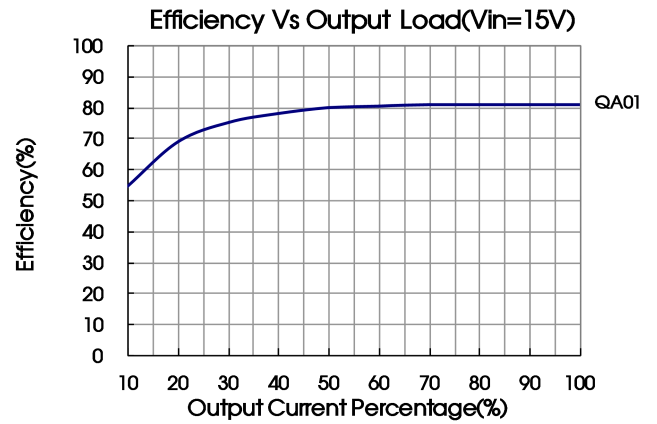
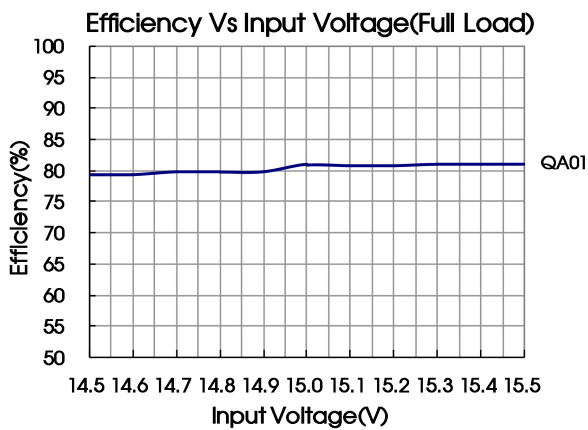
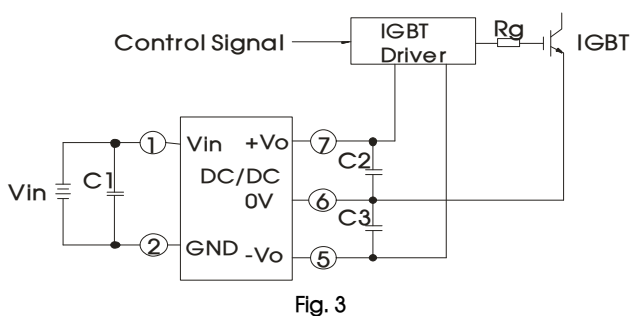

Fig. 2



Design Reference

1. Typical application



C1/ C2 /C3
100uF/35V (Low internal resistance capacitance)

Note: On both ends of capacitance C2 and C3 shunt respectively a capacitance value in 1uF -10uF ceramic capacitors.

2. EMC solution-recommended circuit (CLASS B)

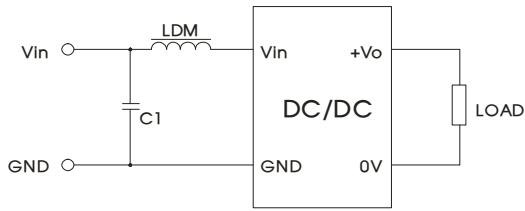

Fig. 4

	Input voltage (VDC)	12/15/24
EMI	C1	4.7μF /50V
	LDM	12μH

3. It is not allowed to connect modules output in parallel to enlarge the power

4. For more information please find DC-DC converter application notes on www.mornsun-power.com

Dimensions and Recommended Layout

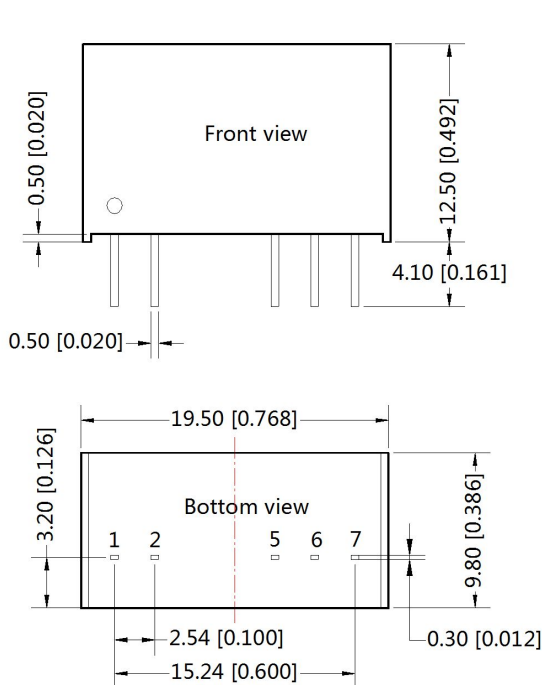

Note:
Unit :mm[inch]
Pin section tolerances:±0.10[±0.004]
General tolerances:±0.50[±0.020]

THIRD ANGLE PROJECTION

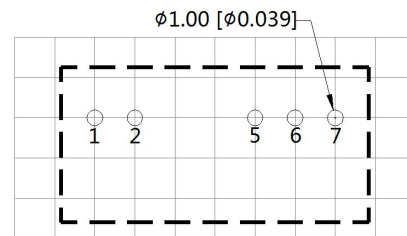

Note:Grid 2.54*2.54mm

Pin-Out	
Pin	Function
1	Vin
2	GND
5*	-Vo
6	0V
7	+Vo

Note:*QA01-09 has no connection

Notes:

1. Packing information please refer to Product Packing Information which can be downloaded from www.mornsun-power.com. Packing bag number: 58200013;
2. The lead wire connecting the power supply module and IGBT driver should be as short as possible during use;
3. The output filtering capacitor should be as close as possible to the power supply module and IGBT driver;
4. The peak of the IGBT driver gate drive current is high, so low internal resistance electrolytic capacitor is recommended to be used for the power supply module output filter capacitor;
5. The average output power of the driver must be lower than that of the power supply module;
6. Consider fixing in place with glue near the module if being used in vibration occasions;
7. The maximum capacitive load offered were tested at nominal input voltage and full load;
8. Unless otherwise specified, parameters in this datasheet were measured under the conditions of $T_a=25^{\circ}\text{C}$, humidity<75% with nominal input voltage and rated output load;
9. All index testing methods in this datasheet are based on our Company's corporate standards;
10. The performance parameters of the product models listed in this manual are as above, but some parameters of non-standard model products may exceed the requirements mentioned above. Please contact our technicians directly for specific information;
11. We can provide product customization service;
12. Specifications are subject to change without prior notice.

MORNSUN Guangzhou Science & Technology Co., Ltd.

Address: No. 5, Kehui St. 1, Kehui Development Center, Science Ave., Guangzhou Science City, Luogang District, Guangzhou, P. R. China
Tel: 86-20-38601850-8801 Fax: 86-20-38601272 E-mail: info@mornsun.cn