



WFP8N60

600V N-Channel MOSFET

Features

- Low Intrinsic Capacitances
- Excellent Switching Characteristics
- Extended Safe Operating Area
- Unrivalled Gate Charge :Qg= 40nC (Typ.)
- BVDSS=600V, ID=7.5A
- R_{DS(on)} :1.32 Ω (Max) @VG=10V
- 100% Avalanche Tested

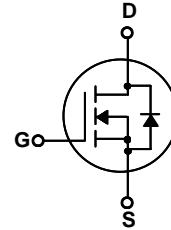
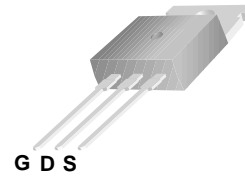

TO-220

G-Gate, D-Drain, S-Source

Absolute Maximum Ratings *T_c=25°C unless other wise noted*

Symbol	Parameter	WFP8N60	Units
V _{DSS}	Drain-Source Voltage	600	V
I _D	Drain Current -continuous (T _c =25°C)	7.5	A
	-continuous (T _c =100°C)	4.7	A
V _{GS}	Gate-Source Voltage	± 30	V
E _{AS}	Single Plused Avanche Energy (Note1)	420	mJ
I _{AR}	Avalanche Current (Note2)	7	A
P _D	Power Dissipation (T _c =25°C)	147	W
T _J , T _{STG}	Operating and Storage Temperature Range	-55 ~ +150	°C
TL	Maximum lead temperature for soldering purpose, 1/8" from case for 5 seconds	300	°C

Thermal Characteristics

Symbol	Parameter	Typ.	Max	Units
R _{θJC}	Thermal Resistance, Junction to Case	--	0.88	°C/W
R _{θCS}	Thermal Resistance, Case to Sink	0.5	--	°C/W
R _{θJA}	Thermal Resistance, Junction to Ambient	--	62.5	°C/W

Electrical Characteristics Tc=25°C unless other wise noted

Symbol	Parameter	Test Condition	Min.	Typ.	Max	Units
--------	-----------	----------------	------	------	-----	-------

Off Characteristics

BV _{DSS}	Drain-Source Breakdown Voltage	ID=250 μ A, VGS=0	600	--	--	V
ΔBV _{DSS} / ΔT _J	Breakdown Voltage Temperature Coefficient	ID=250 μ A, Reference to 25°C	--	0.67	--	V/°C
IDSS	Zero Gate Voltage Drain Current	Vds=600V, Vgs=0V	--	--	10	μ A
		Vds=480V, Tc=125°C			100	μ A
IGSSF	Gate-body leakage Current, Forward	Vgs=+30V, Vds=0V	--	--	100	nA
IGSSR	Gate-body leakage Current, Reverse	Vgs=-30V, Vds=0V	--	--	-100	nA

On Characteristics

V _{GS(th)}	Gate Threshold Voltage	Id=250uA, Vds=Vgs	2	--	4	V
R _{DS(on)}	Static Drain-Source On-Resistance	Id=3.7A, Vgs=10V	--	--	1.32	Ω

Dynamic Characteristics

Ciss	Input Capacitance	VDS=25V, VGS=0, f=1.0MHz	--	1100	1430	pF
Coss	Output Capacitance		--	135	175	pF
Crss	Reverse Transfer Capacitance		--	16	21	pF

Switching Characteristics

Td(on)	Turn-On Delay Time	VDD=300V, ID=7A RG=25 Ω (Note 3,4)	--	30	70	nS
Tr	Turn-On Rise Time		--	80	170	nS
Td(off)	Turn-Off Delay Time		--	65	140	nS
Tf	Turn-Off Fall Time		--	60	130	nS
Qg	Total Gate Charge	VDS=480, VGS=10V, ID=7A (Note 3,4)	--	29	38	nC
Qgs	Gate-Source Charge		--	7	--	nC
Qgd	Gate-Drain Charge			14.5	--	nC

Drain-Source Diode Characteristics and Maximum Ratings

I _S	Maximum Continuous Drain-Source Diode Forward Current		--	--	7.5	A
I _{SM}	Maximum Pulsed Drain-Source Diode Forward Current		--	--	28	A
V _{SD}	Drain-Source Diode Forward Voltage	Id=7A	--	--	1.5	V
trr	Reverse Recovery Time	I _S =7A, V _{GS} =0V	--	320	--	nS
Qrr	Reverse Recovery Charge	di _F /dt=100A/ μ S (Note3)	--	2.4	--	μ C

- *Notes
- 1, L=15.7mH, IAS=7.5A, VDD=50V, RG=25Ω, Starting T_J =25°C
 - 2, Repetitive Rating : Pulse width limited by maximum junction temperature
 - 3, Pulse Test : Pulse Width ≤ 300μs, Duty Cycle ≤ 2%
 - 4, Essentially Independent of Operating Temperature

Typical Characteristics

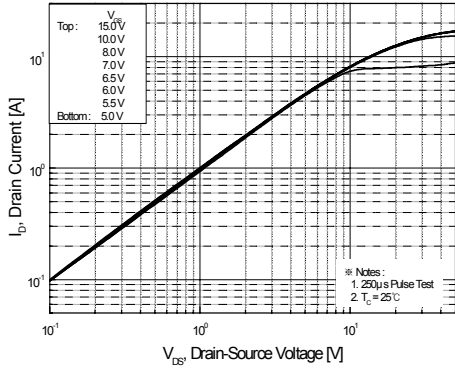

Figure 1. On-Region Characteristics

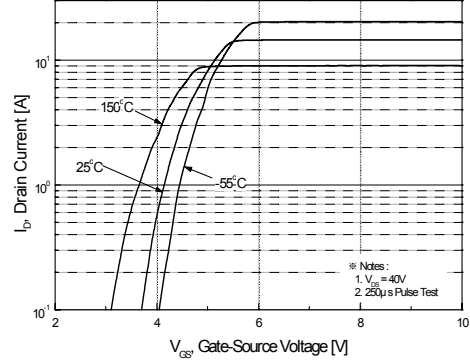

Figure 2. Transfer Characteristics

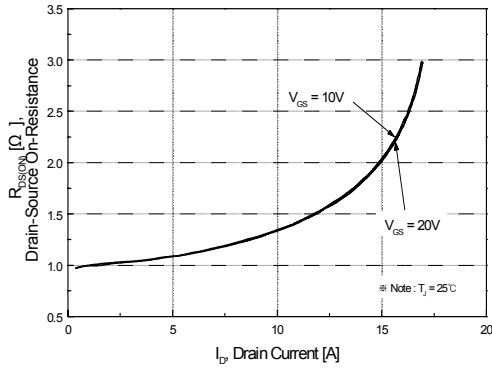

Figure 3. On-Resistance Variation vs Drain Current and Gate Voltage

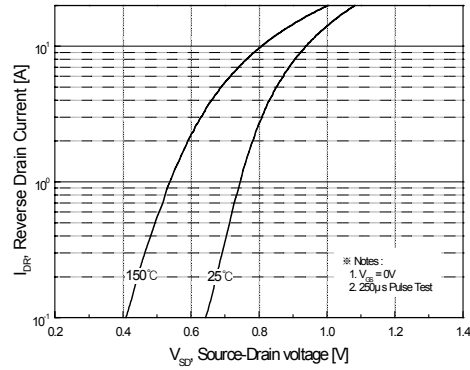

Figure 4. Body Diode Forward Voltage Variation with Source Current and Temperature

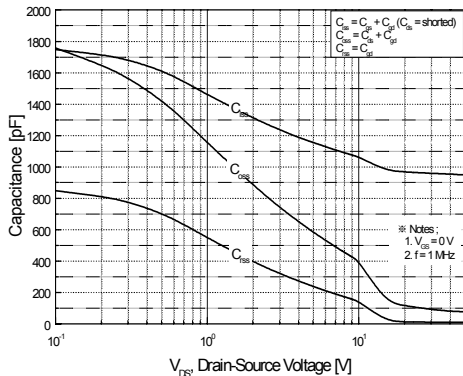

Figure 5. Capacitance Characteristics

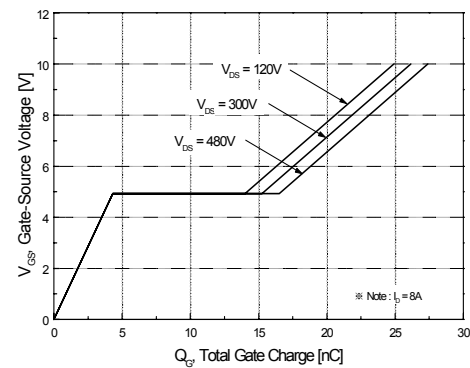

Figure 6. Gate Charge Characteristics

Typical Characteristics (Continued)

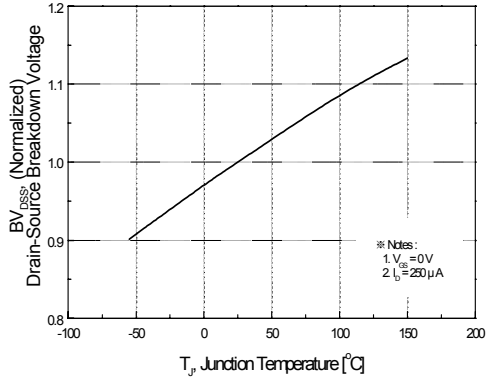

Figure 7. Breakdown Voltage Variation vs Temperature

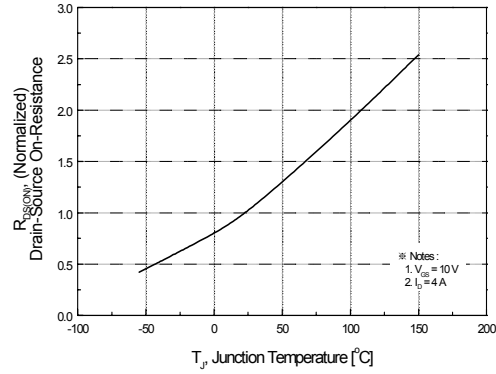

Figure 8. On-Resistance Variation vs Temperature

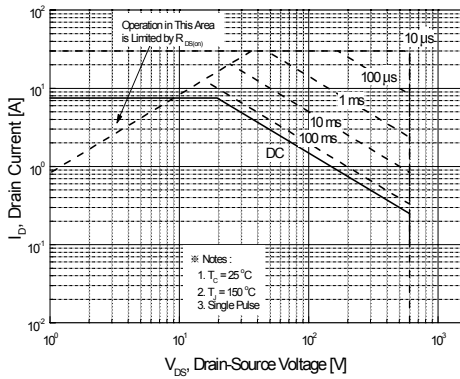

Figure 9-1. Maximum Safe Operating Area for WFP8N60

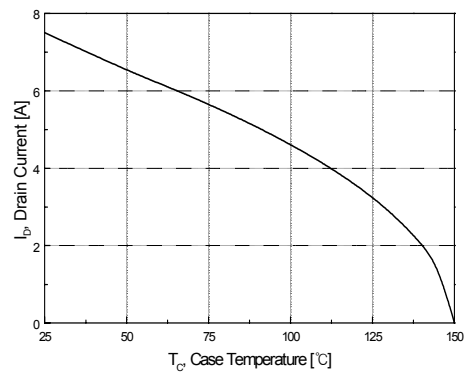

Figure 10. Maximum Drain Current vs Case Temperature

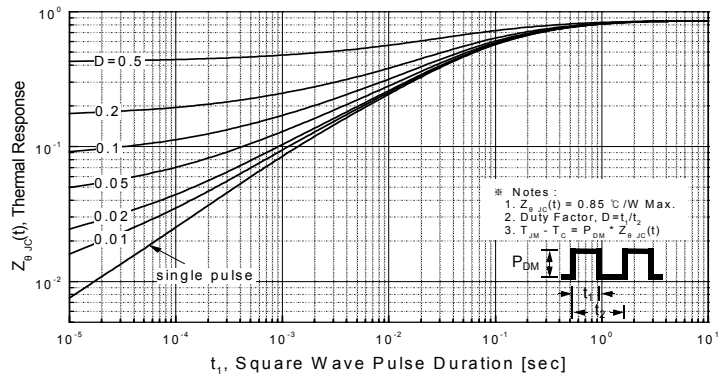
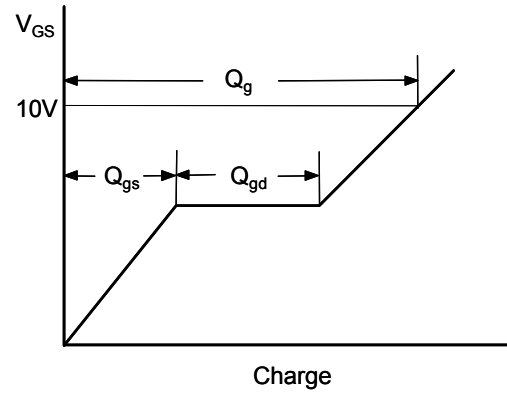
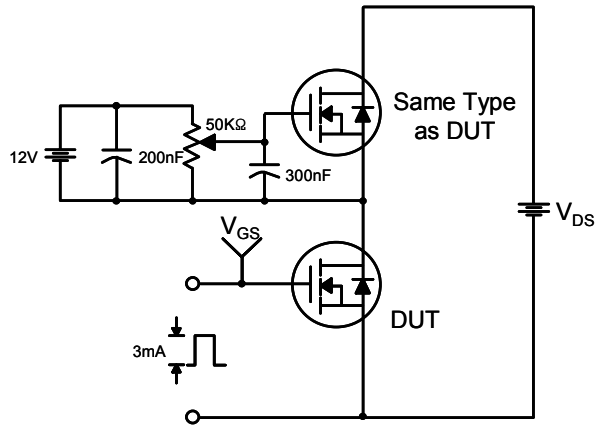
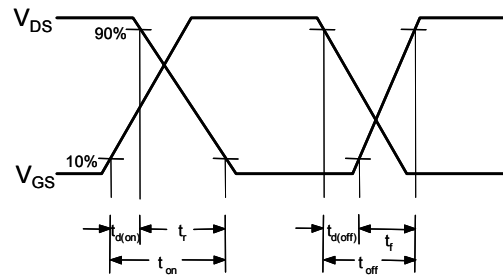
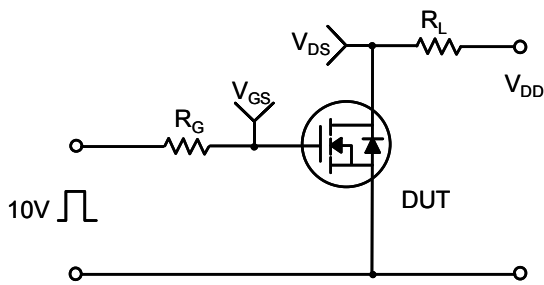

Figure 11-1. Transient Thermal Response Curve for WFP8N60

Gate Charge Test Circuit & Waveform



Resistive Switching Test Circuit & Waveforms



Unclamped Inductive Switching Test Circuit & Waveforms

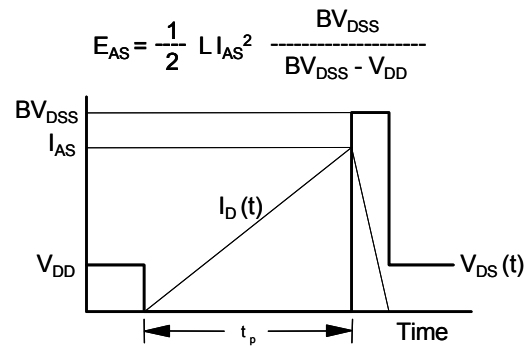
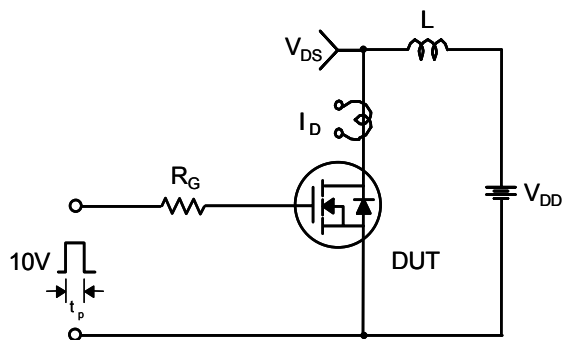

Peak Diode Recovery dv/dt Test Circuit & Waveforms

