

PART No. 2CLBW24

for more information visit

www.hammfg.com

Data subject to change without notice

Isometric drawing Not to Scale

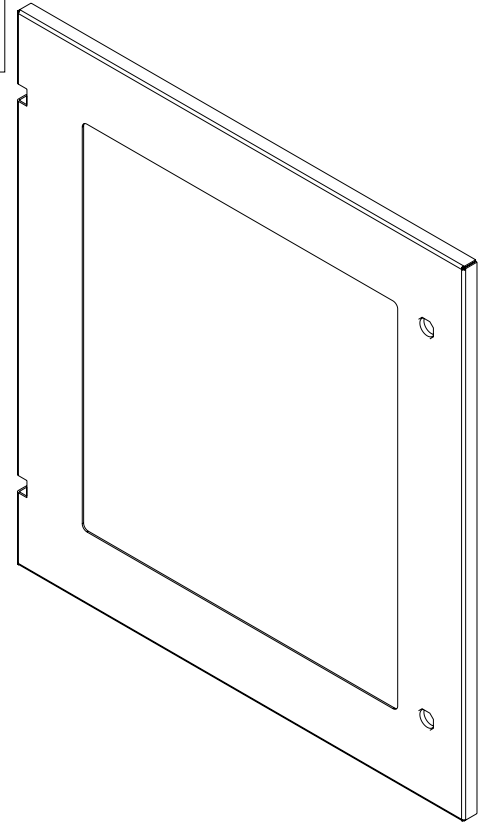
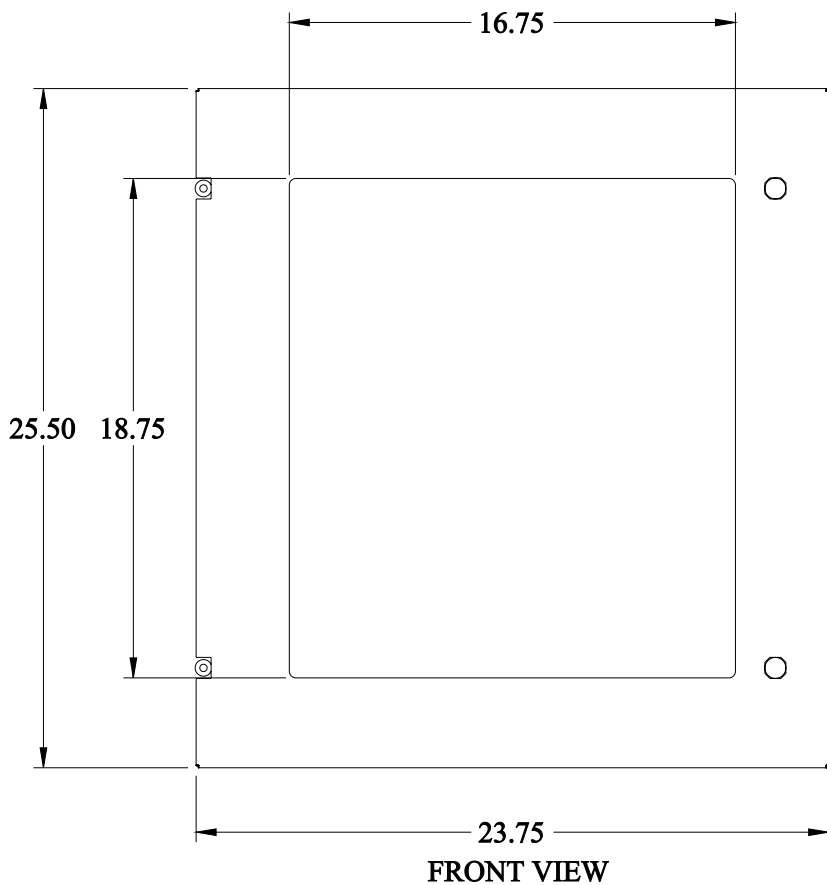

ISOMETRIC VIEW