

## MSW16N50

### 500V N-Channel MOSFET

#### Description

This latest technology has been especially designed to minimize on-state resistance, have a high rugged avalanche characteristics. These devices are well suited for high efficiency switch mode power supplies.

#### Features

- Originative New Design
- Very Low Intrinsic Capacitances
- Excellent Switching Characteristics
- 100% EAS Test
- Extended Safe Operating Area
- RoHS compliant package

#### Application

- High current, High speed switching
- PFC (Power Factor Correction)
- SMPS (Switched Mode Power Supplies)

#### Packing & Order Information

30/Tube ; 540/Box

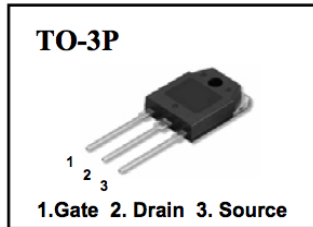
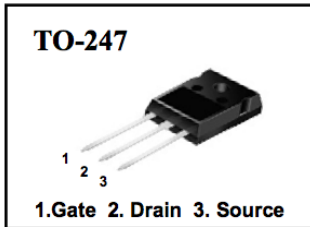

**RoHS**  
COMPLIANT

#### Graphic symbol

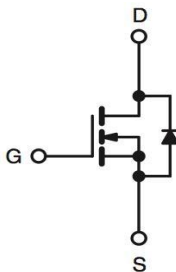

#### TO-247

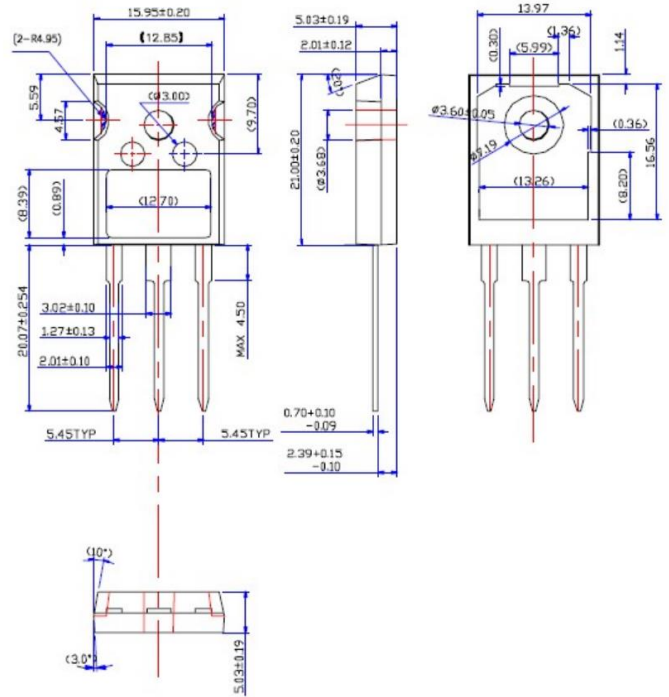

#### TO-3P

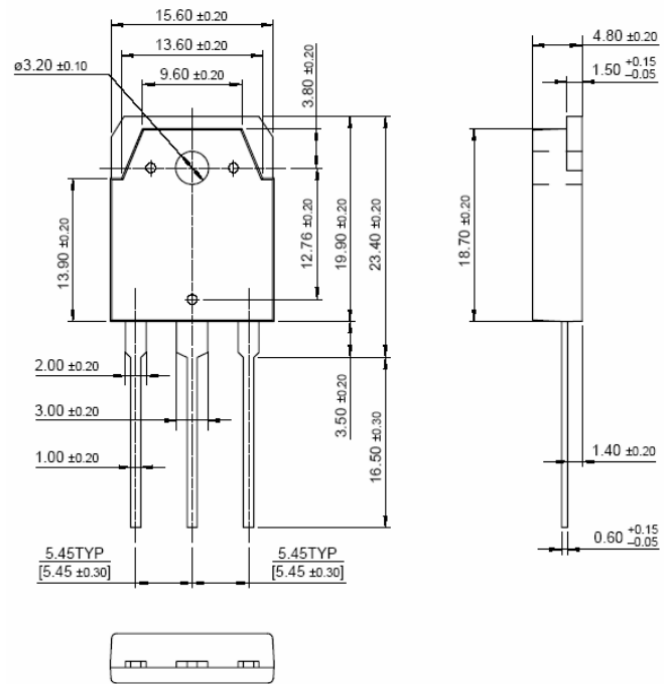

# MSW16N50

## 500V N-Channel MOSFET

### MAXIMUM RATINGS AND ELECTRICAL CHARACTERISTICS

#### Absolute Maximum Ratings (Tc=25°C unless otherwise noted)

Symbol	Parameter	Value	Unit
V <sub>DS</sub>	Drain-Source Voltage	500	V
V <sub>GS</sub>	Gate-Source Voltage	±30	V
I <sub>D</sub>	Drain Current -Continuous (TC=25°C)	16	A
	Drain Current -Continuous (TC=100°C)	10	A
I <sub>DM</sub>	Drain Current Pulsed	64	A
E <sub>AS</sub>	Single Pulsed Avalanche Energy	896	mJ
E <sub>AR</sub>	Repetitive Avalanche Energy	20.5	mJ
P <sub>D</sub>	Power Dissipation (TC = 25 °C)	205	W
	- Derate above 25°C	2.1	W/°C
T <sub>J</sub> , T <sub>STG</sub>	Operating and Storage Temperature Range	-55 to +175	°C

#### Note:

1. Pulse width limited by maximum junction temperature
2. Duty cycle ≤ 1%

#### Thermal Resistance Characteristics

Symbol	Parameter	Max.	Units
R <sub>thjc</sub>	Typical thermal resistance	0.64	°C/W
R <sub>θJA</sub>		40	

#### Static Characteristics

Symbol	Test Conditions	Min	Typ.	Max.	Units
V <sub>GS</sub>	V <sub>DS</sub> = V <sub>GS</sub> , I <sub>D</sub> = 250μA	3.0	--	5.0	V
*R <sub>DS(ON)</sub>	V <sub>GS</sub> = 10 V, I <sub>D</sub> = 8 A	--	0.3	0.38	Ω
BV <sub>DSS</sub>	V <sub>GS</sub> = 0 V, I <sub>D</sub> = 250μA	500	--	--	V
ΔBV <sub>DSS</sub> /ΔT <sub>J</sub>	I <sub>D</sub> = 250μA, Referenced to 25°C	--	0.5	--	V/°C
I <sub>DSS</sub>	V <sub>DS</sub> = 500 V, V <sub>GS</sub> = 0 V	--	--	1	uA
	V <sub>DS</sub> = 400 V, V <sub>GS</sub> = 0 V, V <sub>C</sub> = 125°C	--	--	10	
I <sub>GSS</sub>	V <sub>GS</sub> = ±30	--	--	±100	nA

## MSW16N50

500V N-Channel MOSFET

Dynamic Characteristics					
Symbol	Test Conditions	Min	Typ.	Max.	Units
$t_{d(on)}$	$V_{DS} = 250\text{ V}, I_D = 16\text{ A},$ $R_G = 25\ \Omega$	--	50	115	ns
$t_r$		--	180	396	ns
$t_{d(off)}$		--	130	273	ns
$t_f$		--	100	220	ns
$Q_g$	$V_{DS} = 400\text{ V}, I_D = 16\text{ A},$ $V_{GS} = 10\text{ V}$	--	60	78	nC
$Q_{gs}$		--	14	18	nC
$Q_{gd}$		--	28	36	nC
$C_{ISS}$	$V_{DS} = 25\text{ V}, V_{GS} = 0\text{ V},$ $F = 1.0\text{MHz}$	--	2300	2990	pF
$C_{OSS}$		--	330	429	pF
$C_{RSS}$		--	35	46	pF
$I_S$		--	--	16	A
$I_{SM}$		--	--	64	
$V_{SD}$	$I_S = I_F, V_{GS} = 0\text{ V}$	--	--	1.5	V
$t_{rr}$	$I_S = I_F, diF/dt = 100\text{A}/\mu\text{s}$	--	340	--	ns
$Q_{rr}$		--	3.4	--	uC

### Notes;

1. Repetitive Rating: Pulse width limited by maximum junction temperature
2.  $L = 7\text{mH}, I_{AS} = 16\text{A}, V_{DD} = 50\text{V}, R_G = 25\ \Omega,$  Starting  $T_J = 25^\circ\text{C}$
3.  $I_{SD} \leq 16\text{A}, di/dt \leq 200\text{A}/\mu\text{s}, V_{DD} \leq BV_{DSS},$  Starting  $T_J = 25^\circ\text{C}$
4. Pulse Test: Pulse Width  $\leq 300\ \mu\text{s},$  Duty Cycle  $\leq 2\%$
5. Essentially Independent of Operating Temperature

## MSW16N50

### 500V N-Channel MOSFET

#### Typical Characteristics

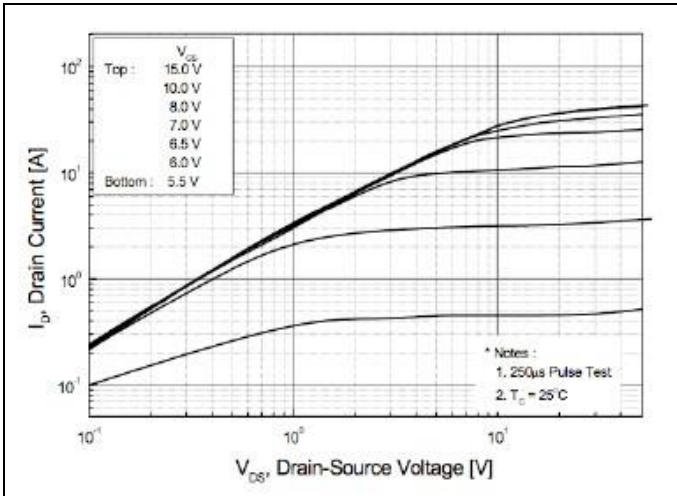

FIG.1-ON REGION CHARACTERISTICS

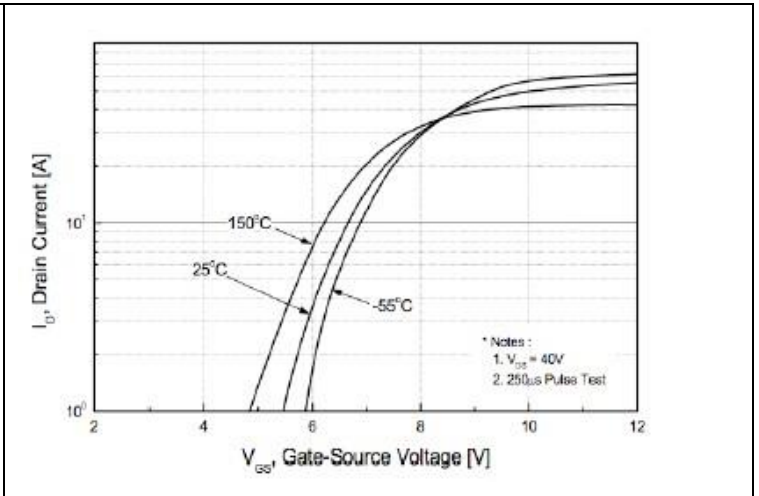

FIG.2-TRANSFER CHARACTERISTICS

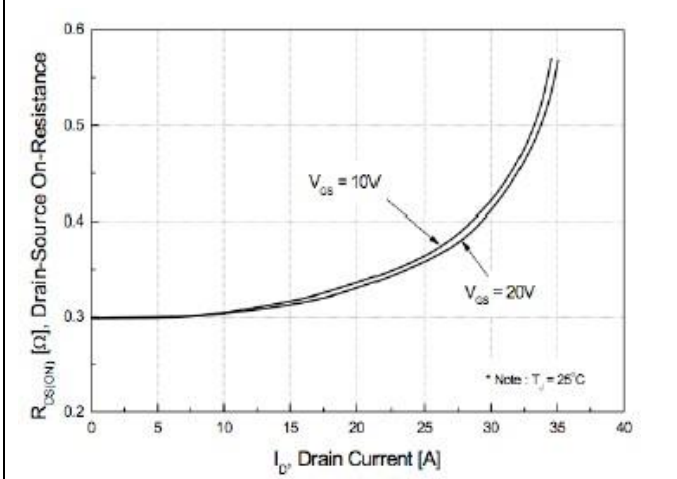

FIG.3-ON RESISTANCE VARIATION VS DRAIN CURRENT AND GATE VOLTAGE

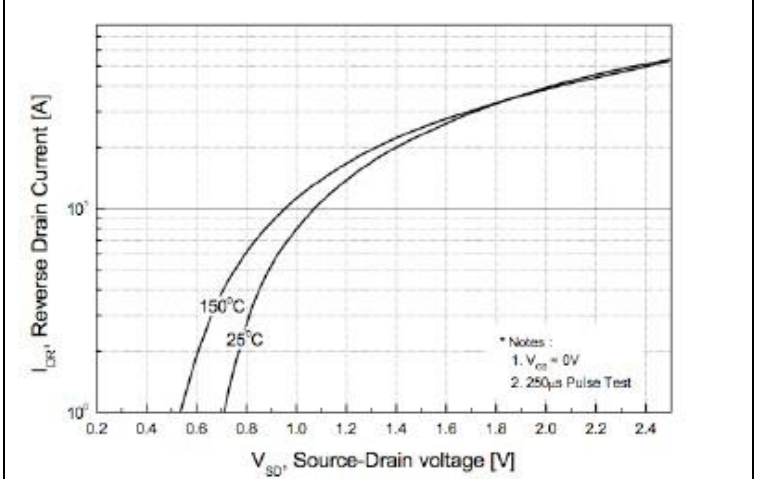

FIG.4-BODY DIODE FORWARD VOLTAGE VARIATION WITH SOURCE CURRENT AND TEMPERATURE

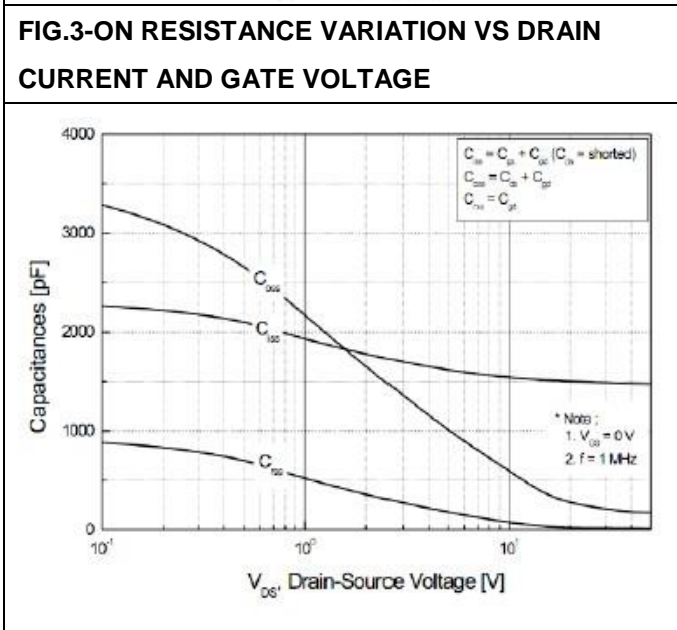

FIG.5-CAPACITANCE CHARACTERISTICS

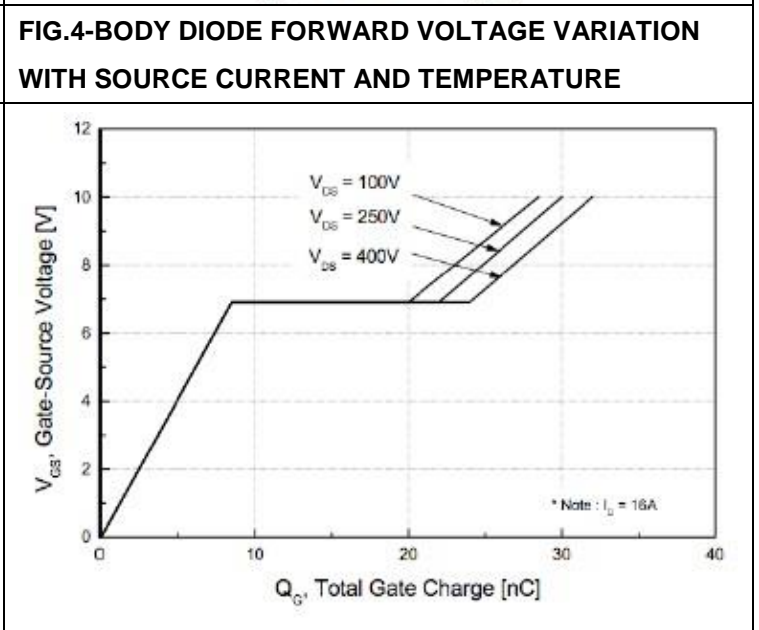
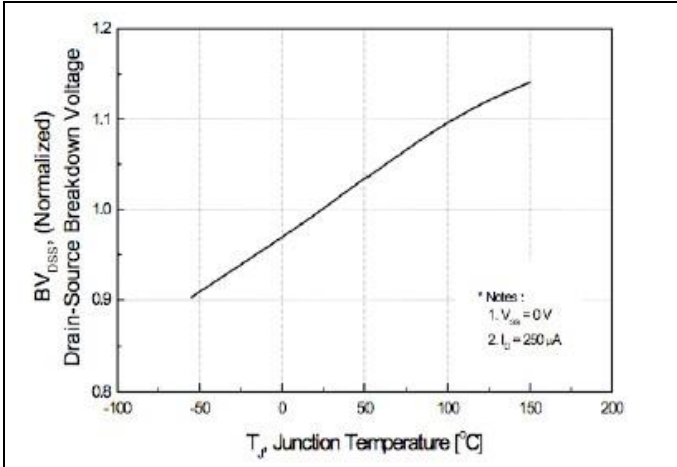

FIG.6-GATE CHARGE CHARACTERISTICS

## MSW16N50

### 500V N-Channel MOSFET

#### ■ Typical Characteristics



**FIG.7-BREAKDOWN VOLTAGE VARIATION VS TEMPERATURE**

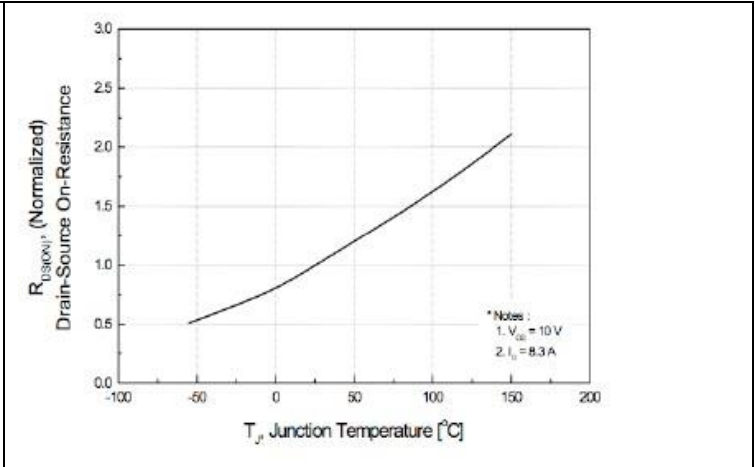

**FIG.8-ON-RESISTANCE VARIATION VS TEMPERATURE**

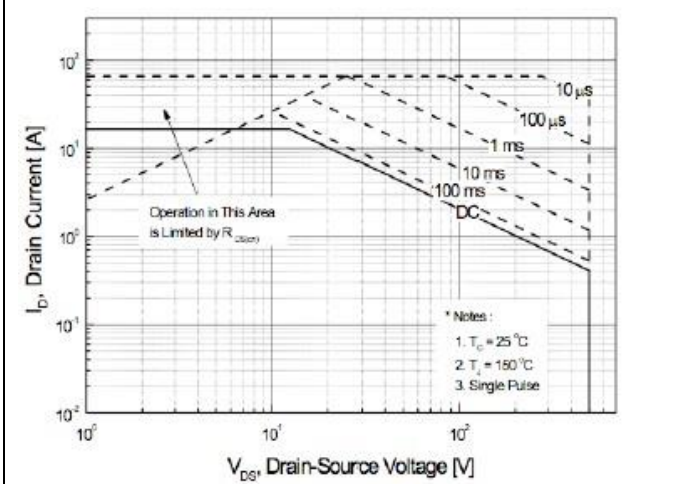

**FIG.9-MAXIMUM SAFE OPERATING AREA**

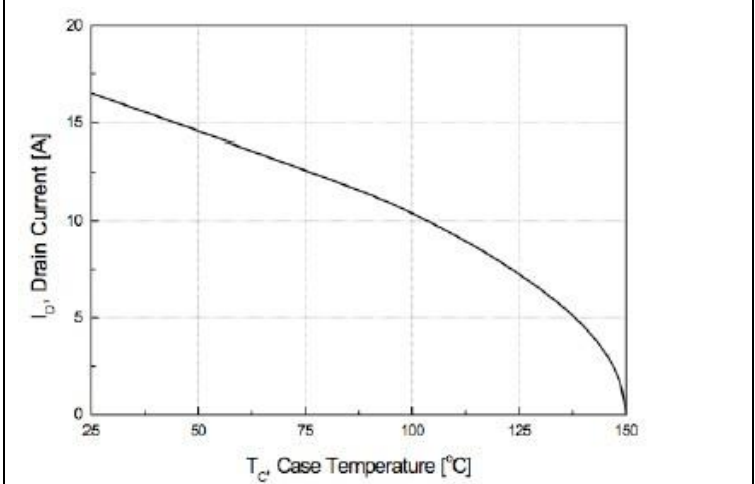

**FIG.10-MAXIMUM DRAIN CURRENT VS CASE TEMPERATURE**

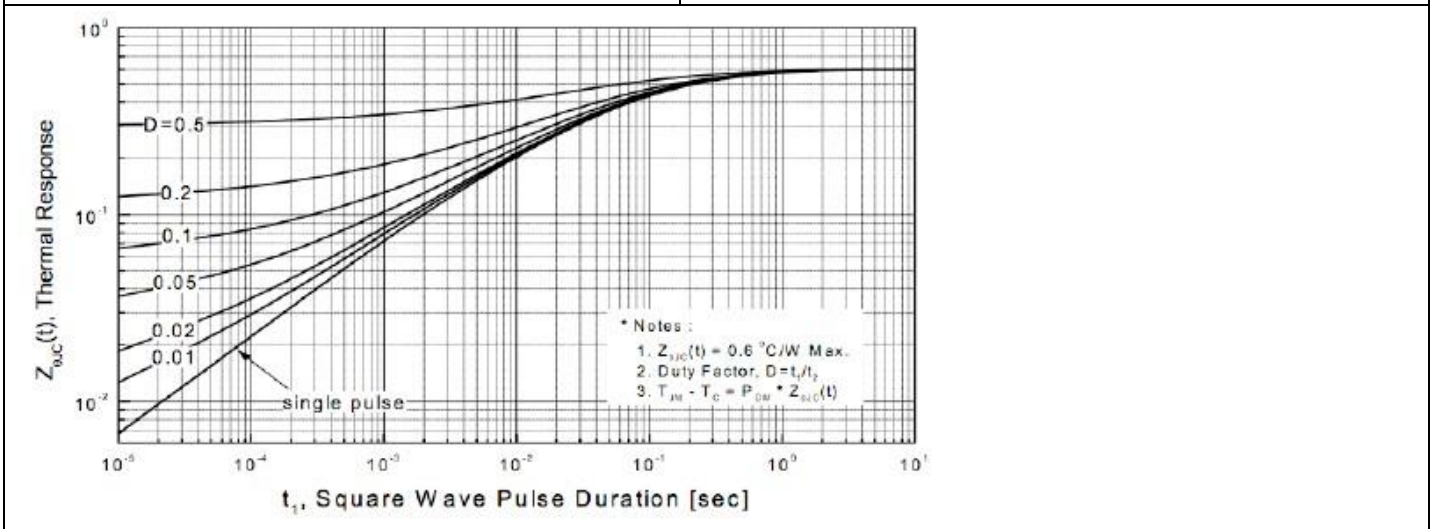

**FIG.11-TRANSIENT THERMAL RESPONSE CURVE**



## MSW16N50

500V N-Channel MOSFET

■ Characteristics Test Circuit & Waveform

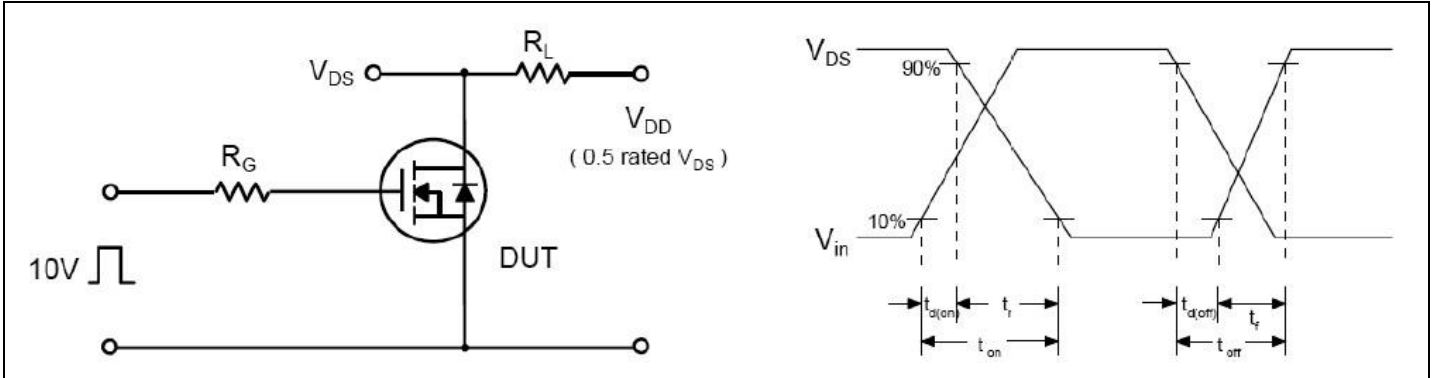

Fig 12. Resistive Switching Test Circuit & Waveforms

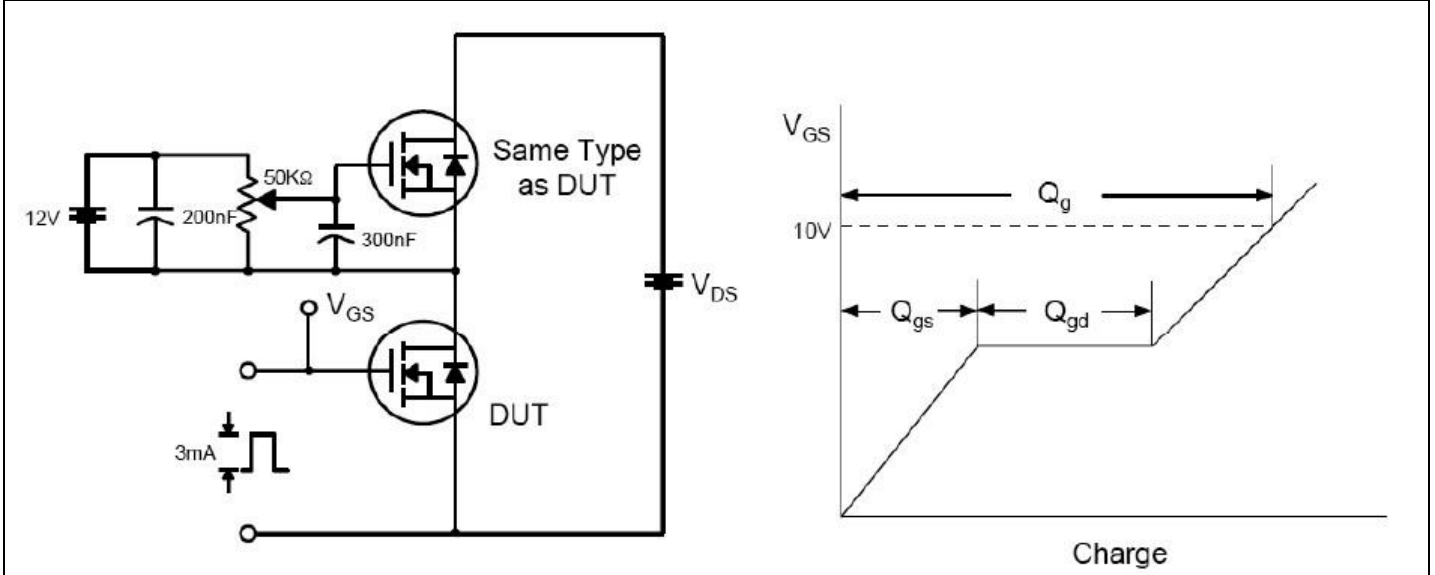

Fig 13. Gate Charge Test Circuit & Waveform

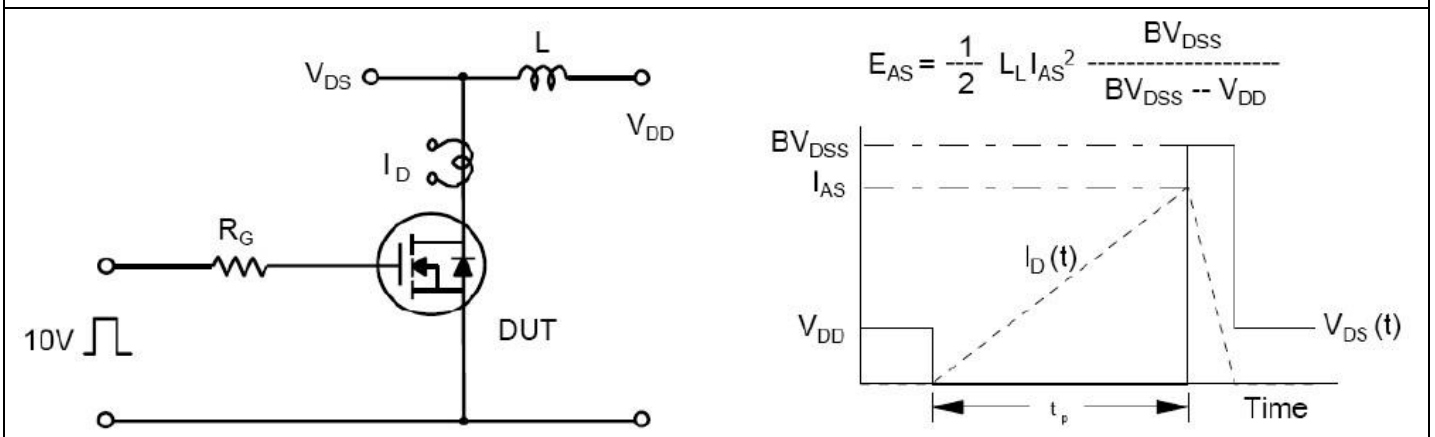

Fig 14. Unclamped Inductive Switching Test Circuit & Waveforms

## MSW16N50

500V N-Channel MOSFET

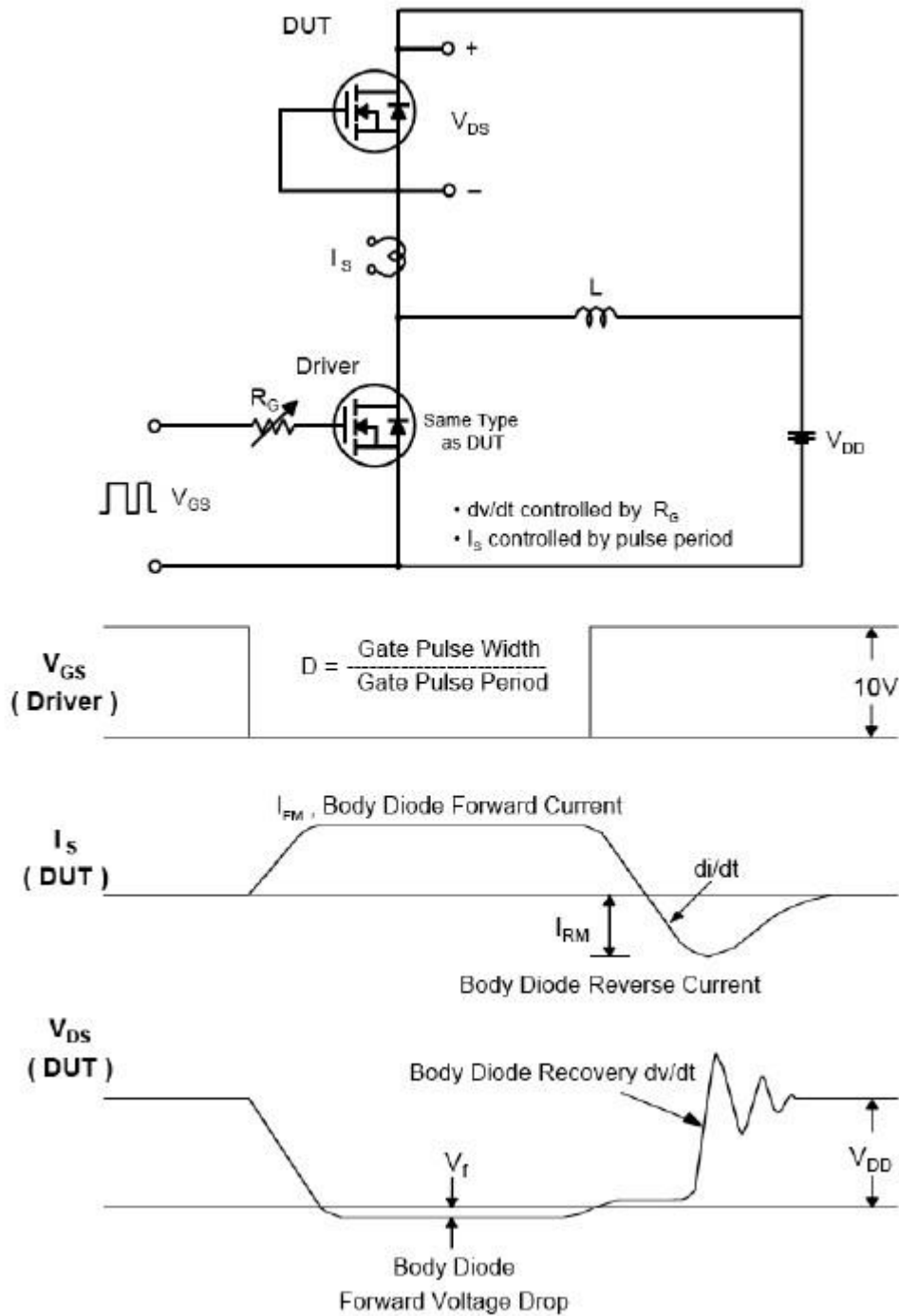

Fig 15. Peak Diode Recovery  $dv/dt$  Test Circuit & Waveforms

## MSW16N50

### 500V N-Channel MOSFET

#### Disclaimer

ALL PRODUCT, PRODUCT SPECIFICATIONS AND DATA ARE SUBJECT TO CHANGE WITHOUT NOTICE TO IMPROVE RELIABILITY, FUNCTION OR DESIGN OR OTHERWISE.

Bruckewell Technology Inc., its affiliates, agents, and employees, and all persons acting on its or their behalf (collectively, "Bruckewell"), disclaim any and all liability for any errors, inaccuracies or incompleteness contained in any datasheet or in any other disclosure relating to any product.

Bruckewell makes no warranty, representation or guarantee regarding the suitability of the products for any particular purpose or the continuing production of any product. To the maximum extent permitted by applicable law, Bruckewell disclaims

- (i) Any and all liability arising out of the application or use of any product.
- (ii) Any and all liability, including without limitation special, consequential or incidental damages.
- (iii) Any and all implied warranties, including warranties of fitness for particular purpose, non-infringement and merchantability.

Statements regarding the suitability of products for certain types of applications are based on Bruckewell's knowledge of typical requirements that are often placed on Bruckewell products in generic applications.

Such statements are not binding statements about the suitability of products for a particular application. It is the customer's responsibility to validate that a particular product with the properties described in the product specification is suitable for use in a particular application. Parameters provided in datasheets and/or specifications may vary in different applications and performance may vary over time.

Product specifications do not expand or otherwise modify Bruckewell's terms and conditions of purchase, including but not limited to the warranty expressed therein.