

Contents

Features	1
Applications	1
Selection Guide	1
Block Diagram	2
Pin Assignment	2
Absolute Maximum Ratings	2
Electrical Characteristics	3
Test Circuits	6
Operation Timing Chart	7
Operation	8
Transient Response	11
Standard Circuit	20
Application Circuits	21
Dimension	23
Markings	23
Taping	24
Characteristics	25

BATTERY BACKUP IC S-8423 Series

Block Diagram

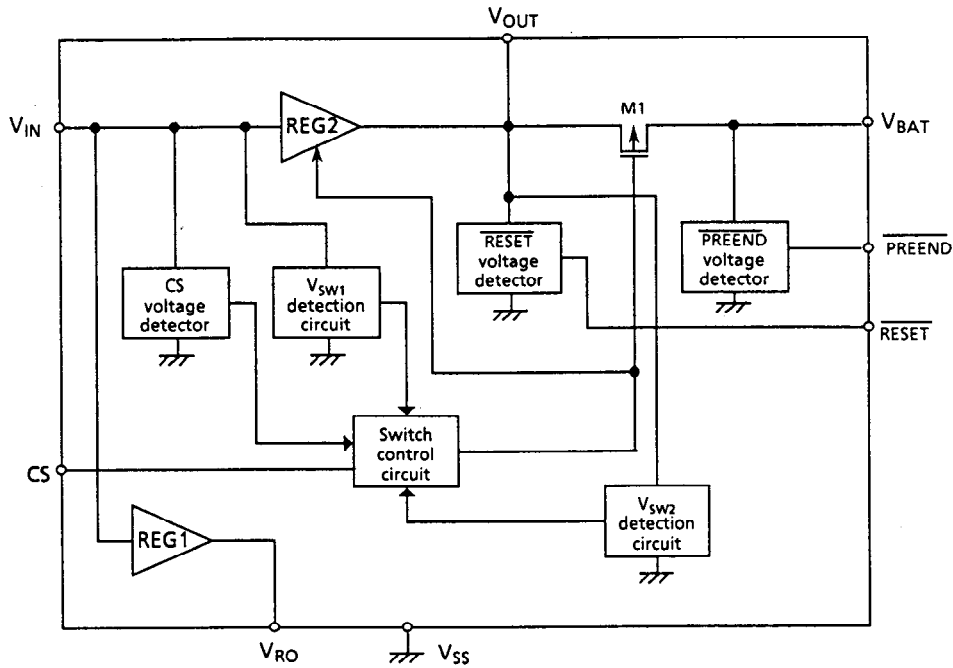
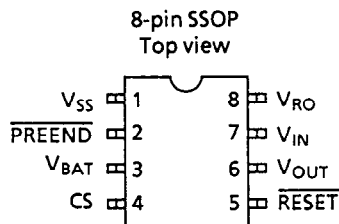

Figure 1

Pin Assignment



Pin name	Functions
CS	Output pin of CS voltage detector
RESET	Output pin of RESET voltage detector
PREEND	Output pin of PREEND voltage detector
VIN*	Primary power supply input pin
VBAT*	Backup power supply input pin
VOUT*	Output pin of voltage regulator 2
VRO*	Output pin of voltage regulator 1
VSS	Ground

* Mount capacitors between VSS (GND) and the VIN, VBAT, VOUT, and VRO pins. (See "Standard Circuit")

Figure 2

Absolute Maximum Ratings

Table 1

Ta = 25°C

Parameter	Symbol	Ratings	Unit	
Primary power supply input voltage	VIN	VSS-0.3 to 17	V	
Backup power supply input voltage	VBAT	VSS-0.3 to 17	V	
Output voltage of voltage regulator	VRO, VOUT	VSS-0.3 to VIN + 0.3	V	
Output voltage of	$\left\{ \begin{array}{l} \text{CS} \\ \text{RESET} \\ \text{PREEND} \end{array} \right.$	$\left\{ \begin{array}{l} V_{CS} \\ V_{RESET} \\ V_{PRE} \end{array} \right.$	VSS-0.3 to 17	V
Power dissipation	PD	300	mW	
Operating temperature	Topr	-40 to +85	°C	
Storage temperature	Tstg	-40 to +125	°C	

Electrical Characteristics

1. S-8423AFS

Table 2

(Unless otherwise specified : Ta = 25°C)

Parameter	Symbol	Conditions	Min.	Typ.	Max.	Unit	Test cir.	
Voltage regulator	Output voltage 1	V_{RO}	$V_{IN} = 6V, I_{RO} = 30mA$	3.23	3.30	3.37	V	1
	I/O voltage difference 1	V_{dif1}	$I_{RO} = 30mA$	—	0.2	0.35	V	
	Load regulation 1	ΔV_{RO1}	$V_{IN} = 6V$ $I_{RO} = 100\mu A \text{ to } 40mA$	—	40	100	mV	
	Line regulation 1	ΔV_{RO2}	$V_{IN} = 6 \text{ to } 16V$ $I_{RO} = 30mA$	—	38	100	mV	
	Temperature coefficient of V_{RO}	$\frac{\Delta V_{RO}}{\Delta Ta}$	$Ta = -40^\circ C \text{ to } 85^\circ C$	—	± 0.47	—	mV/°C	
	Output voltage 2	V_{OUT}	$V_{IN} = 6V, I_{OUT} = 50mA$	3.23	3.30	3.37	V	
	I/O voltage difference 2	V_{dif2}	$I_{OUT} = 50mA$	—	0.2	0.35	V	
	Load regulation 2	ΔV_{OUT1}	$V_{IN} = 6V$ $I_{OUT} = 100\mu A \text{ to } 60mA$	—	50	110	mV	
	Line regulation 2	ΔV_{OUT2}	$V_{IN} = 6 \text{ to } 16V$ $I_{OUT} = 50mA$	—	50	110	mV	
	Temperature coefficient of V_{OUT}	$\frac{\Delta V_{OUT}}{\Delta Ta}$	$Ta = -40^\circ C \text{ to } 85^\circ C$	—	± 0.47	—	mV/°C	
	Input voltage of primary power supply	V_{IN}		—	—	16	V	
Voltage detector	CS detection voltage	$-V_{DET1}$	Detects V_{IN}	3.919	4.000	4.081	V	2
	CS release voltage	$+V_{DET1}$		4.003	4.100	4.197	V	
	RESET detection voltage	$-V_{DET2}$	Detects V_{OUT}	2.253	2.300	2.347	V	
	RESET release voltage	$+V_{DET2}$		2.351	2.420	2.489	V	
	PREEND detection voltage	$-V_{DET3}$	Detects V_{BAT}	$-V_{DET3} + 0.15$	$-V_{DET3} + 0.20$	$-V_{DET3} + 0.25$	V	
	PREEND release voltage	$+V_{DET3}$		$-V_{DET3} + 0.11$	$-V_{DET3} + 0.14$	$-V_{DET3} + 0.17$	V	
	Operating voltage	V_{opr}	V_{IN} or V_{BAT}	2.0	—	16	V	
	Temperature coefficient of detection voltage	$\frac{\Delta -V_{DET1}}{\Delta Ta}$	$Ta = -40^\circ C \text{ to } 85^\circ C$	—	± 0.57	—	mV/°C	
		$\frac{\Delta -V_{DET2}}{\Delta Ta}$	$Ta = -40^\circ C \text{ to } 85^\circ C$	—	± 0.33	—	mV/°C	
		$\frac{\Delta -V_{DET3}}{\Delta Ta}$	$Ta = -40^\circ C \text{ to } 85^\circ C$	—	± 0.36	—	mV/°C	
Sink current	I_{SINK}	$V_{DS} = 0.5V, V_{IN} = V_{BAT} = 2.0V$	RESET	1.50	2.30	—	mA	
			PREEND	1.50	2.30	—	mA	
			CS	1.50	2.30	—	mA	
Leakage current	I_{LEAK}	$V_{DS} = 16V, V_{IN} = 16V$	—	—	0.1	μA	3	
Switch	Switchover voltage	V_{SW1}	$V_{BAT} = 2.8V$ Detects V_{IN}	$+V_{DET1} \times 0.75$	$+V_{DET1} \times 0.77$	$+V_{DET1} \times 0.79$	V	4
	CS output inhibit voltage	V_{SW2}	$V_{BAT} = 3V$ Detects V_{OUT}	$V_{OUT} \times 0.93$	$V_{OUT} \times 0.95$	$V_{OUT} \times 0.97$	V	5
	M1 switch leakage current	I_{LEK}	$V_{IN} = 6V$ $V_{BAT} = 0V$	—	—	1	μA	6
	M1 switch resistance value	R_{SW}	$V_{IN} = \text{open}, V_{BAT} = 3V$ $I_{OUT} = 10 \text{ to } 500\mu A$	—	—	100	Ω	7
	Temperature coefficient of V_{SW1}	$\frac{\Delta V_{SW1}}{\Delta Ta}$	$Ta = -40^\circ C \text{ to } 85^\circ C$	—	± 0.45	—	mV/°C	4
	Temperature coefficient of V_{SW2}	$\frac{\Delta V_{SW2}}{\Delta Ta}$	$Ta = -40^\circ C \text{ to } 85^\circ C$	—	± 0.45	—	mV/°C	5
Current consumption	I_{SS1}	$V_{IN} = 6V, \text{ Unloaded}$	—	28	43	μA	8	
	I_{BAT1}	$V_{BAT} = 3V$	—	0.26	0.50	μA		
	I_{BAT2}	$V_{IN} = \text{open}, V_{BAT} = 3V, \text{ Unloaded}$	$Ta = 25^\circ C$	—	1.0	2.1		μA
			$Ta = 85^\circ C$	—	—	3.5		μA
Input voltage of backup power supply	V_{BAT}		2.0	—	4.0	V	7	

BATTERY BACKUP IC
S-8423 Series

2. S-8423NFS

Table 3

(Unless otherwise specified : Ta = 25°C)

Parameter	Symbol	Conditions	Min.	Typ.	Max.	Unit	Test cir.	
Voltage regulator	Output voltage1	V_{RO}	$V_{IN} = 3.6V, I_{RO} = 15mA$	3.135	3.200	3.265	V	1
	I/O voltage difference 1	V_{dif1}	$I_{RO} = 15mA$	—	60	180	mV	
	Load regulation 1	ΔV_{RO1}	$V_{IN} = 3.6V$ $I_{RO} = 100\mu A \text{ to } 20mA$	—	40	100	mV	
	Line regulation 1	ΔV_{RO2}	$V_{IN} = 3.6 \text{ to } 16V$ $I_{RO} = 15mA$	—	38	100	mV	
	Temperature coefficient of V_{RO}	$\frac{\Delta V_{RO}}{\Delta Ta}$	$Ta = -40^\circ C \text{ to } 85^\circ C$	—	± 0.46	—	mV/°C	
	Output voltage 2	V_{OUT}	$V_{IN} = 3.6V, I_{OUT} = 15mA$	3.135	3.200	3.265	V	
	I/O voltage difference 1	V_{dif2}	$I_{OUT} = 15mA$	—	20	60	mV	
	Load regulation 2	ΔV_{OUT1}	$V_{IN} = 3.6V$ $I_{OUT} = 100\mu A \text{ to } 20mA$	—	50	110	mV	
	Line regulation 2	ΔV_{OUT2}	$V_{IN} = 3.6 \text{ to } 16V$ $I_{OUT} = 15mA$	—	50	110	mV	
	Temperature coefficient of V_{OUT}	$\frac{\Delta V_{OUT}}{\Delta Ta}$	$Ta = -40^\circ C \text{ to } 85^\circ C$	—	± 0.46	—	mV/°C	
	Input voltage of primary power supply	V_{IN}		—	—	16	V	
Voltage detector	CS detection voltage	$-V_{DET1}$	Detects V_{IN}	3.234	3.300	3.366	V	2
	CS release voltage	$+V_{DET1}$		3.315	3.400	3.485	V	
	RESET detection voltage	$-V_{DET2}$	Detects V_{OUT}	2.351	2.400	2.449	V	
	RESET release voltage	$+V_{DET2}$		2.457	2.528	2.599	V	
	PREEND detection voltage	$-V_{DET3}$	Detects V_{BAT}	$-V_{DET3} + 0.15$	$-V_{DET3} + 0.20$	$-V_{DET3} + 0.25$	V	
	PREEND release voltage	$+V_{DET3}$		$-V_{DET3} + 0.11$	$-V_{DET3} + 0.14$	$-V_{DET3} + 0.17$	V	
	Operating voltage	V_{opr}	V_{IN} or V_{BAT}	2.0	—	16	V	
	Temperature coefficient of detection voltage	$\frac{\Delta -V_{DET1}}{\Delta Ta}$	$Ta = -40^\circ C \text{ to } 85^\circ C$	—	± 0.47	—	mV/°C	
		$\frac{\Delta -V_{DET2}}{\Delta Ta}$	$Ta = -40^\circ C \text{ to } 85^\circ C$	—	± 0.34	—	mV/°C	
		$\frac{\Delta -V_{DET3}}{\Delta Ta}$	$Ta = -40^\circ C \text{ to } 85^\circ C$	—	± 0.37	—	mV/°C	
Sink current	I_{SINK}	$V_{DS} = 0.5V,$ $V_{IN} = V_{BAT} = 2.0V$	RESET	1.50	2.30	—	mA	3
			PREEND	1.50	2.30	—	mA	
			CS	1.50	2.30	—	mA	
Leakage current	I_{LEAK}	$V_{DS} = 16V, V_{IN} = 16V$	—	—	0.1	μA		
Switch	Switchover voltage	V_{SW1}	$V_{BAT} = 2.8V$ Detects V_{IN}	$+V_{DET1} \times 0.83$	$+V_{DET1} \times 0.85$	$+V_{DET1} \times 0.87$	V	4
	CS output inhibit voltage	V_{SW2}	$V_{BAT} = 3V$ Detects V_{OUT}	$V_{OUT} \times 0.93$	$V_{OUT} \times 0.95$	$V_{OUT} \times 0.97$	V	5
	M1 switch leakage current	I_{LEK}	$V_{IN} = 3.6V$ $V_{BAT} = 0V$	—	—	1	μA	6
	M1 switch resistance value	R_{SW}	$V_{IN} = \text{open},$ $V_{BAT} = 3V$	—	—	100	Ω	7
	Temperature coefficient of V_{SW1}	$\frac{\Delta V_{SW1}}{\Delta Ta}$	$Ta = -40^\circ C \text{ to } 85^\circ C$	—	± 0.41	—	mV/°C	4
	Temperature coefficient of V_{SW2}	$\frac{\Delta V_{SW2}}{\Delta Ta}$	$Ta = -40^\circ C \text{ to } 85^\circ C$	—	± 0.43	—	mV/°C	5
Current consumption	I_{SS1}	$V_{IN} = 3.6V, \text{ Unloaded}$	—	28	43	μA	8	
	I_{BAT1}	$V_{BAT} = 3V$	—	0.26	0.50	μA		
	I_{BAT2}	$V_{IN} = \text{open}$ $V_{BAT} = 3V,$ Unloaded	$Ta = 25^\circ C$	—	1.0	2.1		μA
			$Ta = 85^\circ C$	—	—	3.5		μA
Input voltage of backup power supply	V_{BAT}		2.0	—	4.0	V	7	

3. S-8423LFS

Table 4

(Unless otherwise specified : Ta = 25°C)

Parameter	Symbol	Conditions	Min.	Typ.	Max.	Unit	Test cir.	
Voltage regulator	Output voltage1	V_{RO}	$V_{IN} = 6\text{ V}, I_{RO} = 30\text{ mA}$	4.90	5.00	5.10	V	1
	I/O voltage difference 1	V_{dif1}	$I_{RO} = 30\text{ mA}$	—	0.2	0.35	V	
	Load regulation 1	ΔV_{RO1}	$V_{IN} = 6\text{ V}$ $I_{RO} = 100\text{ }\mu\text{A to } 40\text{ mA}$	—	50	110	mV	
	Line regulation 1	ΔV_{RO2}	$V_{IN} = 6\text{ to } 16\text{ V}$ $I_{RO} = 30\text{ mA}$	—	50	110	mV	
	Temperature coefficient of V_{RO}	$\frac{\Delta V_{RO}}{\Delta T_a}$	$T_a = -40^\circ\text{C to } 85^\circ\text{C}$	—	± 0.71	—	mV/°C	
	Output voltage 2	V_{OUT}	$V_{IN} = 6\text{ V}, I_{OUT} = 50\text{ mA}$	4.90	5.00	5.10	V	
	I/O voltage difference 1	V_{dif2}	$I_{OUT} = 50\text{ mA}$	—	0.2	0.35	V	
	Load regulation 2	ΔV_{OUT1}	$V_{IN} = 6\text{ V}$ $I_{OUT} = 100\text{ }\mu\text{A to } 60\text{ mA}$	—	50	110	mV	
	Line regulation 2	ΔV_{OUT2}	$V_{IN} = 6\text{ to } 16\text{ V}$ $I_{OUT} = 50\text{ mA}$	—	50	110	mV	
	Temperature coefficient of V_{OUT}	$\frac{\Delta V_{OUT}}{\Delta T_a}$	$T_a = -40^\circ\text{C to } 85^\circ\text{C}$	—	± 0.71	—	mV/°C	
	Input voltage of primary power supply	V_{IN}		—	—	16	V	
Voltage detector	CS detection voltage	$-V_{DET1}$	Detects V_{IN}	4.507	4.600	4.693	V	2
	CS release voltage	$+V_{DET1}$		4.609	4.719	4.828	V	
	RESET detection voltage	$-V_{DET2}$	Detects V_{OUT}	2.253	2.300	2.347	V	
	RESET release voltage	$+V_{DET2}$		2.351	2.420	2.489	V	
	PREEND detection voltage	$-V_{DET3}$	Detects V_{BAT}	$-V_{DET3} + 0.15$	$-V_{DET3} + 0.20$	$-V_{DET3} + 0.25$	V	
	PREEND release voltage	$+V_{DET3}$		$-V_{DET3} + 0.11$	$-V_{DET3} + 0.14$	$-V_{DET3} + 0.17$	V	
	Operating voltage	V_{opr}	V_{IN} or V_{BAT}	2.0	—	16	V	
	Temperature coefficient of detection voltage	$\frac{\Delta -V_{DET1}}{\Delta T_a}$	$T_a = -40^\circ\text{C to } 85^\circ\text{C}$	—	± 0.66	—	mV/°C	
		$\frac{\Delta -V_{DET2}}{\Delta T_a}$	$T_a = -40^\circ\text{C to } 85^\circ\text{C}$	—	± 0.33	—	mV/°C	
		$\frac{\Delta -V_{DET3}}{\Delta T_a}$	$T_a = -40^\circ\text{C to } 85^\circ\text{C}$	—	± 0.36	—	mV/°C	
Sink current	I_{SINK}	$V_{DS} = 0.5\text{ V},$ $V_{IN} = V_{BAT} = 2.0\text{ V}$	RESET	1.50	2.30	—	mA	
			PREEND	1.50	2.30	—	mA	
Leakage current	I_{LEAK}	$V_{DS} = 16\text{ V}, V_{IN} = 16\text{ V}$	—	—	0.1	μA	3	
Switch	Switchover voltage	V_{SW1}	$V_{BAT} = 2.8\text{ V}$ Detects V_{IN}	$+V_{DET1} \times 0.75$	$+V_{DET1} \times 0.77$	$+V_{DET1} \times 0.79$	V	4
	CS output inhibit voltage	V_{SW2}	$V_{BAT} = 3\text{ V}$ Detects V_{OUT}	$V_{OUT} \times 0.93$	$V_{OUT} \times 0.95$	$V_{OUT} \times 0.97$	V	5
	M1 switch leakage current	I_{LEK}	$V_{IN} = 6\text{ V}$ $V_{BAT} = 0\text{ V}$	—	—	1	μA	6
	M1 switch resistance value	R_{SW}	$V_{IN} = \text{open},$ $V_{BAT} = 3\text{ V},$ $I_{OUT} = 10\text{ to } 500\text{ }\mu\text{A}$	—	—	100	Ω	7
	Temperature coefficient of V_{SW1}	$\frac{\Delta V_{SW1}}{\Delta T_a}$	$T_a = -40^\circ\text{C to } 85^\circ\text{C}$	—	± 0.51	—	mV/°C	4
	Temperature coefficient of V_{SW2}	$\frac{\Delta V_{SW2}}{\Delta T_a}$	$T_a = -40^\circ\text{C to } 85^\circ\text{C}$	—	± 0.68	—	mV/°C	5
Current consumption	I_{SS1}	$V_{IN} = 6\text{ V},$ Unloaded $V_{BAT} = 3\text{ V}$		—	29	45	μA	8
	I_{BAT1}			—	0.26	0.50	μA	
	I_{BAT2}	$V_{IN} = \text{open},$ $V_{BAT} = 3\text{ V},$ Unloaded	$T_a = 25^\circ\text{C}$	—	1.0	2.1	μA	
Input voltage of backup power supply	V_{BAT}		2.0	—	4.0	V	7	

■ Test Circuit

1.

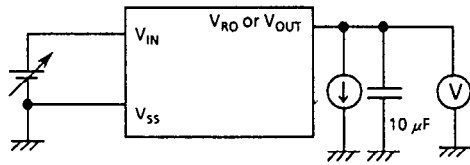

2.

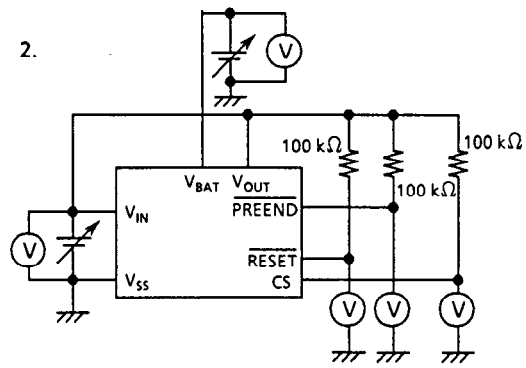

When measuring V_{DET3} , apply 6 V to V_{IN}

3.

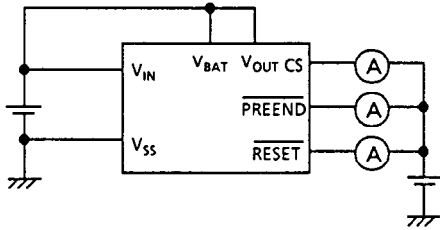

4.

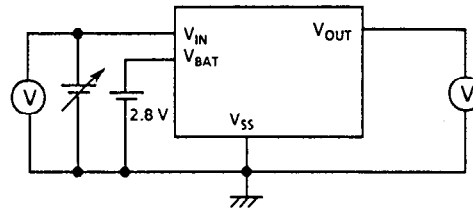

Measure the value after applying 5 V or more to V_{IN}

5.

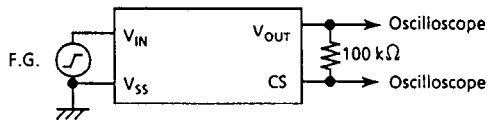

6.

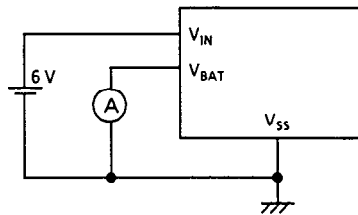

7.

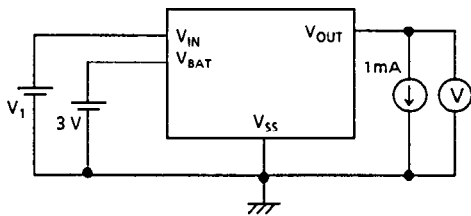

Open and measure the value after applying 6 V to V_1

8.

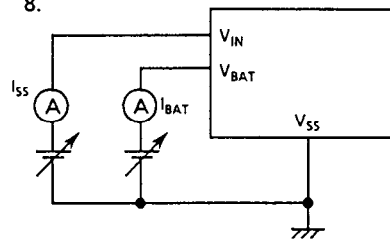

To measure I_{BAT2} , first apply 3 V to V_{BAT} and 6 V or more to V_{IN} . Then open V_{IN} and measure the current when V_{BAT} is 3 V.

Figure 3

■ Operation Timing Chart (S-8423AFS)

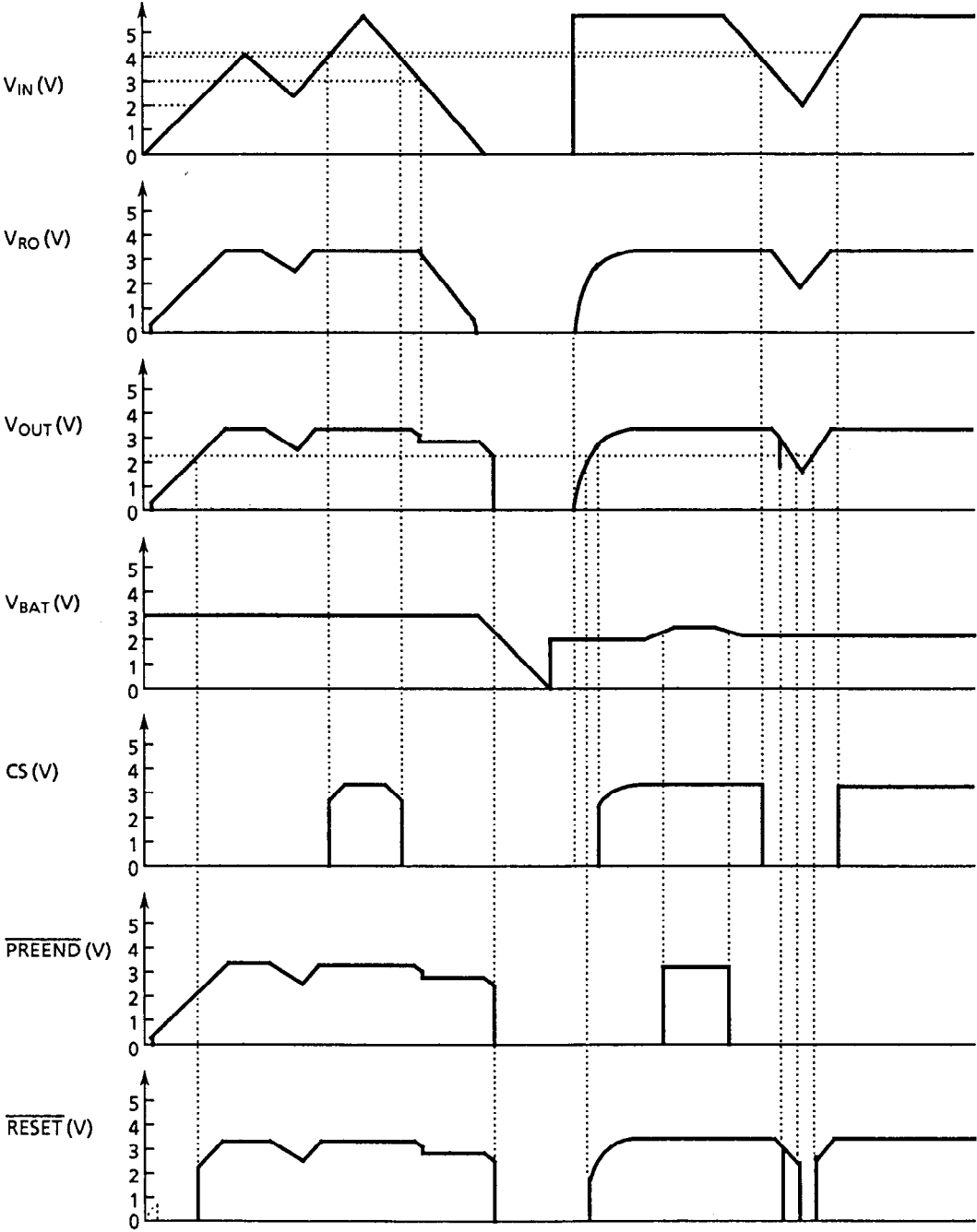

CS, and $\overline{\text{PREEND}}$ and $\overline{\text{RESET}}$ are pulled up to V_{OUT}.

Figure 4

■ **Operation**

The S-8423 Series consists of two voltage regulators, and three voltage detectors. The voltage regulator 1 regulates input voltage V_{IN} and outputs to V_{RO} . The voltage regulator 2 outputs to V_{OUT} . This section describes the functions and operations of each part.

1. Voltage regulators 1 and 2

The built-in regulators have very small I/O voltage difference ($V_{dif1} = 0.2 \text{ V typ. at } I_{RO} = 30 \text{ mA}$). The output voltage of V_{RO} and V_{OUT} can be selected independently between 2.8 and 3.8 V by 0.1 V step.

I/O voltage difference V_{dif1} or V_{dif2}

Assume that the V_{RO} voltage when V_{IN} is 6 V and I_{RO} is 30 mA is $V_{initial}$. When the amount voltage of I/O voltage difference V_{dif1} or V_{dif2} and $V_{initial}$ is applied to the V_{IN} pin, 95% of the $V_{initial}$ voltage is output at the V_{RO} pin.

2. Switch

The switch consists of the switch control circuit, V_{SW1} and V_{SW2} detection circuits, voltage regulator 2 and switch transistor M1.

2.1 V_{SW1} detection circuit

The V_{SW1} detection circuit monitors the V_{IN} voltage and sends the results of detection to the switch control circuit. In the S-8423AFS (CS detection voltage ranges from 4.0 to 5.0 V), detection voltage (V_{SW1}) is set to $77 \pm 2\%$ of CS release voltage $+V_{DET1}$; in the S-8423NFS (CS detection voltage ranges from 3.0 to 4.0 V) is set to $85 \pm 2\%$ of CS release voltage $+V_{DET1}$.

2.2 V_{SW2} detection circuit

V_{SW2} voltage detector monitors V_{OUT} terminal voltage and keeps CS release voltage output low until V_{OUT} terminal voltage rises to V_{SW2} . Then CS output changes from low to high if V_{IN} terminal voltage is more than $+V_{DET1}$ (CS release voltage), when V_{OUT} terminal voltage rises to 95% of V_{OUT2} (output voltage of voltage regulator 2). CS output changes from high to low regardless of V_{SW2} , if V_{IN} terminal voltage falls down to less than $-V_{DET1}$ (CS detection voltage). CS output holds high if V_{IN} terminal voltage keeps higher than $-V_{DET1}$, when V_{OUT} terminal voltage falls down to less than V_{SW2} because of undershoot.

2.3 Switch control circuit

The switch control circuit receives the signal from the V_{SW1} detection circuit and controls M1 and voltage regulator 2. The switch control circuit operates in two statuses: the special and normal sequences. In the special sequence status, the circuit does not receive nor control signals according to the V_{IN} (or V_{BAT}) voltage sequence. In the normal sequence status, the circuit receives and controls signals. Initially, the circuit is kept in the special sequence status. When V_{IN} increases until CS signal goes high, the circuit enters the normal sequence status.

(1) Special sequence status

When the V_{IN} (or V_{BAT}) voltage rises, the switch control circuit is kept in the special sequence status until CS signal goes high.

At that time, the switch control circuit turns voltage regulator 2 on and turns M1 off regardless of the status of the V_{SW1} detection circuit. The voltage regulator 2 has a switchover function.

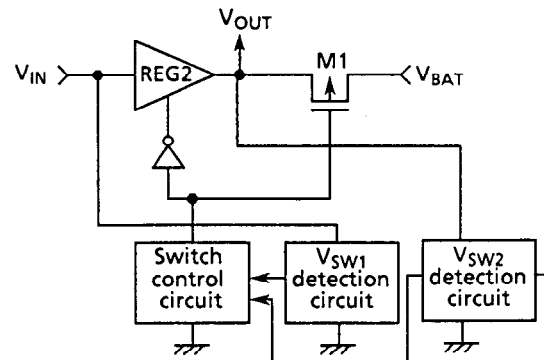

Figure 5 Switch

(2) Normal sequence status

When V_{IN} voltage increases until CS signal, which monitors V_{OUT} terminal, goes high, the switch control circuit enters the normal sequence.

Once the circuit enters the normal sequence, it turns voltage regulator 2 and M1 on and off according to the V_{IN} voltage as shown in Table 5. It takes hundreds μ s in the worst case until voltage regulator 2 goes ON from OFF. During this period, as both voltage regulator 2 and M1 are OFF, V_{OUT} voltage may drop. To protect this drop, do not fail to add 10 μ F or more of capacitor to V_{OUT} terminal.

The circuit returns to the special sequence status, when \overline{RESET} signal goes low.

Table 5

V_{IN} voltage	Voltage regulator 2	M1	V_{OUT}
$V_{IN} > V_{SW1}$	ON	OFF	V_{OUT2}
$V_{IN} < V_{SW1}$	OFF	ON	$V_{BAT} - V_{dif3}$

2.4 Switch transistor M1

Voltage regulator 2 is also used for switch from V_{IN} to V_{OUT} . Therefore, no reverse current flows from V_{OUT} to V_{IN} , when voltage regulator 2 is off.

The output voltage of voltage regulator 2 can be selected between 2.8 V and 3.8 V by 0.1 V step.

The ON resistance of M1 is 100 Ω or less when I_{OUT} is between 10 and 500 μ A.

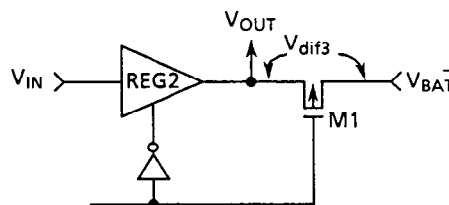

Figure 6 Definitions of V_{dif3}

Therefore, when M1 is turned on to connect V_{OUT} to V_{BAT} , the maximum voltage drop V_{dif3} due to M1 is $100 \times I_{OUT}$ (output current). The minimum output at the V_{OUT} pin is $V_{BAT} - V_{dif3}$ (max.).

When voltage regulator 2 is on and M1 is off, the leakage current of M1 is kept below 1 μ A ($V_{IN} = 6$ V, $T_a = 25^\circ$ C) with the V_{BAT} pin connected to the ground (V_{SS}).

3. Voltage detector

The S-8423 Series has three voltage detectors and V_{SW2} voltage detector. Three detectors feature high precision and low power consumption with hysteresis characteristics. And V_{SW2} voltage detector inhibit CS release output. The power of CS voltage detector is supplied from the V_{IN} and V_{BAT} pins. Therefore, the output is stable as long as the primary or backup power supplies are within the operating voltage range (2 to 16 V). All outputs are Nch open-drains, and need about 100 k Ω of pull-up resistors.

(1) CS voltage detector

CS monitors V_{IN} terminal voltage. The detection voltage can be selected between 3.0 and 5.0 V by 0.1 V step. The result of detection is output at the CS pin: "L" for lower voltages than the detection level and "H" for higher voltages than the release level.

(2) $\overline{\text{PREEND}}$ voltage detector

$\overline{\text{PREEND}}$ monitors the V_{BAT} pin. The detection voltage can be selected between 2.2 V and 2.7 V by 0.1 V step, and also higher than $\overline{\text{RESET}}$ voltage with any difference voltage, indicating that the backup power supply is running out. The result of detection is output at the $\overline{\text{PREEND}}$ pin: "L" for lower voltages than the detection level and "H" for higher voltages than the release level. The power of this detector is supplied from V_{IN} terminal. The output is valid only when voltage is supplied from V_{IN} terminal to V_{OUT} terminal ($V_{\text{IN}} \geq V_{\text{SW1}}$) and the output when voltage is supplied from V_{BAT} terminal to V_{OUT} terminal ($V_{\text{IN}} < V_{\text{SW1}}$) is "L."

(3) $\overline{\text{RESET}}$ voltage detector

$\overline{\text{RESET}}$ monitors the V_{OUT} pin. The detection voltage can be selected between 2.0 V and 2.7 V by 0.1 V step. The result of detection is output at the $\overline{\text{RESET}}$ pin: "L" for lower voltages than the detection level and "H" for higher voltages than the release level. $\overline{\text{RESET}}$ outputs normal logic when V_{OUT} terminal voltage is 1.0 V or more terminal

NOTE $\overline{\text{PREEND}}$ and $\overline{\text{RESET}}$ are detected at different pins. In practice, current is taken from the V_{BAT} side, so consider the I/O voltage difference (V_{diff3}) of M1 when M1 is turned on.

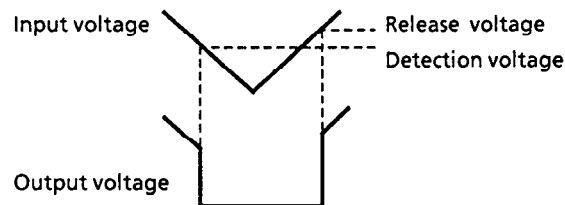

Figure 7 Detection potentials of voltage detectors

■ Transient Response

1. Line transient response against input voltage fluctuation

Input voltage fluctuation differs with the types of the signal applied: type I (square wave between 6.0 V and 10 V) and type II (square wave from 0 V to 10 V) (see Figure 8). This section describes the ringing waveforms and parameter dependency of each type. For reference, Figure 9 describes the measuring circuit.

Type I : Square wave between 6.0 V and 10 V

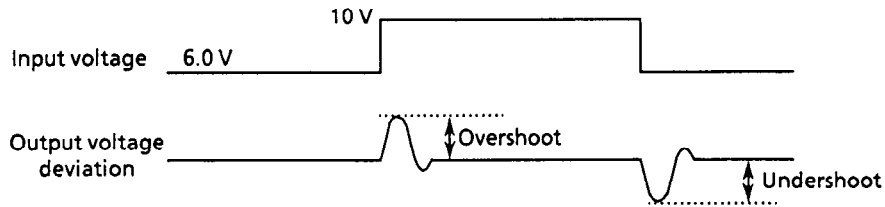

Type II : Square wave from 0 V to 10 V

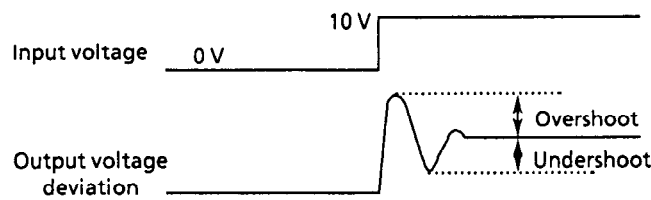

Figure 8

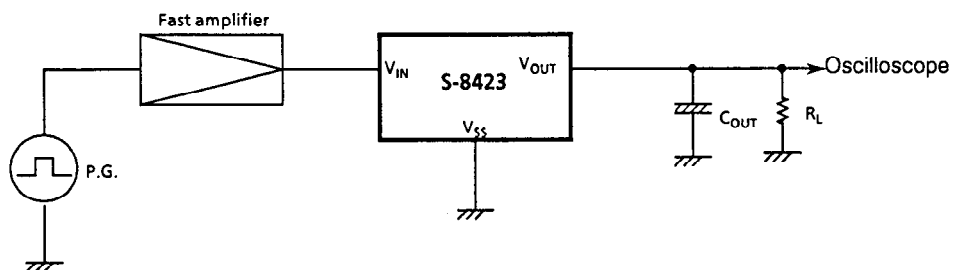

Figure 9 Measuring circuit

Type I

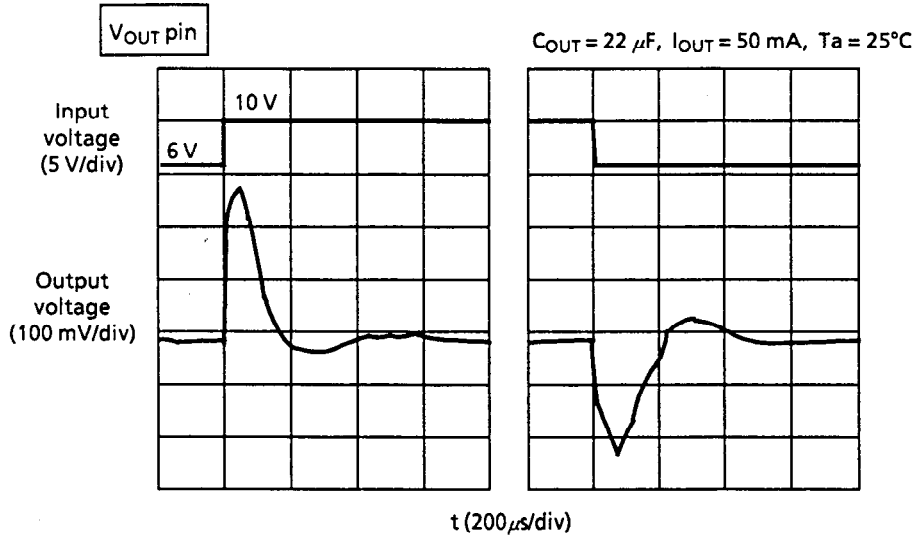

Figure 10 Type I ringing waveform (V_{OUT} pin)

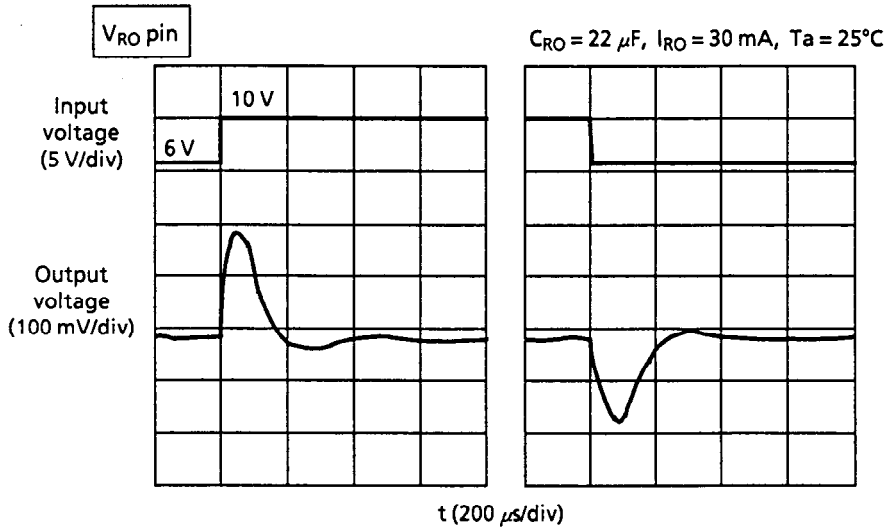

Figure 11 Type I ringing waveform (V_{RO} pin)

Table 6 Type I parameter dependency

Parameter	Conditions	Method to decrease overshoot	Method to decrease undershoot
Output current I_{OUT}	5 to 60 mA	Decrease	Decrease
Load capacitance C_{RO}	5 to 47 μF	Increase	Increase
Input fluctuation ΔV_{IN}	1 to 4 V	Decrease	Decrease
Temperature T_a	-40°C to +85°C	Low temperature	Low temperature

Type II

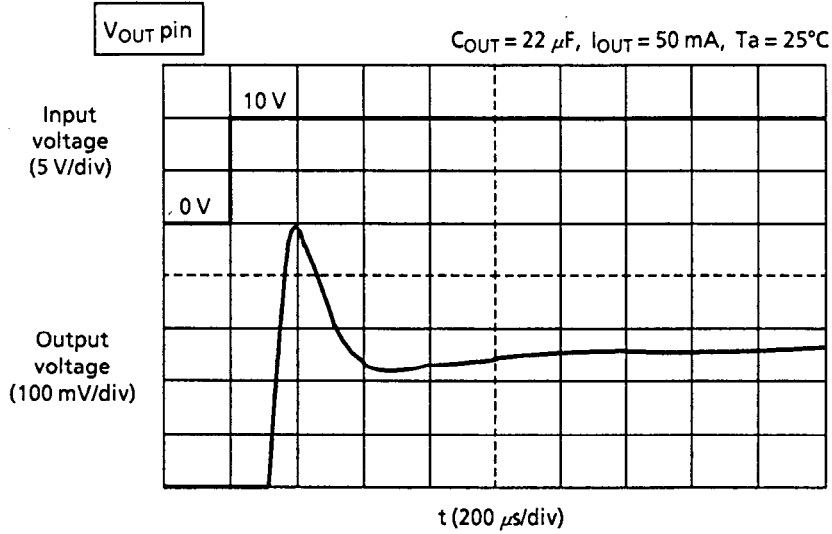

Figure 12 Type II ringing waveform (V_{OUT} pin)

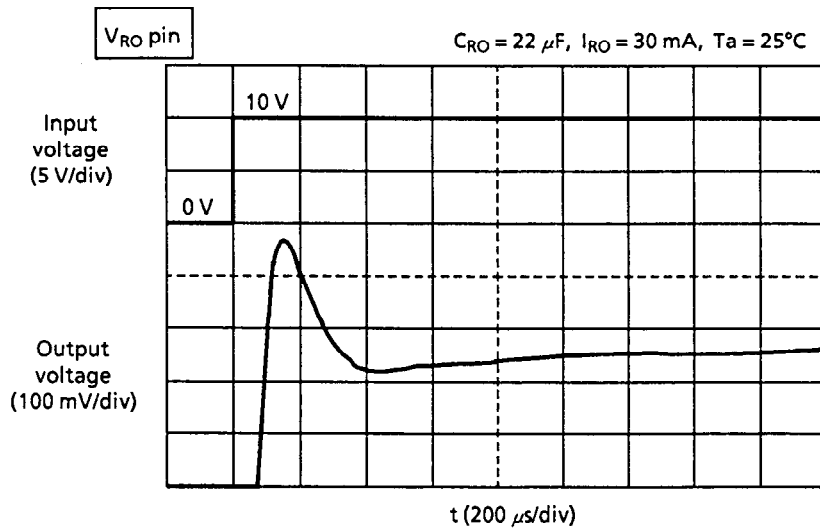

Figure 13 Type II ringing waveform (V_{RO} pin)

Table 7 Type II parameter dependency

Parameter	Conditions	Method to decrease overshoot	Method to decrease undershoot
Output current I _{OUT}	5 to 60 mA	—	—
Load capacitance C _{OUT}	5 to 22 μF	Decrease	Decrease
Load capacitance C _{OUT}	22 to 47 μF	Increase	Increase
Temperature Ta	-40°C to +85°C	Low temperature	Low temperature

For reference, the following pages describe the results of measuring the ringing amounts at the V_{OUT} and V_{RO} pins using the output current (I_{OUT}), load capacitance (C_{RO}), input fluctuation width (ΔV_{IN}), and temperature as parameters.

Reference data: Type I

1. I_{OUT} dependency

1.1 V_{OUT} pin

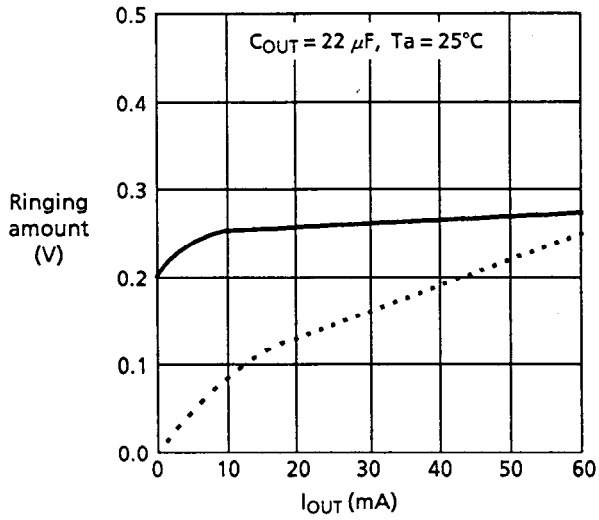

1.2 V_{RO} pin

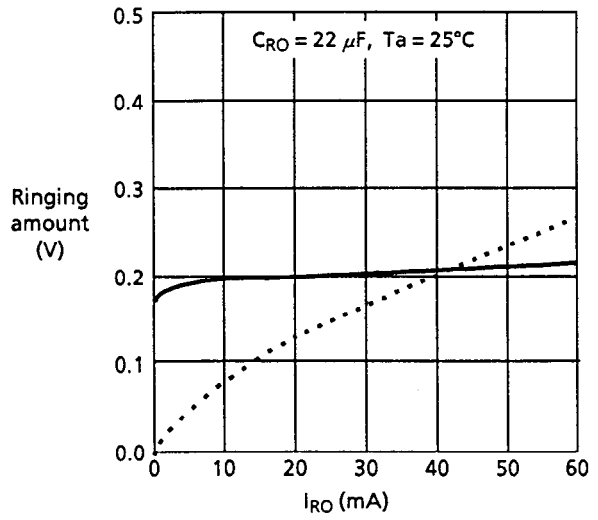

2. C_{RO} dependency

2.1 V_{OUT} pin

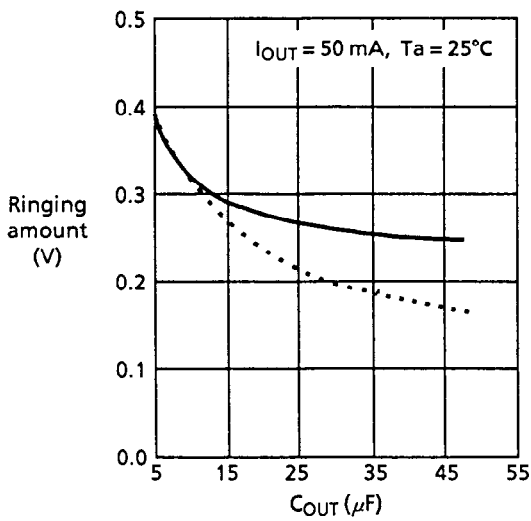

2.2 V_{RO} pin

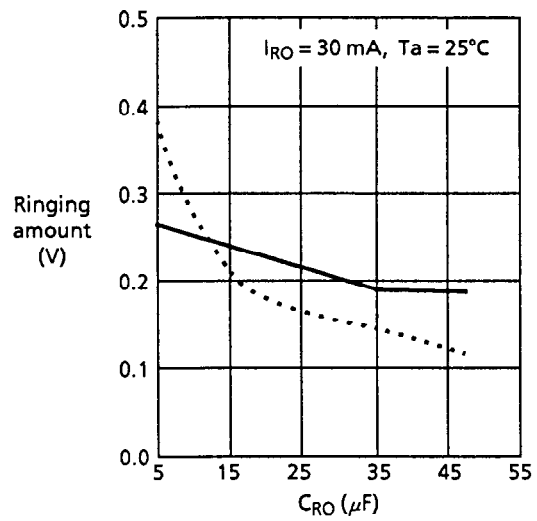

— Overshoot
 Undershoot

3. ΔV_{IN} dependency

ΔV_{IN} shows the difference between the low voltage fixed to 6 V and the high voltage. For example, $\Delta V_{IN} = 2$ V means the difference between 6 V and 8 V.

3.1 V_{OUT} pin

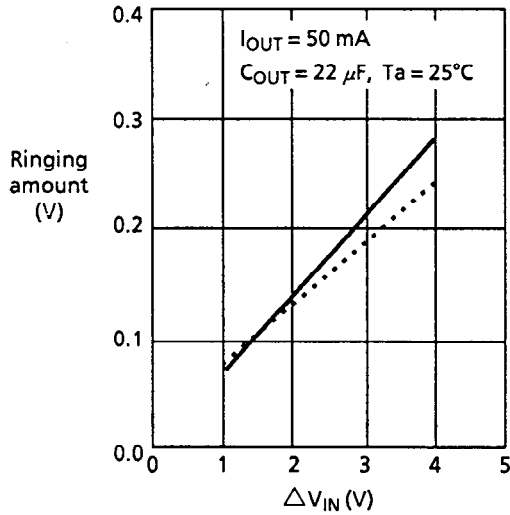

3.2 V_{RO} pin

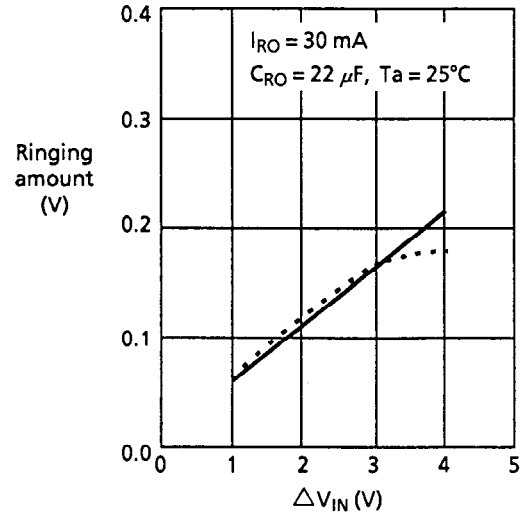

4. Temperature dependency

4.1 V_{OUT} pin

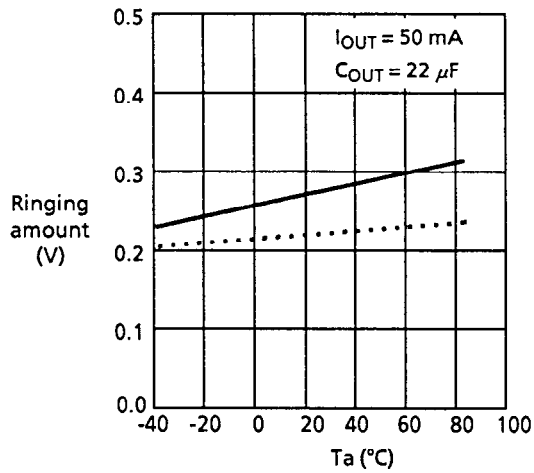

4.2 V_{RO} pin

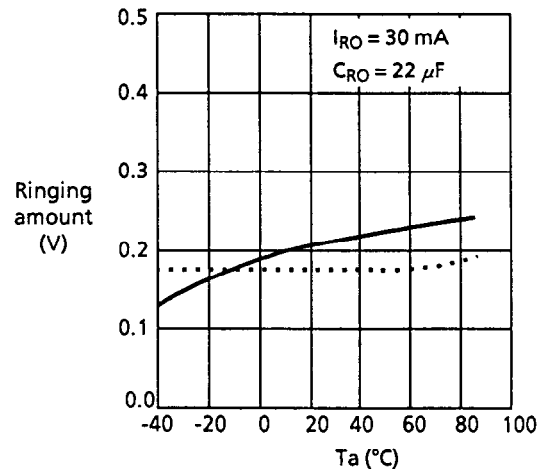

— Overshoot
- - - Undershoot

Reference data: Type II

1. I_{OUT} dependency

1.1 V_{OUT} pin

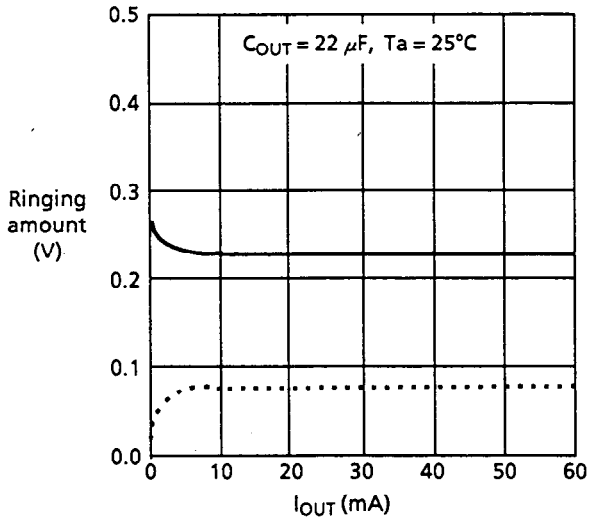

1.2 V_{RO} pin

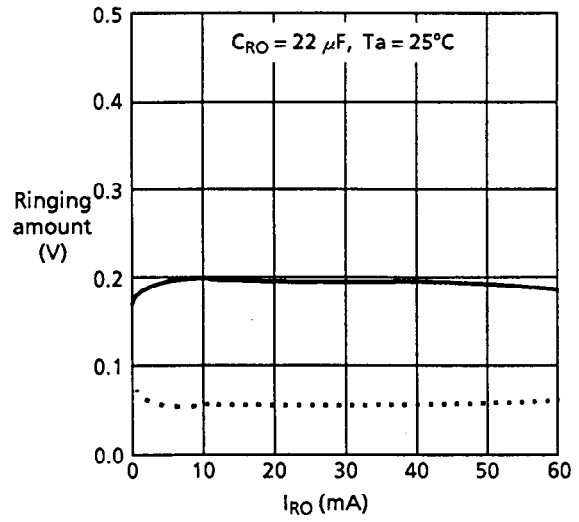

2. C_{RO} dependency

2.1 V_{OUT} pin

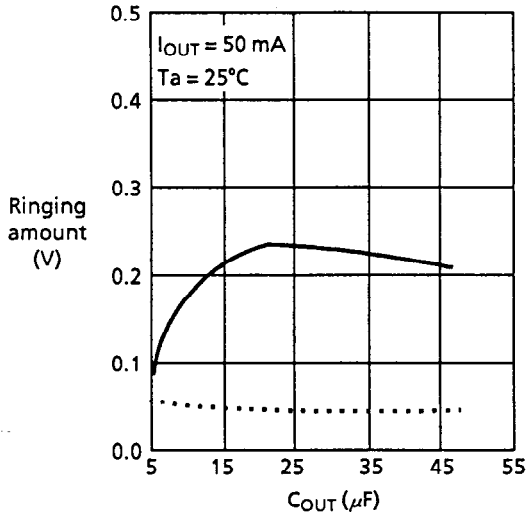

2.2 V_{RO} pin

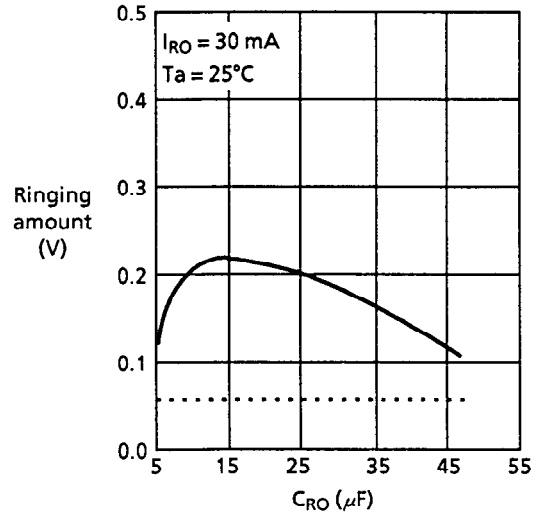

3. Temperature dependency

3.1 V_{OUT} pin

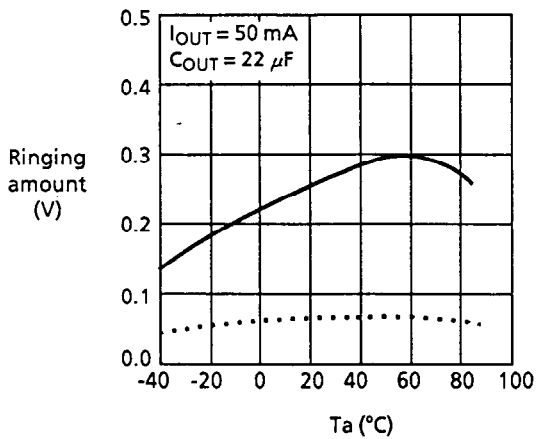

3.2 V_{RO} pin

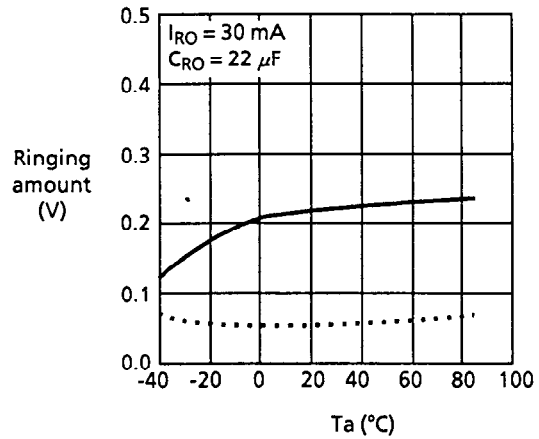

— Overshoot
 Undershoot

2. Load transient response based on output current fluctuation

The overshoot and undershoot are caused in the output voltage if the output current fluctuates between 10 μA and 50 mA (between 10 μA and 30 mA at the V_{RO} pin) while the input voltage is constant. Figure 14 shows the output voltage fluctuation due to change of output current. Figure 15 shows the measuring circuit for reference. The latter half of this section describes ringing waveform and parameter dependency.

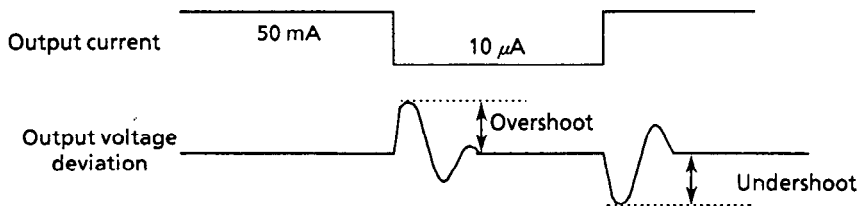

Figure 14

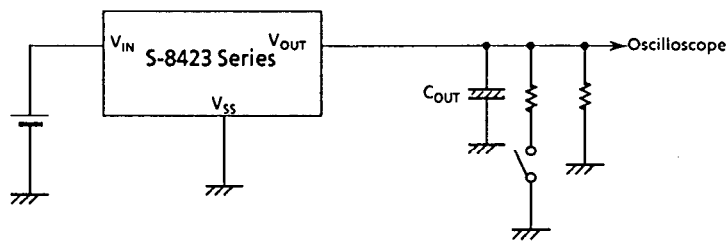

Figure 15 Measuring circuit

Output current fluctuation causes ringing. Figure 18 shows the ringing waveform at the V_{OUT} pin and Figure 19 shows that waveform at the V_{RO} pin.

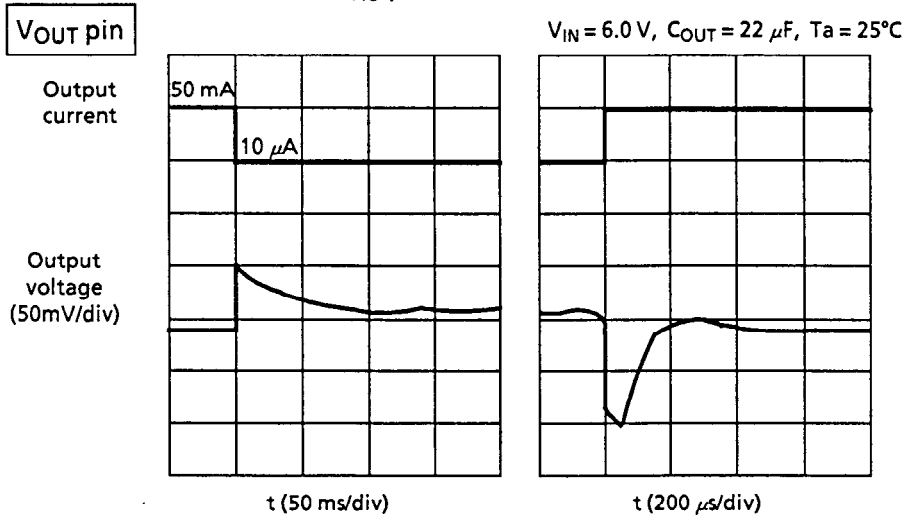

Figure 16 Ringing waveform due to output current fluctuation (V_{OUT} pin)

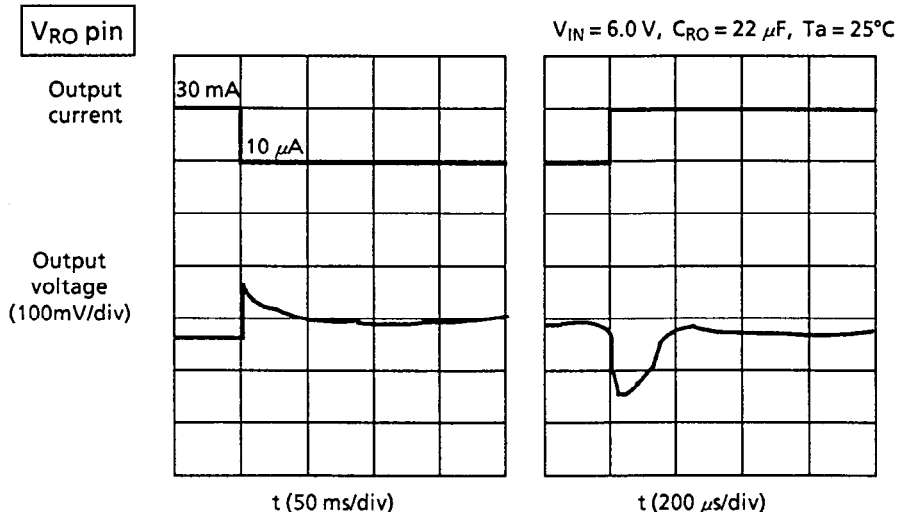

Figure 17 Ringing waveform due to output current fluctuation (V_{RO} pin)

Table 8 Parameter dependency due to output current fluctuation

Parameter	Method to decrease overshoot	Method to decrease undershoot
Input voltage V_{IN}	—	—
Load capacitance C_{RO}	Increase	Increase
Output fluctuation ΔI_{OUT}	Decrease	Decrease
Temperature T_a	Low temperature	Low temperature

Reference data

1. V_{IN} dependency

1.1 V_{OUT} pin

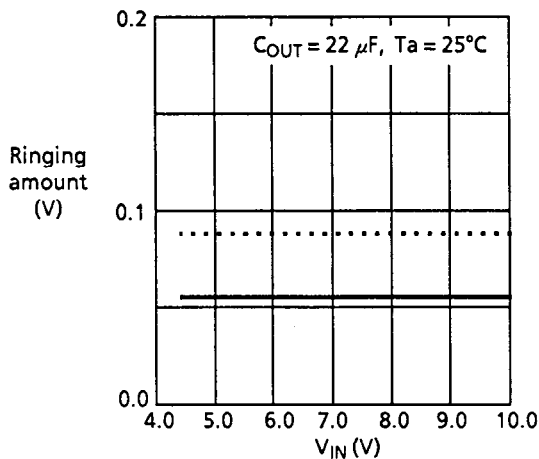

1.2 V_{RO} pin

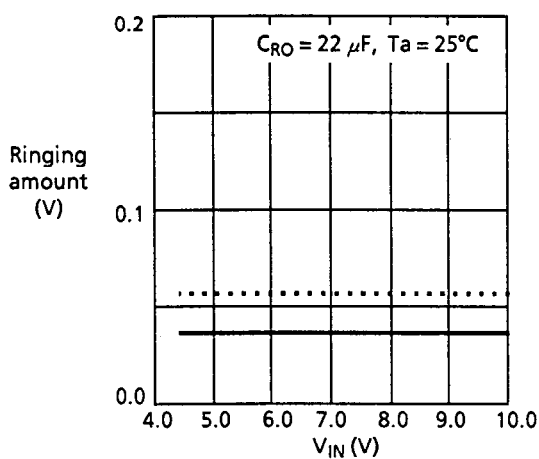

2. C_{OUT} dependency

2.1 V_{OUT} pin

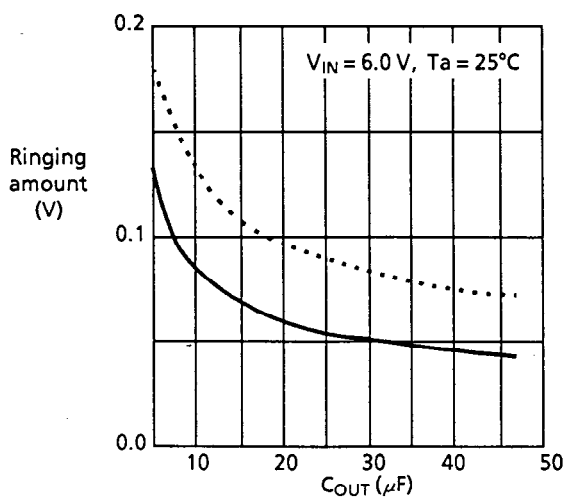

2.2 V_{RO} pin

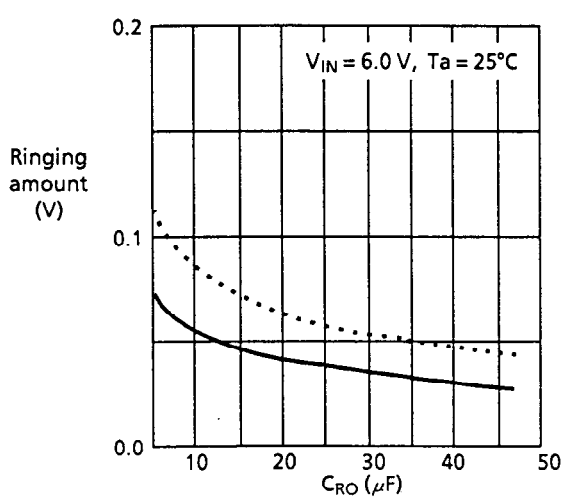

— Overshoot
 Undershoot

3. ΔI_{OUT} Dependency

ΔI_{OUT} or ΔI_{RO} shows the fluctuation between the low current stabilized at 10 μA and the high current. For example, $\Delta I_{OUT} = 10$ mA means the fluctuation between 10 μA and 10 mA.

3.1 V_{OUT} pin

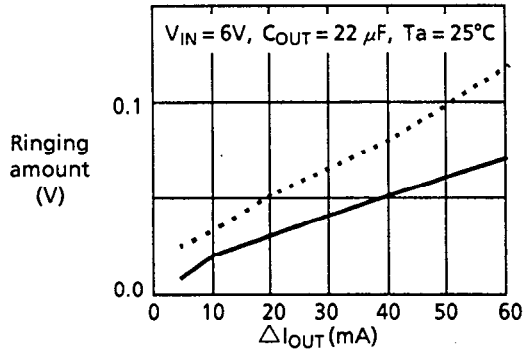

3.2 V_{RO} pin

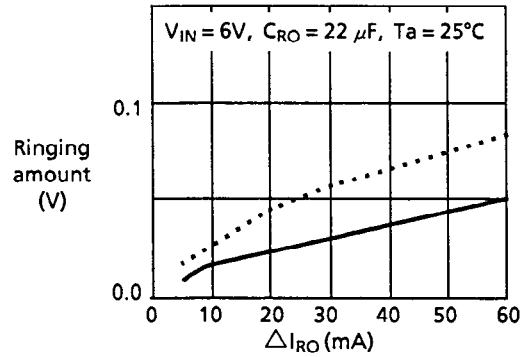

4. Temperature dependency

4.1 V_{OUT} pin

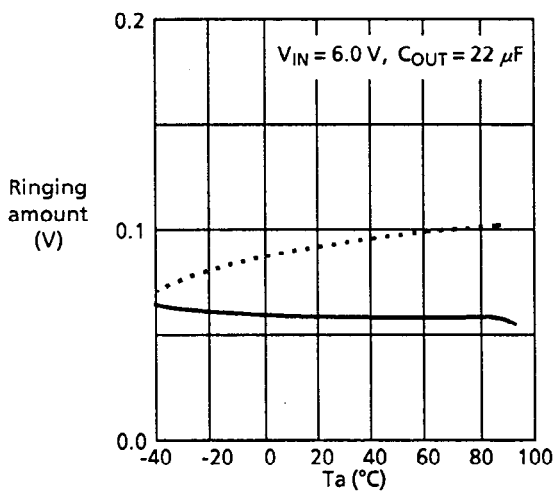

4.2 V_{RO} pin

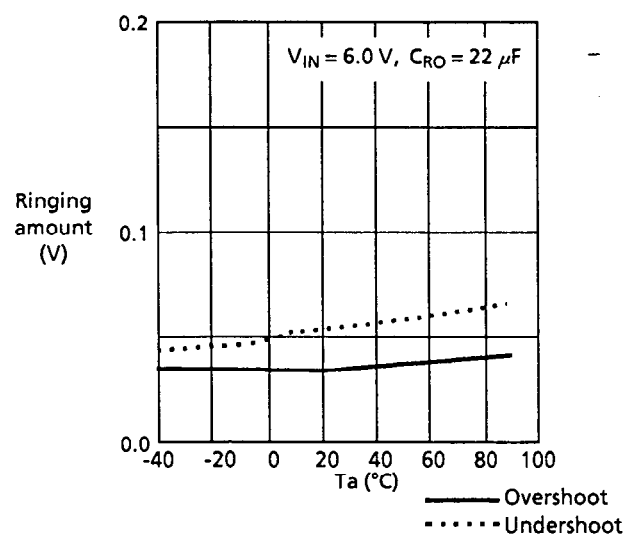

3. Selecting Load Capacitance

The results in 1 and 2 show that the parameter dependency due to the input voltage fluctuation of type II is the opposite of type I, and the output current fluctuation (the amount of ringing is small). Comparing types I and II with respect to the input voltage fluctuation allows the proper load capacitance to be determined.

For example, Figure 18 shows the C_{OUT} dependency of types I and II at V_{OUT} pin, respectively. This shows that the proper load capacitance C_{OUT} is $22 \mu F$ or more.

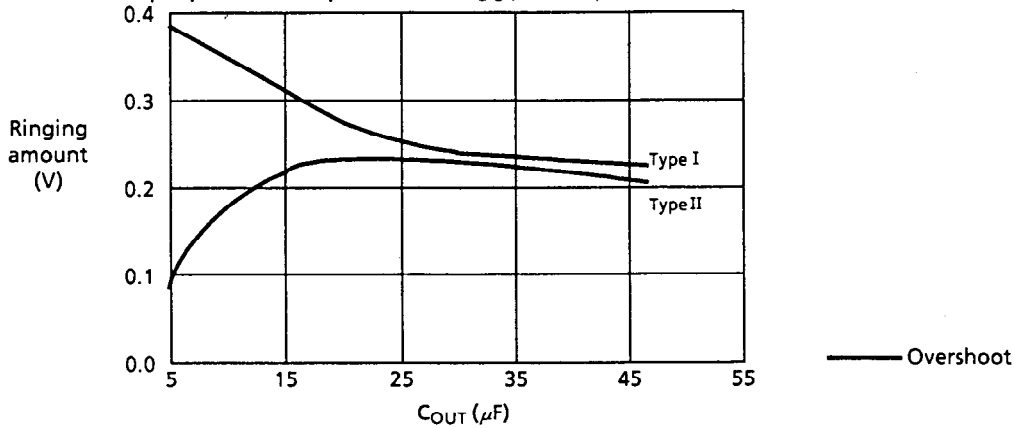

Figure 18

When IC chips or capacitors connected to the V_{RO} and V_{OUT} pins have sufficient room for overshoot and little room for undershoot (V_{OUT} output voltage is close to the detection voltage of the \overline{RESET} voltage detector), use of a capacitor of $22 \mu F$ or more is recommended. In both cases, check the temperature characteristics.

Standard Circuit

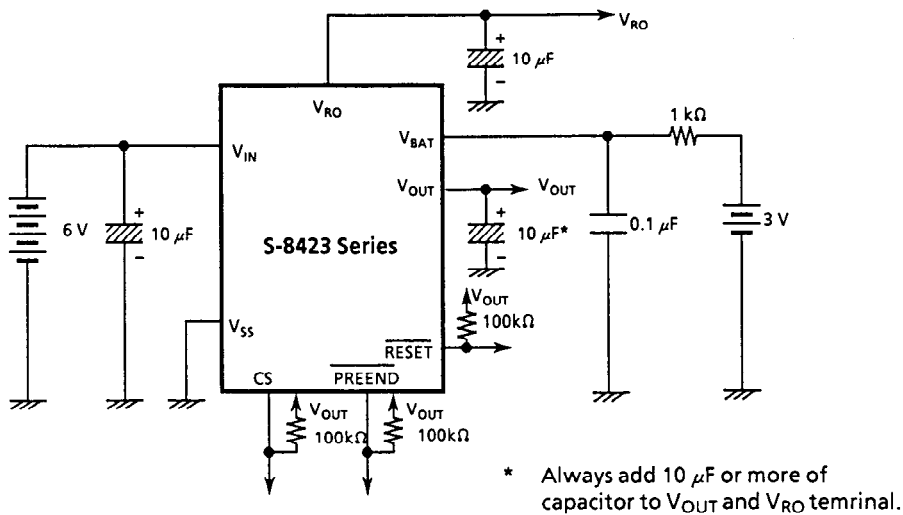

Figure 19

■ Application Circuits

1. Merits in designing

- (1) A switching circuit for primary and backup power supplies is usually configured with discrete components. The S-8423 Series enables you to configure the circuit with a single chip. Some microcomputers can enter standby mode (or low clock mode) from normal mode (or high clock mode) only, and need about 3 V each time they are used. If a low voltage (such as the backup voltage) is applied to these microcomputers initially, they may run away and vast current consumption may flow. The S-8423 Series is designed to have a *special sequence* that stops the backup voltage until the primary power supply voltage reaches the initial voltage that trips the switch.
- (2) Systems can be structured easily. Three types of built-in voltage detectors ($\overline{\text{CS}}$, $\overline{\text{PREEND}}$, and $\overline{\text{RESET}}$) send three types of voltage detection signal to microcomputers.
- (3) Battery service life are prolonged.
 - The I/O voltage difference of the voltage regulator 2 switch is very small, and allows the primary power supply to be used until just before they are completely discharged.
 - The current consumption during backup operation is very small (2.1 μA max.), and allows the backup power supply to have a long service life.

2. Design considerations

- In applications with small I_{RO} or I_{OUT} , output voltages (V_{RO} and V_{OUT}) may rise to cause the load stability to violate standards. Set I_{RO} and I_{OUT} to 10 μA or more.
- Attach the proper capacitor to the V_{OUT} pin to prevent the $\overline{\text{RESET}}$ voltage detector (which monitors the V_{OUT} pin) from being active due to undershoot.
- Watch for overshoot and ensure it does not exceed the ratings of the IC chips and/or capacitors attached to the V_{RO} and V_{OUT} pins.
- Power dissipation of SSOP8 package is shown as Figure 20.
- To prevent improper oscillation of the IC, attach a capacitor of 0.01 μF or more to the V_{RO} pin.
- When the V_{IN} starts to rise from voltage that is more than V_{SW1} , a low pulse of less than 4 ms flows through the $\overline{\text{PREEND}}$ pin even when V_{BAT} is more than the $\overline{\text{PREEND}}$ release voltage. Thus when monitoring the $\overline{\text{PREEND}}$ pin, always make sure it is more than 4 ms after the rising of V_{IN} .
- When V_{IN} falls to 0 V, design peripheral circuits so that V_{IN} falls at the falling edge of 10 ms or more ($C_{\text{OUT}} = 10\mu\text{F}$, $C_{\text{RO}} = 10\mu\text{F}$). In the case of a falling edge of 10 ms or less, the $\overline{\text{RESET}}$ pin goes "L."

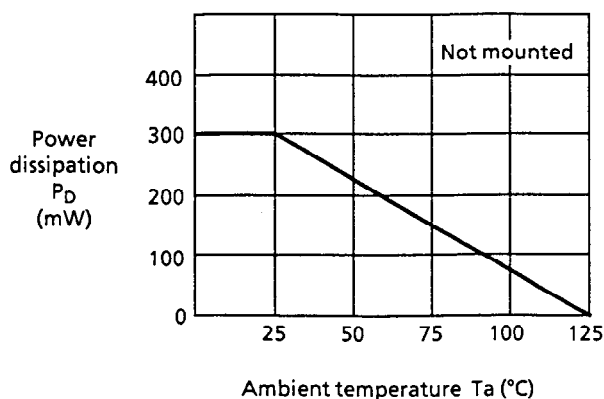

Figure 20 Power dissipation

BATTERY BACKUP IC S-8423 Series

3. Application examples

(1) When using a timer microcomputer for backup and displaying $\overline{\text{PREEND}}$ on the main CPU

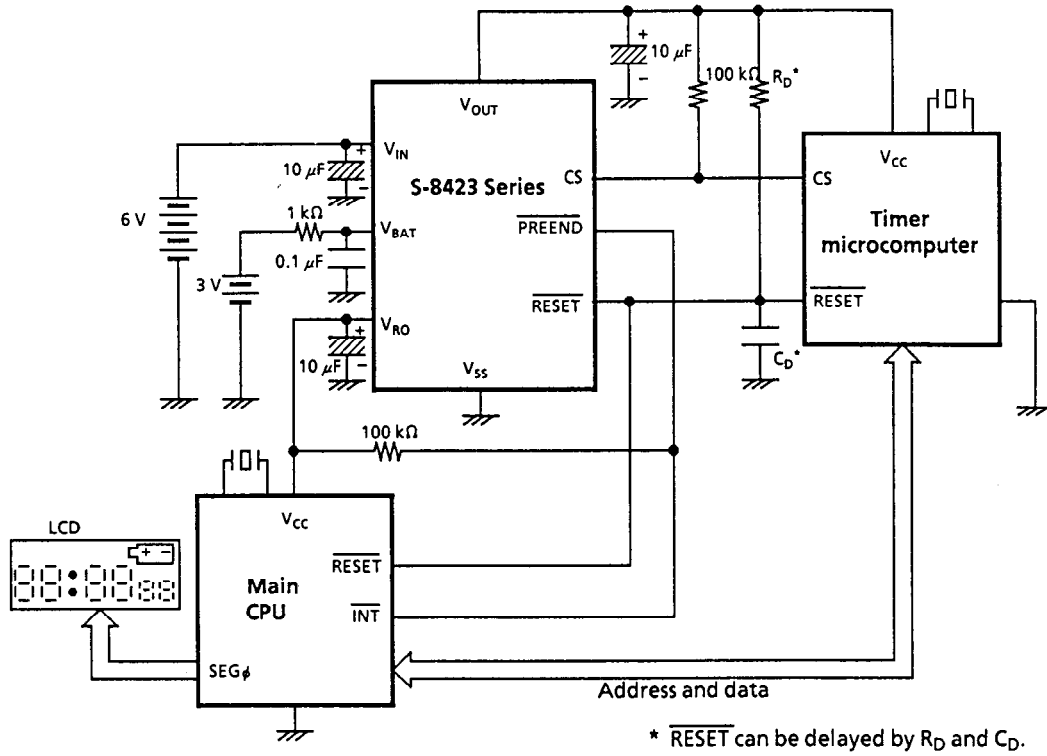
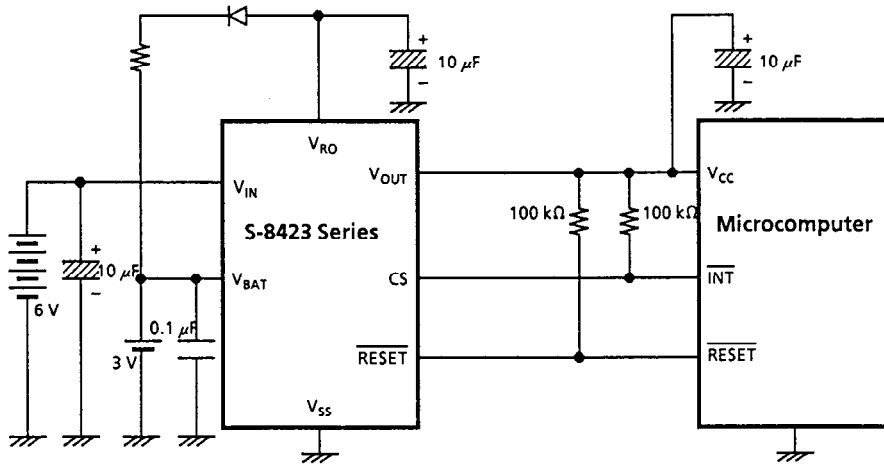

Figure 21

(2) When using rechargeable battery as a backup battery



Backup battery can be floating-recharged by using voltage regulator1

Figure 22

(3) Memory card

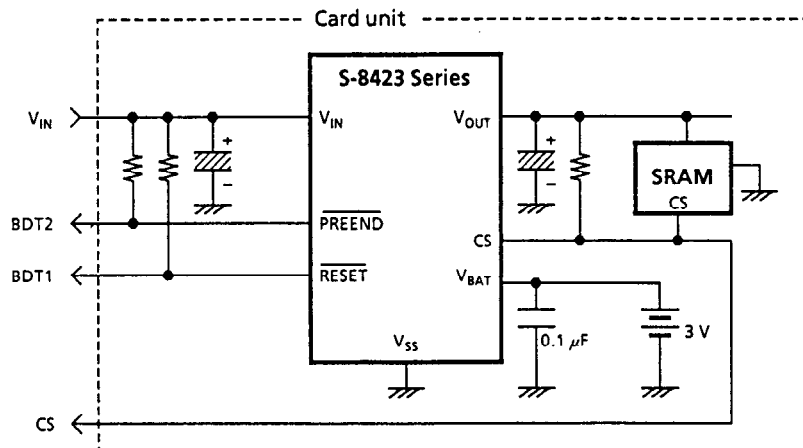

Figure 23

■ Dimensions

8-pin SSOP

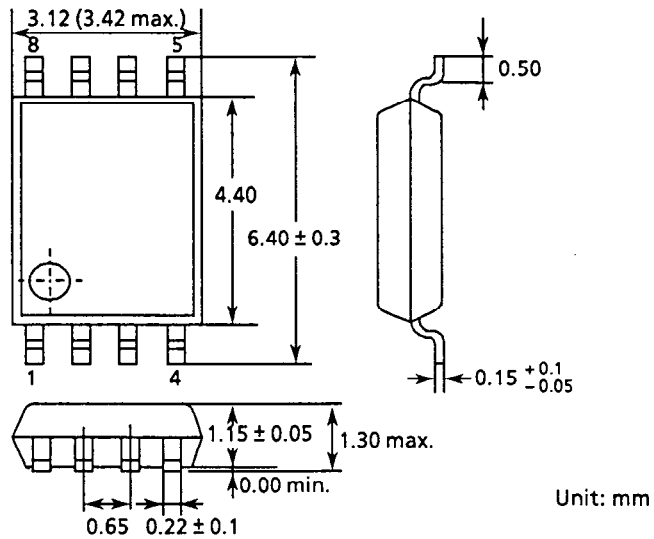
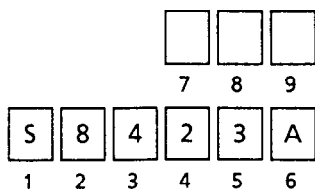

Figure 24

■ Markings



- 1 to 6 : Product name
- 7 : Assembly code
- 8 : Year of assembly (last digit)
- 9 : Month of assembly; Jan. = 1, Feb. = 2, Mar. = 3, Apr. = 4, May = 5, June = 6, July = 7, Aug. = 8, Sept. = 9, Oct. = X, Nov. = Y, Dec. = Z

Figure 25

**BATTERY BACKUP IC
S-8423 Series**

■ Taping

1. Tape specifications

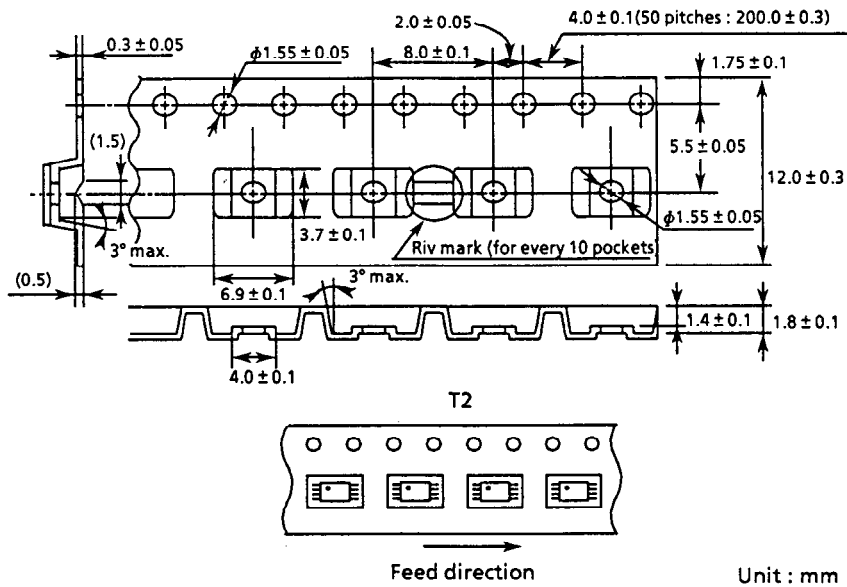

Figure 26

2. Reel specifications

1 reel holds 2000 ICs.

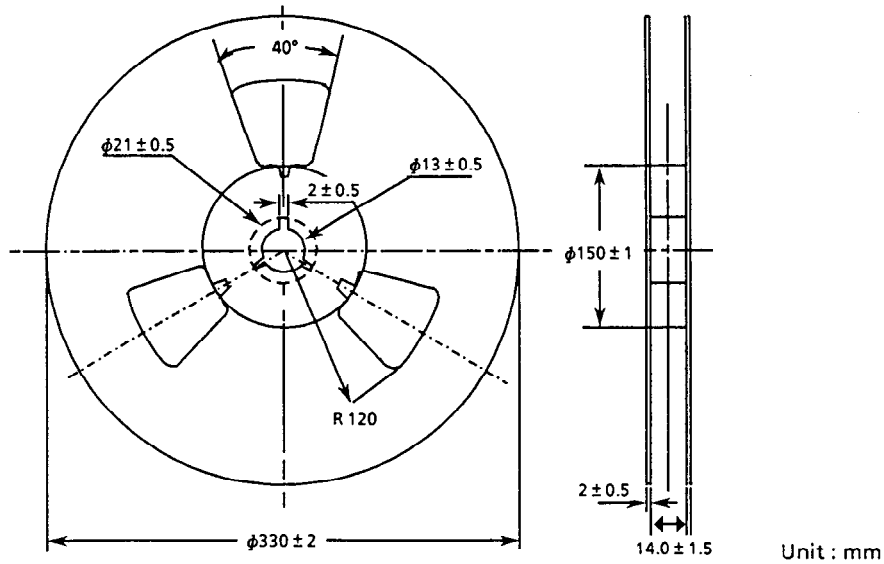

Figure 27

■ Characteristics

1. Voltage regulator (S-8423AFS)

1.1 Input voltage (V_{IN}) – Output voltage (V_{RO}) (REG1)

(1) $T_a = 85^\circ\text{C}$

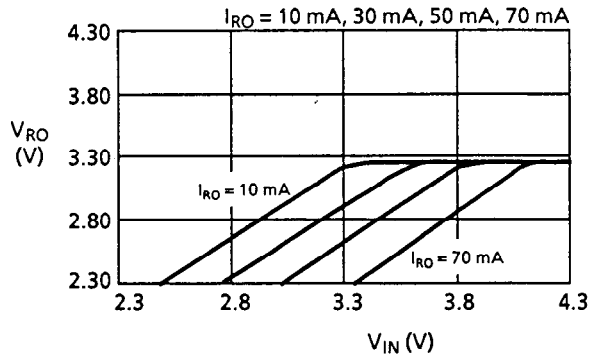

(2) $T_a = 25^\circ\text{C}$

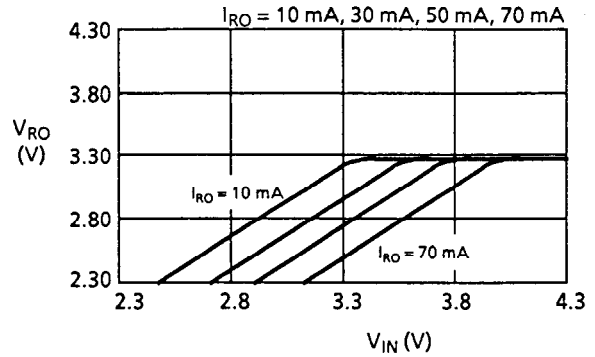

(3) $T_a = -40^\circ\text{C}$

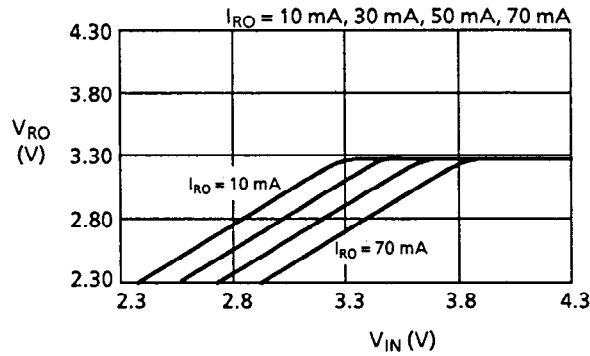

1.2 Input voltage (V_{IN}) – Output voltage (V_{OUT}) (REG2)

(1) $T_a = 85^\circ\text{C}$

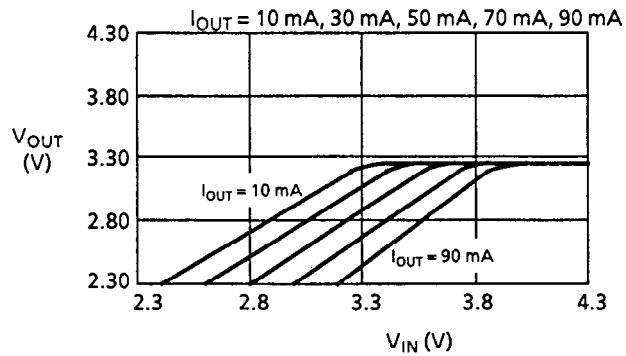

(2) $T_a = 25^\circ\text{C}$

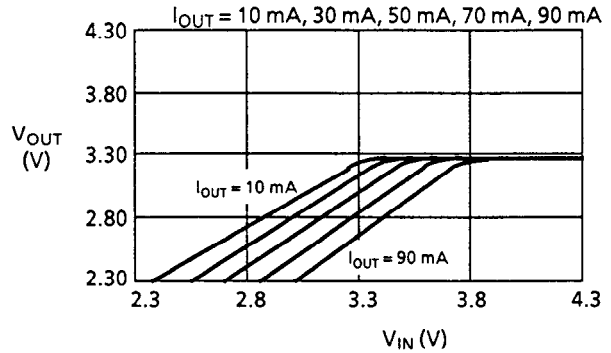

(3) $T_a = -40^\circ\text{C}$

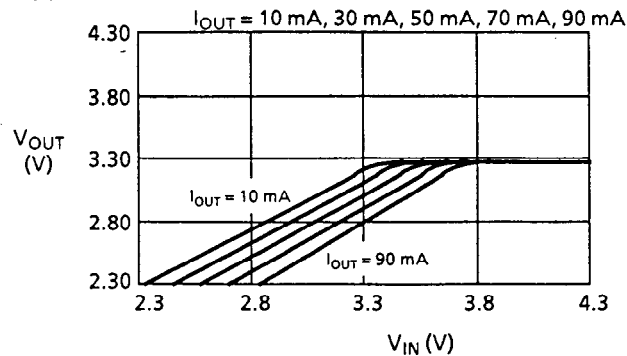

BATTERY BACKUP IC
S-8423 Series

1.3 I/O voltage difference (V_{dif1}) - Output voltage (REG1)

(1) $T_a = 85^\circ\text{C}$

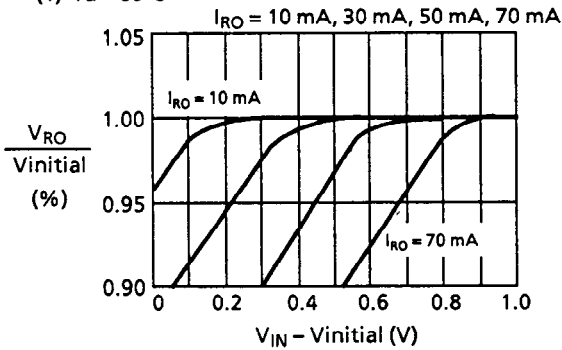

(2) $T_a = 25^\circ\text{C}$

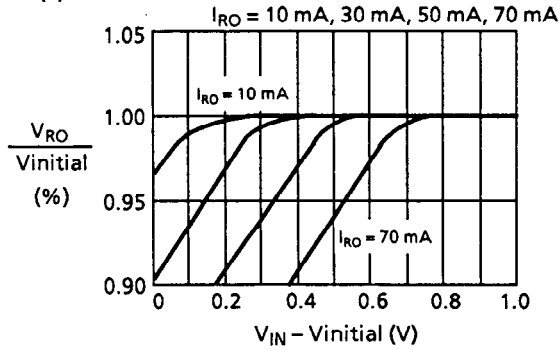

(3) $T_a = -40^\circ\text{C}$

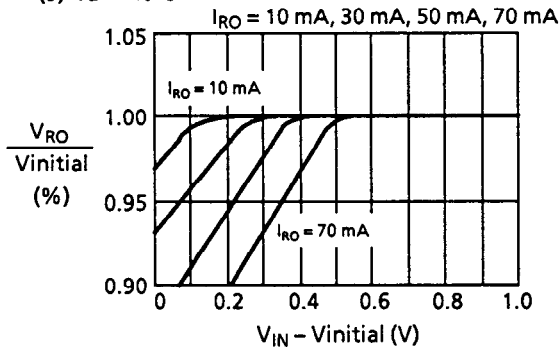

Vinitial : V_{RO} value when input voltage is 6 V.

1.4 I/O voltage difference (V_{dif2}) - Output voltage (REG2)

(1) $T_a = 85^\circ\text{C}$

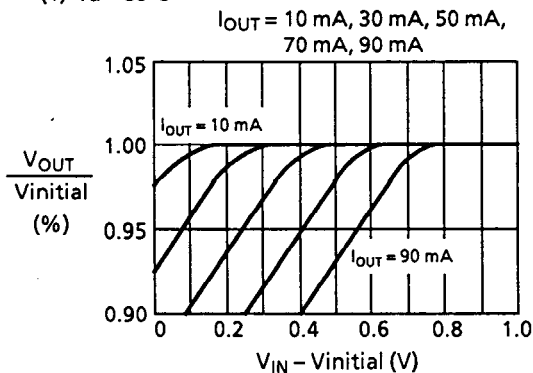

(2) $T_a = 25^\circ\text{C}$

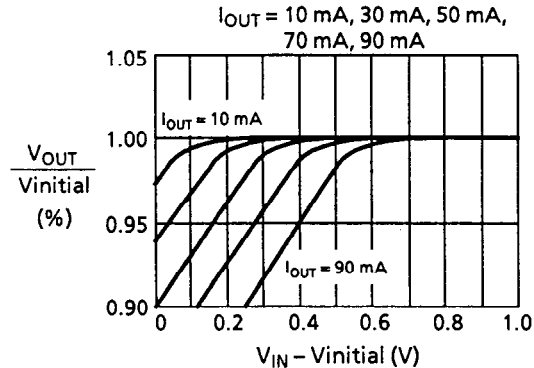

(3) $T_a = -40^\circ\text{C}$

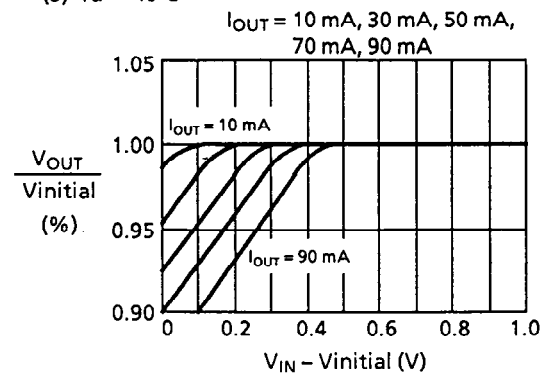

Vinitial : V_{OUT} value when input voltage is 6 V.

1.5 Output current (I_{RO}) - Output voltage (V_{RO})

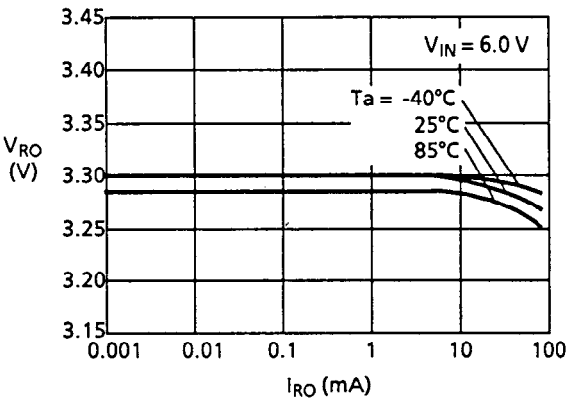

1.6 Output current (I_{OUT}) - Output voltage (V_{OUT})

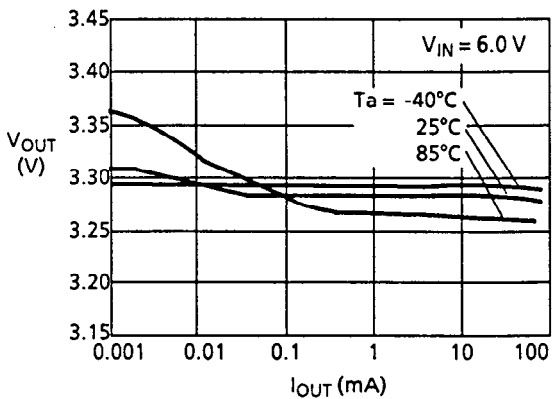

1.7 Output voltage (V_{RO}) - Temperature

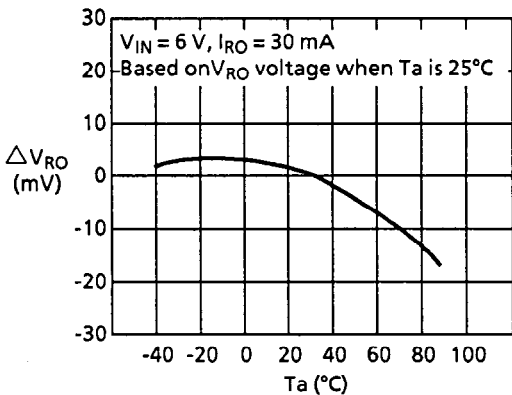

1.8 Output voltage (V_{OUT}) - Temperature

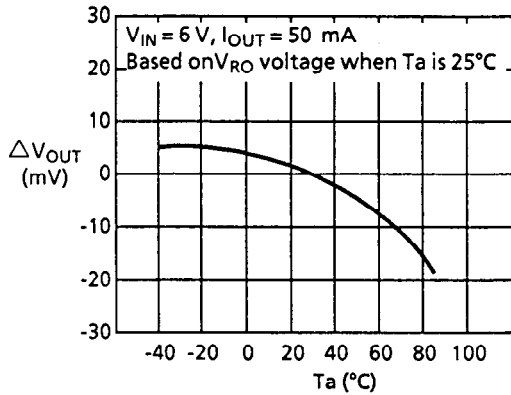

1.9 I/O voltage difference (V_{dif1}) - Temperature

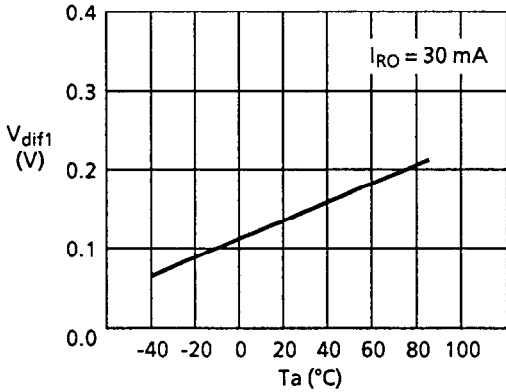

1.10 I/O voltage difference (V_{dif2}) - Temperature

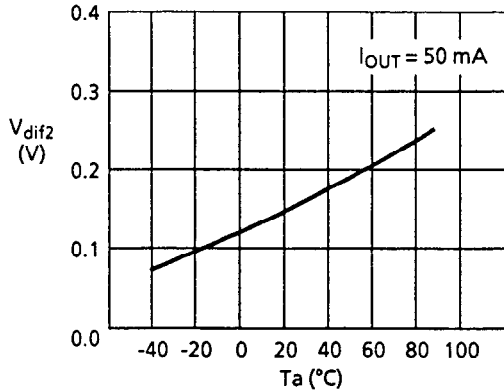

1.11 Input stability (V_{RO}) - Temperature

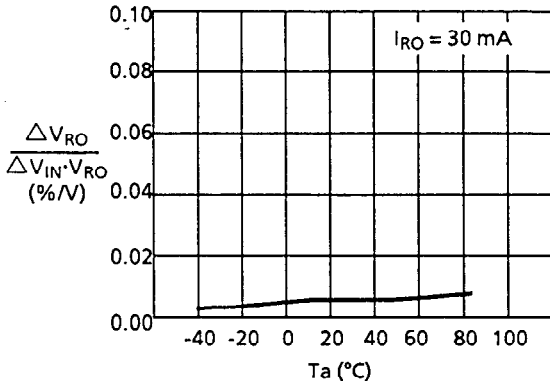

1.12 Input stability (V_{OUT}) - Temperature

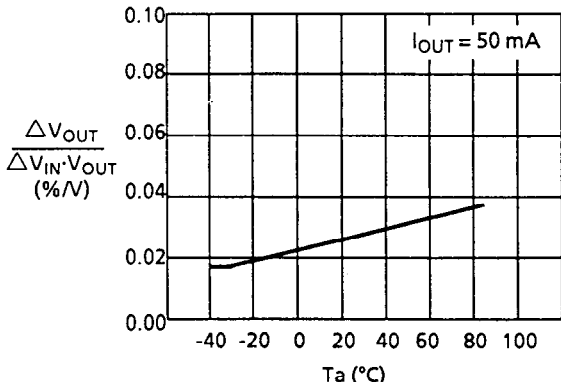

1.13 Load stability (V_{RO}) - Temperature

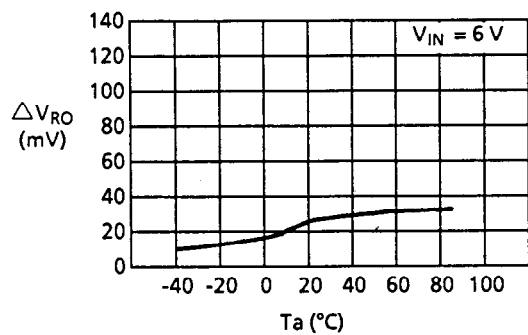

1.14 Load stability (V_{OUT}) - Temperature

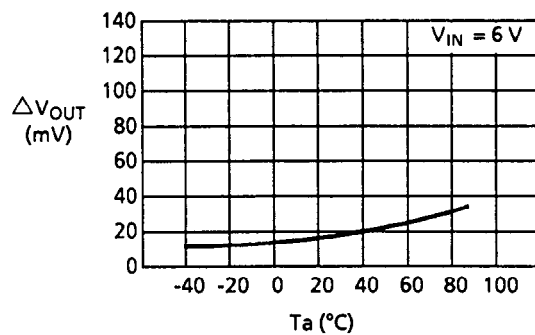

- 2. Voltage regulator (S-8423LFS)

2.1 Input voltage (V_{IN}) - Output voltage (V_{RO}) (REG1)

(1) $T_a = 85^\circ\text{C}$

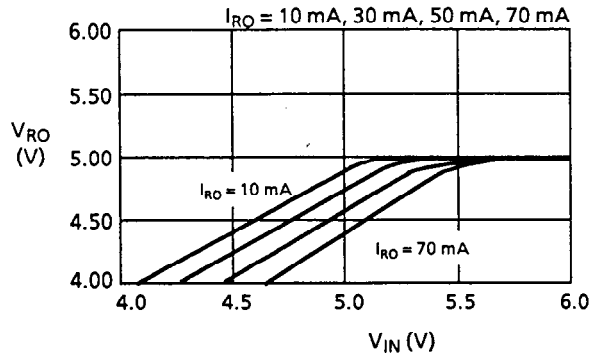

(2) $T_a = 25^\circ\text{C}$

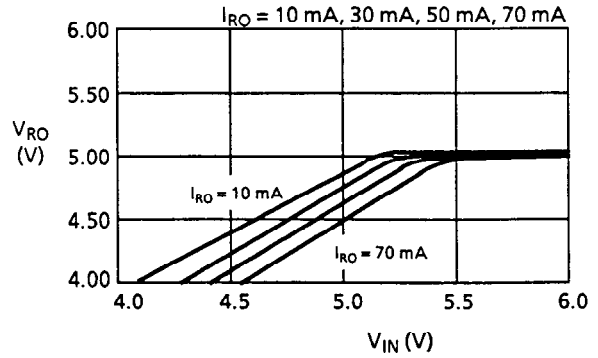

(3) $T_a = -40^\circ\text{C}$

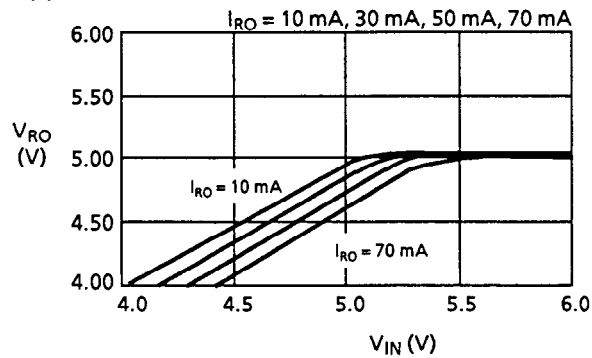

2.2 Input voltage (V_{IN}) - Output voltage (V_{OUT}) (REG2)

(1) $T_a = 85^\circ\text{C}$

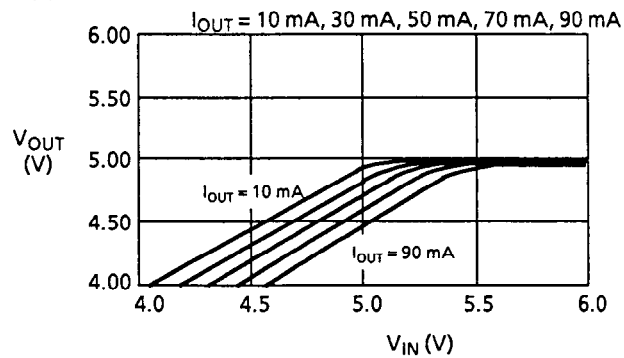

(2) $T_a = 25^\circ\text{C}$

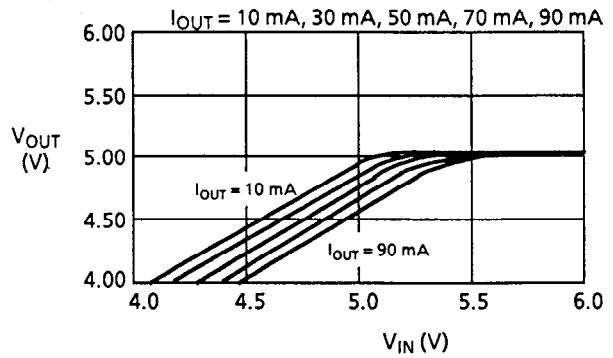

(3) $T_a = -40^\circ\text{C}$

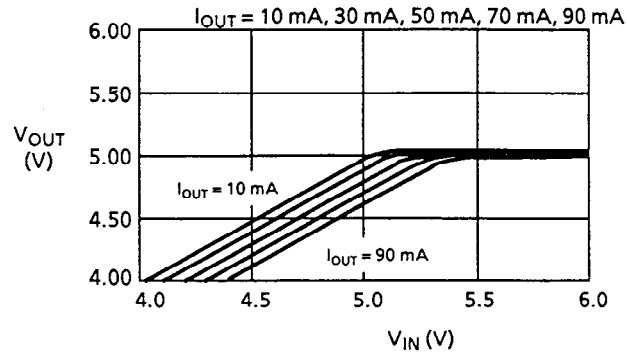

2.3 I/O voltage difference (V_{dif1}) - Output voltage (REG1)

(1) $T_a = 85^\circ\text{C}$

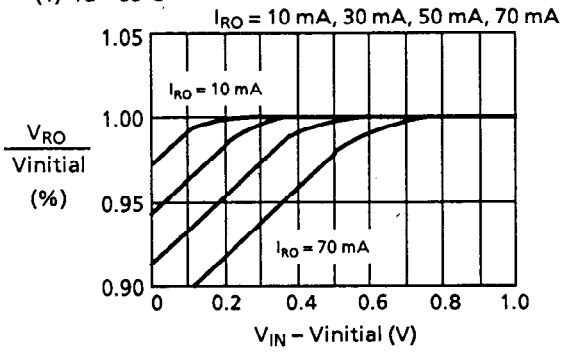

(2) $T_a = 25^\circ\text{C}$

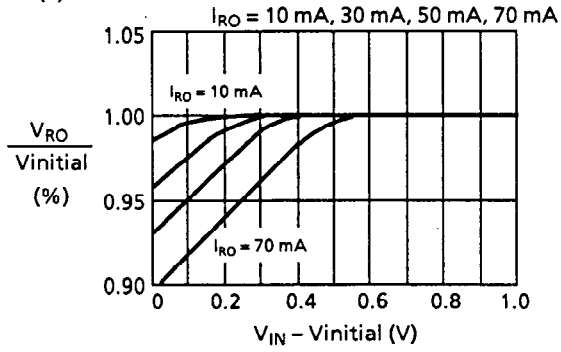

(3) $T_a = -40^\circ\text{C}$

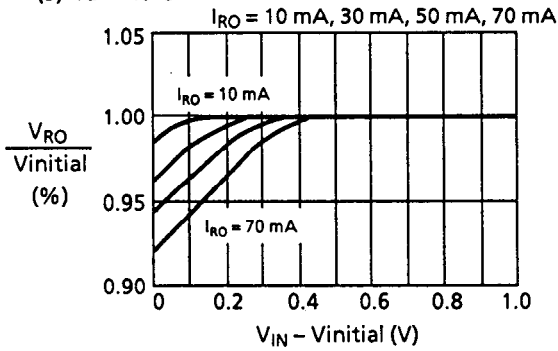

Vinitial : V_{RO} value when input voltage is 6 V.

2.4 I/O voltage difference (V_{dif2}) - Output voltage (REG2)

(1) $T_a = 85^\circ\text{C}$

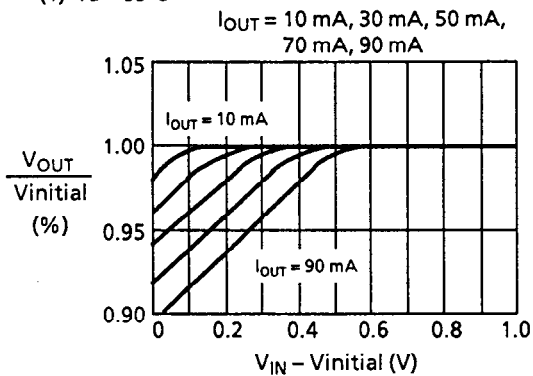

(2) $T_a = 25^\circ\text{C}$

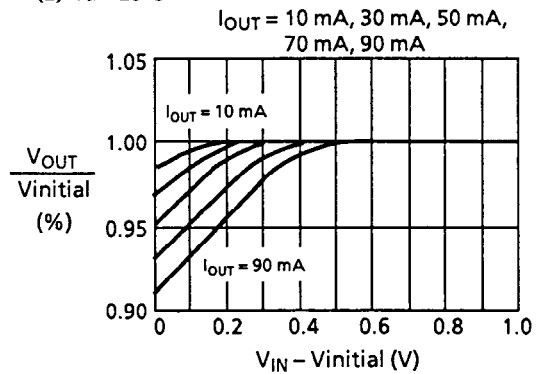

(3) $T_a = -40^\circ\text{C}$

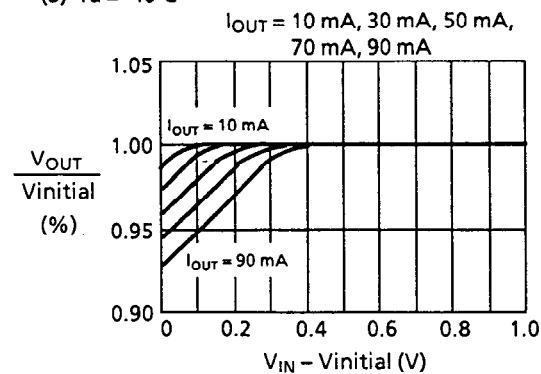

Vinitial : V_{OUT} value when input voltage is 6 V.

2.5 Output current (I_{RO}) - Output voltage (V_{RO})

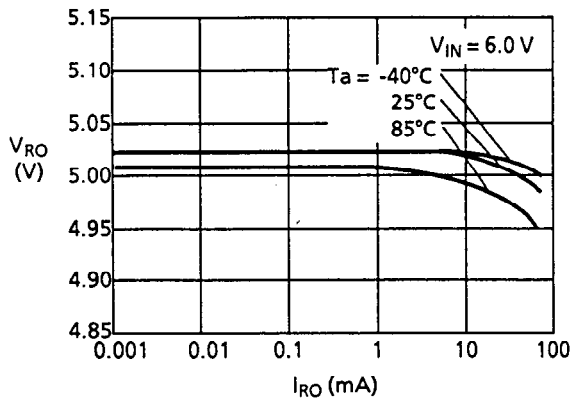

2.6 Output current (I_{OUT}) - Output voltage (V_{OUT})

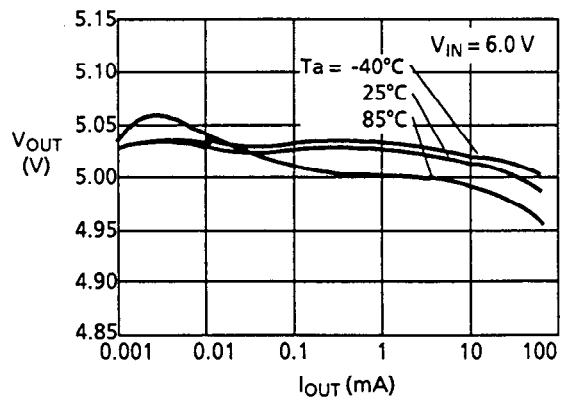

2.7 Output voltage (V_{RO}) - Temperature

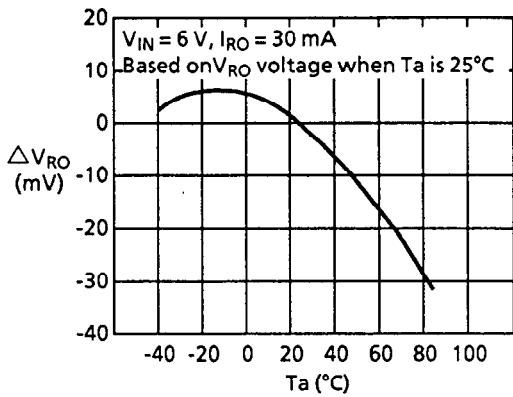

2.8 Output voltage (V_{OUT}) - Temperature

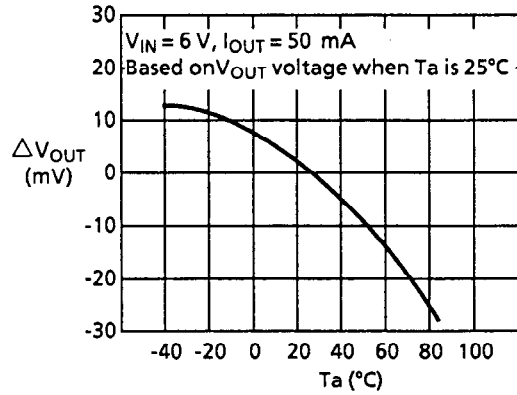

2.9 I/O voltage difference (V_{dif1}) - Temperature

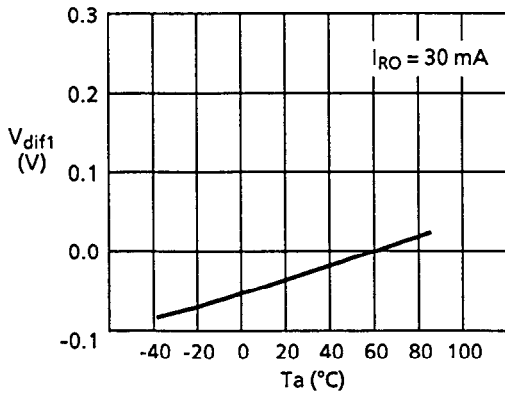

2.10 I/O voltage difference (V_{dif2}) - Temperature

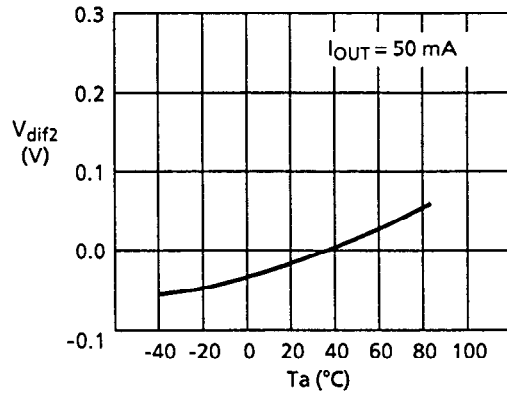

2.11 Input stability (V_{RO}) - Temperature

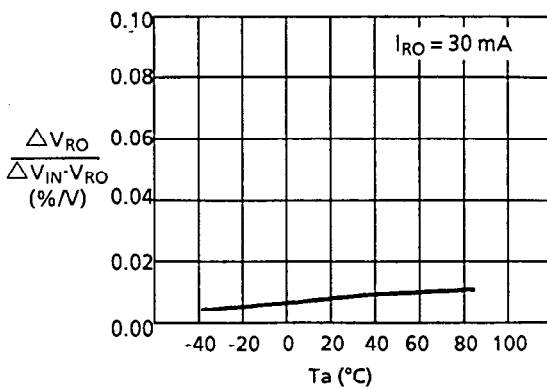

2.12 Input stability (V_{OUT}) - Temperature

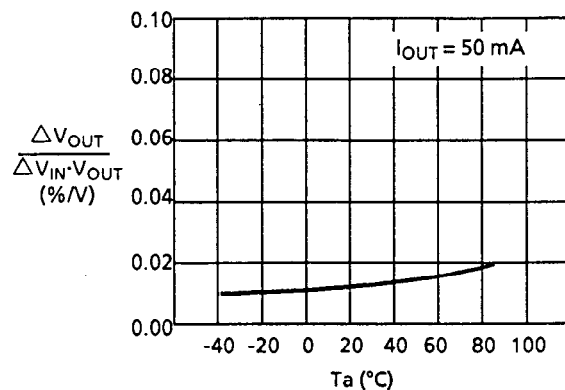

2.13 Load stability (V_{RO}) - Temperature

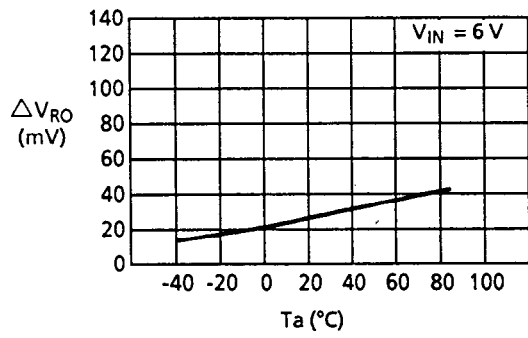

2.14 Load stability (V_{OUT}) - Temperature

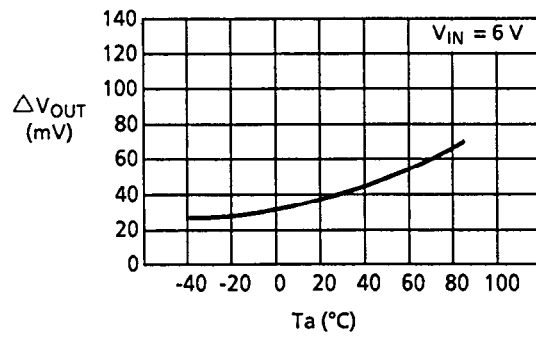

- 3. Switch

3.1 Switch voltage (V_{SW1}) – Temperature

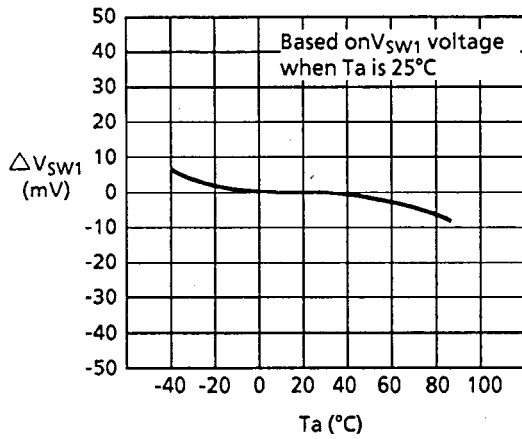

3.2 CS output prohibition voltage (V_{SW2}) – Temperature

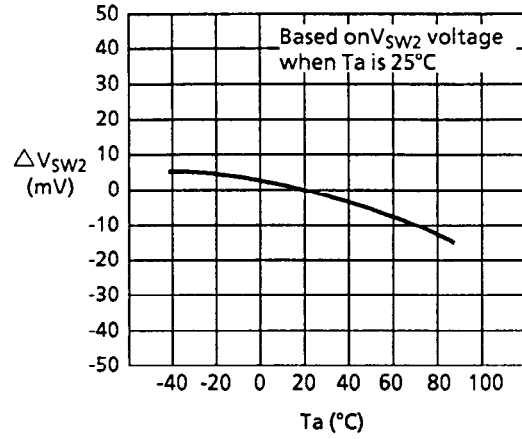

3.3 Input voltage (V_{BAT}) – V_{BAT} switch resistance

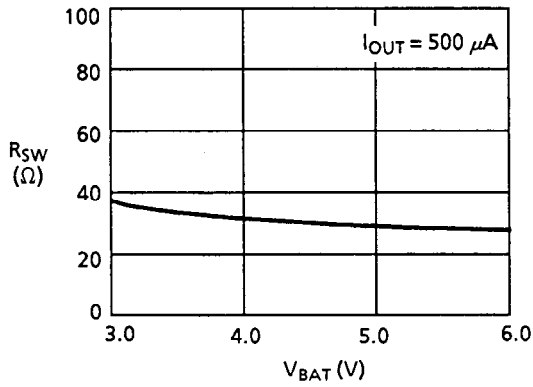

3.4 V_{BAT} switch resistance – Temperature

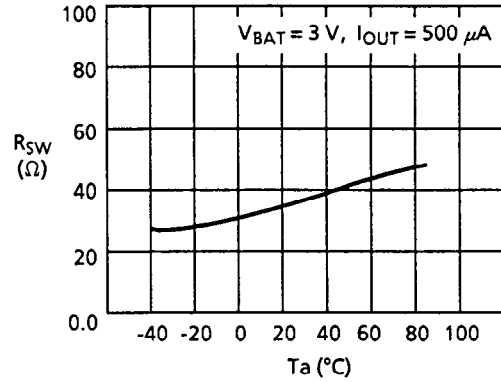

3.5 V_{BAT} switch leak current (I_{LEK}) – Temperature

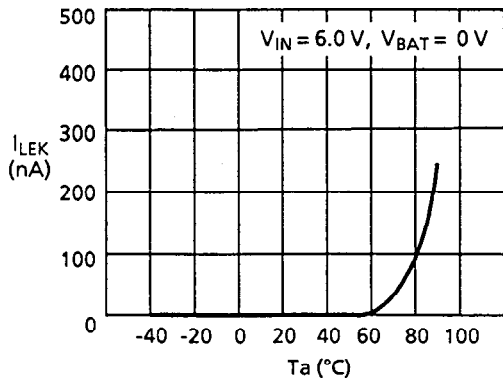

4. Voltage detectors

4.1 CS voltage detector

(1) Detection voltage ($-V_{DET1}$) - Temperature

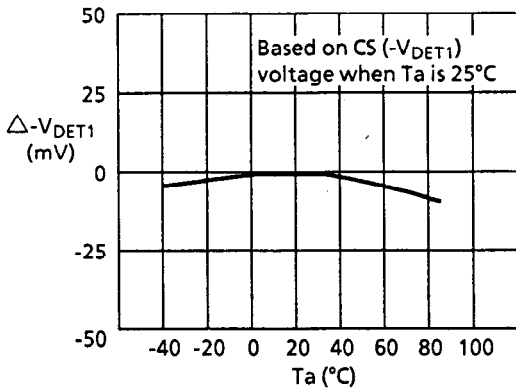

(2) Output current (I_{SINK})

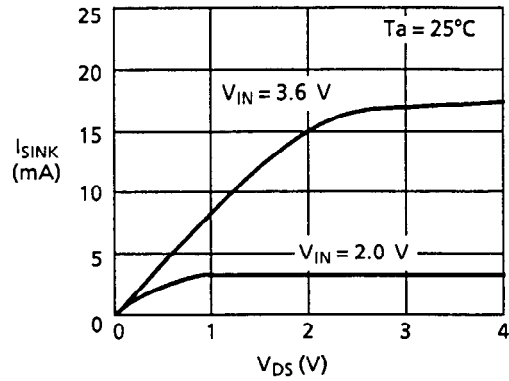

(3) Output current (I_{SINK}) - Temperature

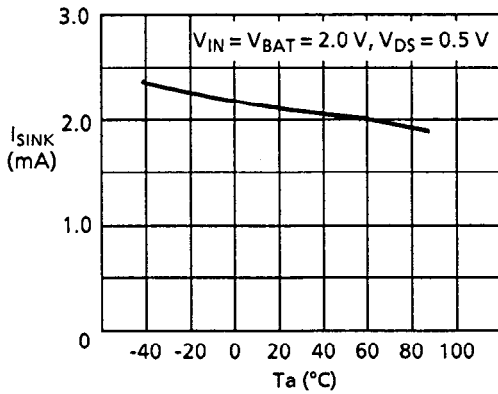

4.2 RESET voltage detector

(1) Detection voltage ($-V_{DET2}$) - Temperature

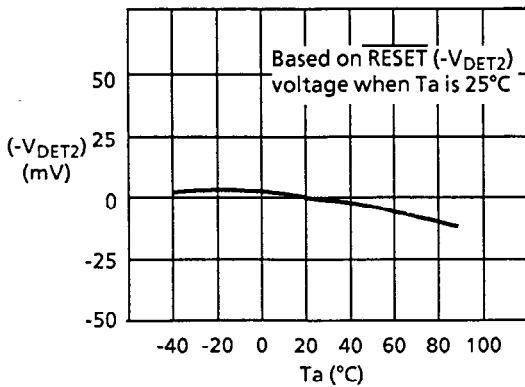

(2) Output current (I_{SINK})

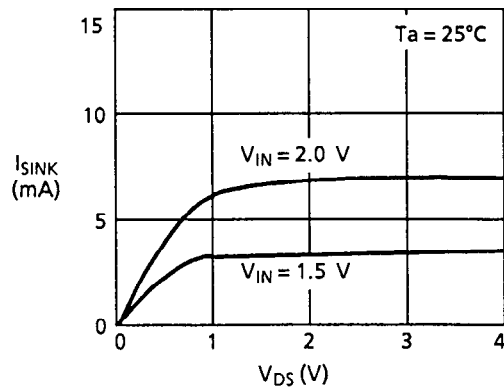

(3) Output current (I_{SINK}) - Temperature

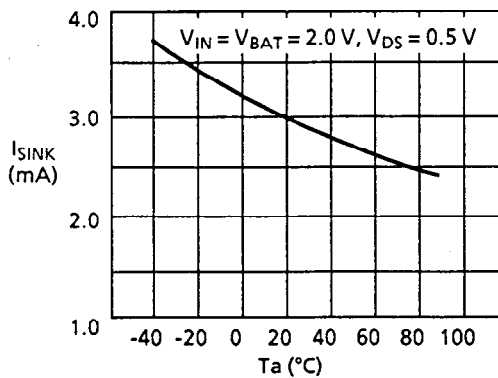

4.3 $\overline{\text{PREEND}}$ voltage detector

(1) Detection voltage ($-V_{\text{DET3}}$) - Temperature

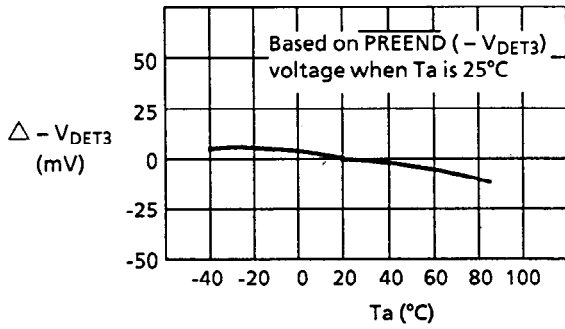

(2) Output current (I_{SINK})

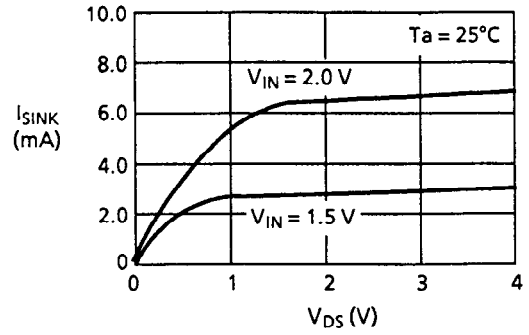

(3) Output current (I_{SINK}) - Temperature

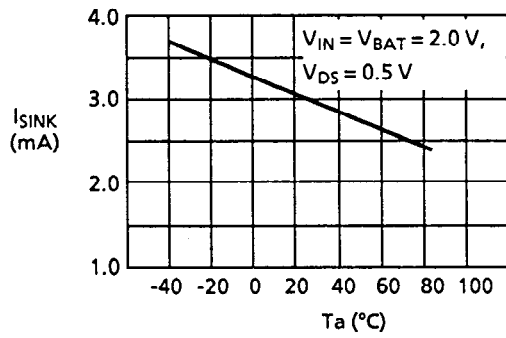

5. Current consumption

5.1 $V_{IN} - V_{IN}$ current consumption (I_{SS1})

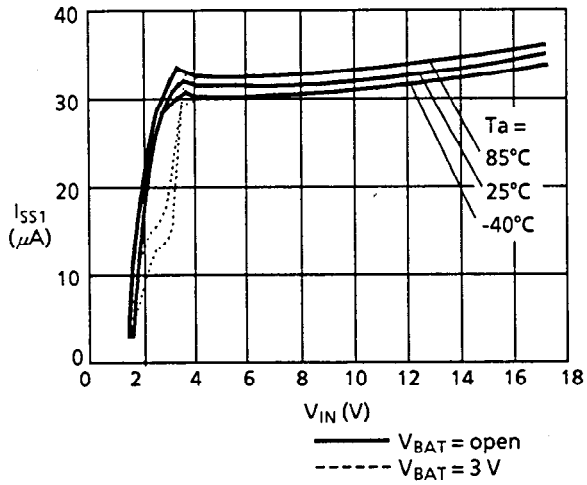

5.2 $V_{BAT} - V_{BAT2}$ current consumption (I_{BAT2})

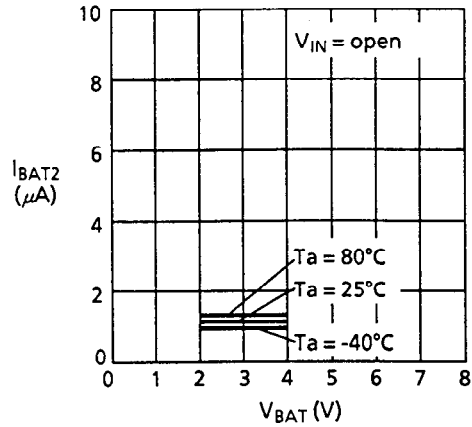

5.3 Temperature

(1) I_{SS1}

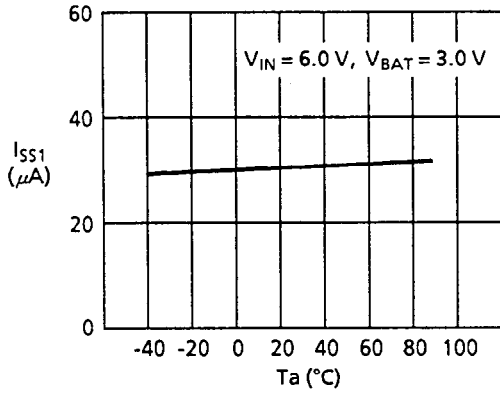

(2) I_{BAT1}

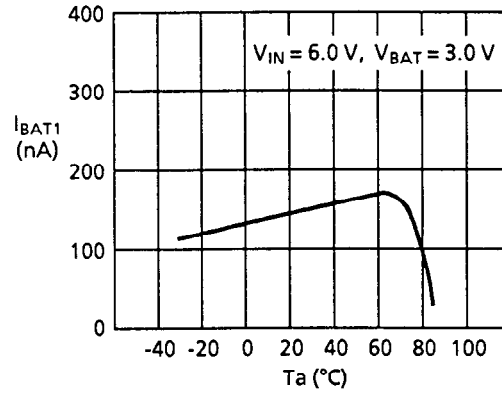

(3) I_{BAT2}

