

Combination of excellent solder strength & size merit
(3.5×3.55mm with height of 1.25mm)

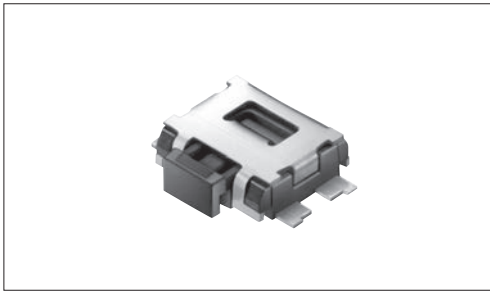

■ Typical Specifications



Items	Specifications
Rating (max.)	50mA 12V DC
Rating (min.)	10μA 1V DC
Initial contact resistance	100mΩ max.
Travel (mm)	0.2

■ Product Line

Side push type

Product No.	Operating force	Operating direction	Operating life (5mA 5V DC)	Guide bosses	Minimum order unit (pcs.)	
					Japan	Export
SKSCLCE010	1.6N	Side push	100,000 cycles	Without	5,000	5,000
SKSCLAE010	2.2N					
SKSCLDE010	1.6N			With		
SKSCLBE010	2.2N					

With ground terminal type

Product No.	Operating force	Operating direction	Operating life (5mA 5V DC)	Guide bosses	Minimum order unit (pcs.)	
					Japan	Export
SKSCPCE010	1.6N	Side push	100,000 cycles	Without	5,000	5,000
SKSCP AE010	2.2N					
SKSCPDE010	1.6N			With		
SKSCPBE010	2.2N					

■ Packing Specifications

Taping

Number of packages (pcs.)			Tape width (mm)	Export package measurements (mm)
1 reel	1 case / Japan	1 case / export packing		
5,000	50,000	50,000	12	401×401×214

Note

For reels of 330mm diameter, please inquire.

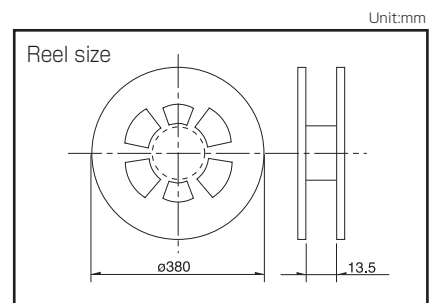

Refer to P.259 for soldering conditions.





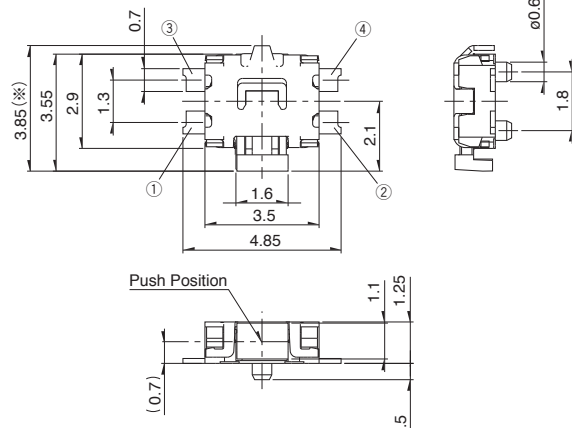
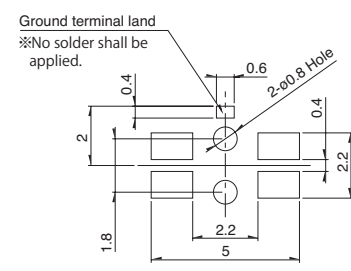



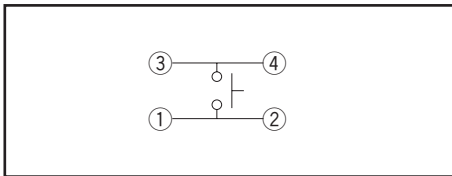

















■ Dimensions

Unit:mm

Style	PC board mounting hole and land dimensions (Viewed from switch mounting face)
	 <p>Ground terminal land **No solder shall be applied.</p> <p>Ground terminal land pattern is applicable to ground terminal type only.</p>

■ Circuit Diagram



Type		Sharp Feeling Type								
		Surface Mount								
Series		SKHU	SKTD	SKSN	SKTG	SKSL	SKSC	SKRT	SKRV	SKRH
Photo										
Features		—	Low-profile	Mid-mount	Half-mount		Low-profile	—	4-direction switch + push switch	
Water-proof		○	●	—	●	—	—	—	—	—
Dust-proof		○	●	—	●	—	—	—	—	—
IP standard		—	67 equivalency	—	67 equivalency	—	—	—	—	—
Operating direction	Top push	●	—	—	—	—	—	—	●	●
	Side push	—	●	●	●	●	●	●	●	●
Dimensions (mm)	W	6.2	3.9	6.2	5.2	4.5	3.5	4.5	6.45	7.35
	D	6.3	2.9	3	3.5	2.6	3.55	3.4	6.4	7.5
	H	2.5/3.1	1.55	3.5	1.55	2.2	1.25	3.3	4	5
Operation force coverage	to 1N									See the relevant pages for respective product description
	1N to 2N									
	2N to 3N									
	3N to 4N									
4N to 5N										
Travel (mm)		0.25	0.15	0.2	0.15		0.2		See the relevant pages for respective product description	
Ground terminal		●	●	●	●	●	○	●	●	●
Operating temperature range		−40°C to +85°C	−30°C to +85°C	−40°C to +85°C	−30°C to +85°C			−40°C to +90°C	−20°C to +70°C	−40°C to +85°C
Automotive use		○	—	—	—	—	—	—	—	—
Life Cycle										
Electrical performance	Rating (max.) (Resistive load)	50mA 12V DC								
	Rating (min.) (Resistive load)	10μA 1V DC								
	Insulation resistance	100MΩ min. 100V DC 1min.								
	Voltage proof	250V AC 1min.	100V AC 1min.	250V AC 1min.	100V AC 1min.	250V AC 1min.	100V AC 1min.	250V AC 1min.	100V AC 1min.	
Durability	Vibration	10 to 55 to 10Hz/min., the amplitude is 1.5mm for all the frequencies, in the 3 direction of X, Y and Z for 2 hours respectively								
	Lifetime	Shall be in accordance with individual specifications.								
Environmental performance	Cold	−40°C 96h						−30°C 96h	−40°C 96h	
	Dry heat	90°C 96h	85°C 96h	90°C 96h	85°C 96h	90°C 96h		80°C 96h	90°C 96h	
	Damp heat	60°C, 90 to 95%RH 96h								
Page		237	239	240	241	242	243	245	453	454

W : Width. The most outer dimension excluding terminal portion.
D : Depth. The most outer dimension excluding terminal portion.
H : Height. The minimum dimension if there are variances.

TACT Switch™ Soldering Conditions	259
TACT Switch™ Cautions	260

Notes

- The automotive operating temperature range to be individually discussed upon request.
- Indicates applicability to all products in the series, while ○ indicates applicability to some products in the series.

Condition for Reflow

Available for Surface Mount Type.

1. Temperature measurement: Thermocouple ϕ 0.1 to 0.2 CA (K) or CC (T) at solder joints (copper foil surface).
A heat resistive tape should be used to fix thermocouple.
2. Temperature profile

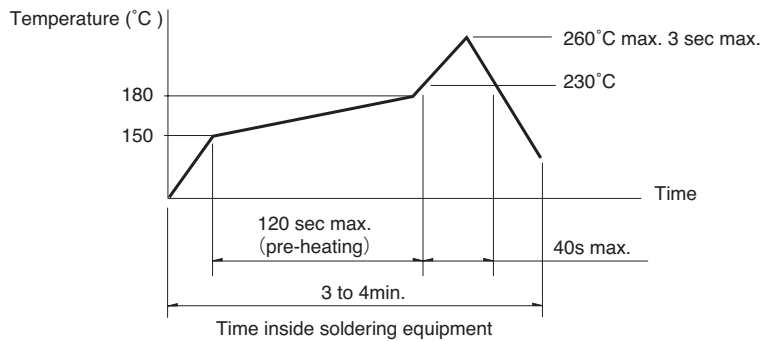

Notes

1. The above temperature shall be measured of the top of switch. There are cases where the PC board's temperature greatly differs from that of the switch, depending on the material, size, thickness of PC boards and others.
The above-stated conditions shall also apply to switch surface temperatures.
2. Soldering conditions differ depending on reflow soldering machines.
Prior verification of soldering condition is highly recommended.

Conditions for Auto-dip

Available for Snap-in Type and Radial Type.

Items	Condition
Flux built-up	Mounting surface should not be exposed to flux
Preheating temperature	Ambient temperature of the soldered surface of PC board. 100°C max.
Preheating time	60s max.
Soldering temperature	260°C max.
Duration of immersion	5s max.
Number of soldering	2times max.

SKHH, SKPD Series

Items	Condition
Flux built-up	Mounting surface should not be exposed to flux
Preheating temperature	Ambient temperature of the soldered surface of PC board. 110°C max.
Preheating time	60s max.
Soldering temperature	260°C max.
Duration of immersion	5s max.
Number of soldering	2times max.

SKQJ, SKQK, SKEG Series

Items	Condition
Flux built-up	Mounting surface should not be exposed to flux
Preheating temperature	Ambient temperature of the soldered surface of PC board. 100°C max.
Preheating time	45s max.
Soldering temperature	255°C max.
Duration of immersion	5s max.
Number of soldering	2times max.

Manual Soldering

Items	Condition
Soldering temperature	350°C max.
Duration of soldering	3s max.
Capacity of soldering iron	60W max.

SKHH, SKHW, SKRG, SKPD Series

Items	Condition
Soldering temperature	360°C max.
Duration of soldering	3s max.
Capacity of soldering iron	60W max.

SKTD, SKTG, SKQJ, SKQK, SKEG Series

Items	Condition
Soldering temperature	350°C max.
Duration of soldering	3s max.
Capacity of soldering iron	20W max.

Notes

1. Prevent flux penetration from the top side of the TACT Switch™.
2. Switch terminals and a PC board should not be coated with flux prior to soldering.
3. The second soldering should be done after the switch is stable with normal temperature.
4. Use the flux with a specific gravity of min 0.81.
(EC-19S-8 by TAMURA Corporation, or equivalents.)