

---

## 8.5GHz Wireless Radar Transceiver Module

---

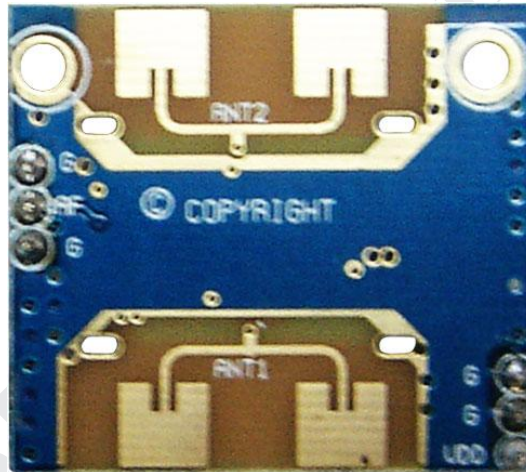

### Version History

Version	Date	Changes
V1.01	Feb.24, 2009	1 <sup>st</sup> . Edition
V1.02	Mar.27, 2009	2 <sup>nd</sup> . Edition

## Key Feature

- Dual 2 patch antenna
- Operating frequency 8.5GHz
- 10dBm output power
- 50m detection distance

## Function Introduction

TRW-10GHz is high frequency radar transceiver module. It is using Doppler Effect Theory to detect frequency change when person or objects move. When it finish signal detect, it will output to MCU to detect or OP AMP voltage comparator to deal with signal strength.

Performance of this module is different from PIR (Passive infrared sensor), PIR distance will be very short because of temperature changes.

More stable, long distance, wide angle, high sensitivity, cost is lower than PIR and easy for using.

It can use in various products. Whatever indoor or outdoor, you can design different products to fit difference place and environment.

Using this module, you don't need to waste energy, save electricity fees and extended product life to let energy-saving and minus carbon purpose coming true.

It can widely use in automatic door opener, security system, automatic light sensor, traffic speed searching, traffic light signal control, office power management, intelligent control, medical probe and so on.

## Doppler Effect

The Doppler Effect is something which occurs likes sound or light moves relative to an observer. The object, observer, or both can move, causing an apparent change in the frequency of the wavelengths being emitted by the object.

The Doppler Effect explains why a rude driver's car horn appears to change in frequency as he or she zooms by while leaning on it, and an understanding of the Doppler Effect can help scientists make a variety of observations about the world around them.

When an object approaches an observer, the wavelengths are compressed, causing the frequency to increase, and as the object moves away, the wavelengths spread out, causing a corresponding decrease in frequency.

When an object is approaching an observer, the frequency of the wavelengths appears to increase, in a phenomenon known as blue shifting. As the object moves away from the observer, the frequency seems to decrease from the observer's perspective, in a situation known as red shifting. Another example commonly used to illustrate the Doppler Effect is the siren of an emergency

vehicle. As the vehicle approaches, the pitch of the siren seems to change, causing it to sound.

### Application

- Automatic door opener
- Security system
- Automatic light sensor
- Staircase & aisle light
- Turf sensor light
- Parking light control
- Traffic light signal control
- Office power management
- Traffic speed searching
- Intelligent control
- Medical probe

### Electrical Specification

Parameter	Specification			Unit	Condition
	Min	Type	Max		
Frequency Range	8.2		8.7	GHz	
Output Power	8		12	dBm	
IF output Amplitude			400	mV	VPP
Supply Voltage, VDD		5		V	DC
Current		45		mA	

### Internal Block Diagram

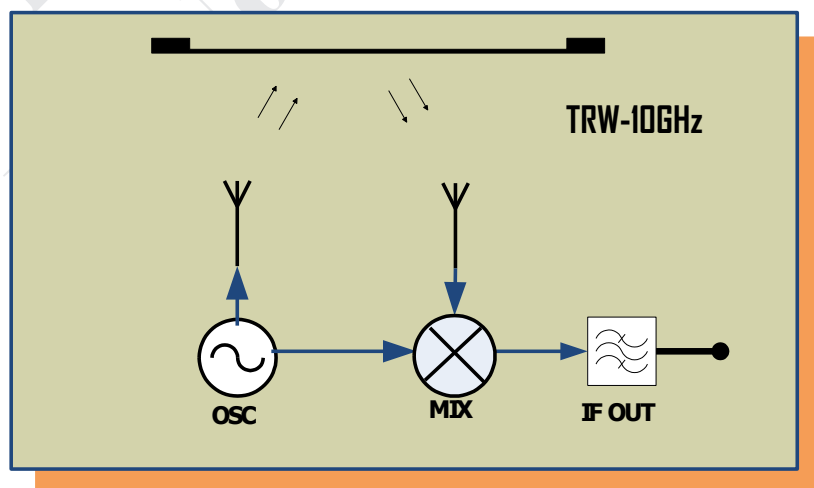

## Pin Assignment

Pin	Description	Typical Value
1	GND	
2	IF	load 10k Ohm
3	GND	
4	GND	
5	GND	
6	VCC	5Vdc supply

## Dimension

(unit: mm)

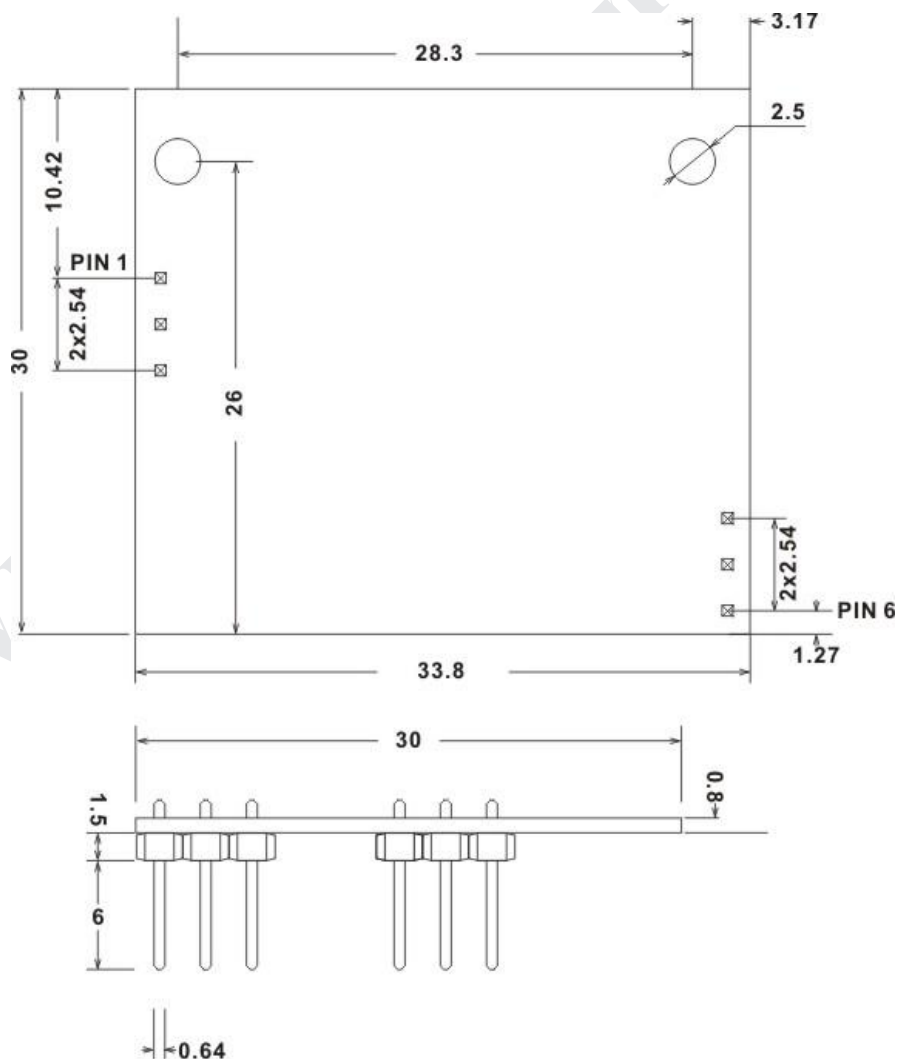

All Dimensions in mm

# Circuit Example

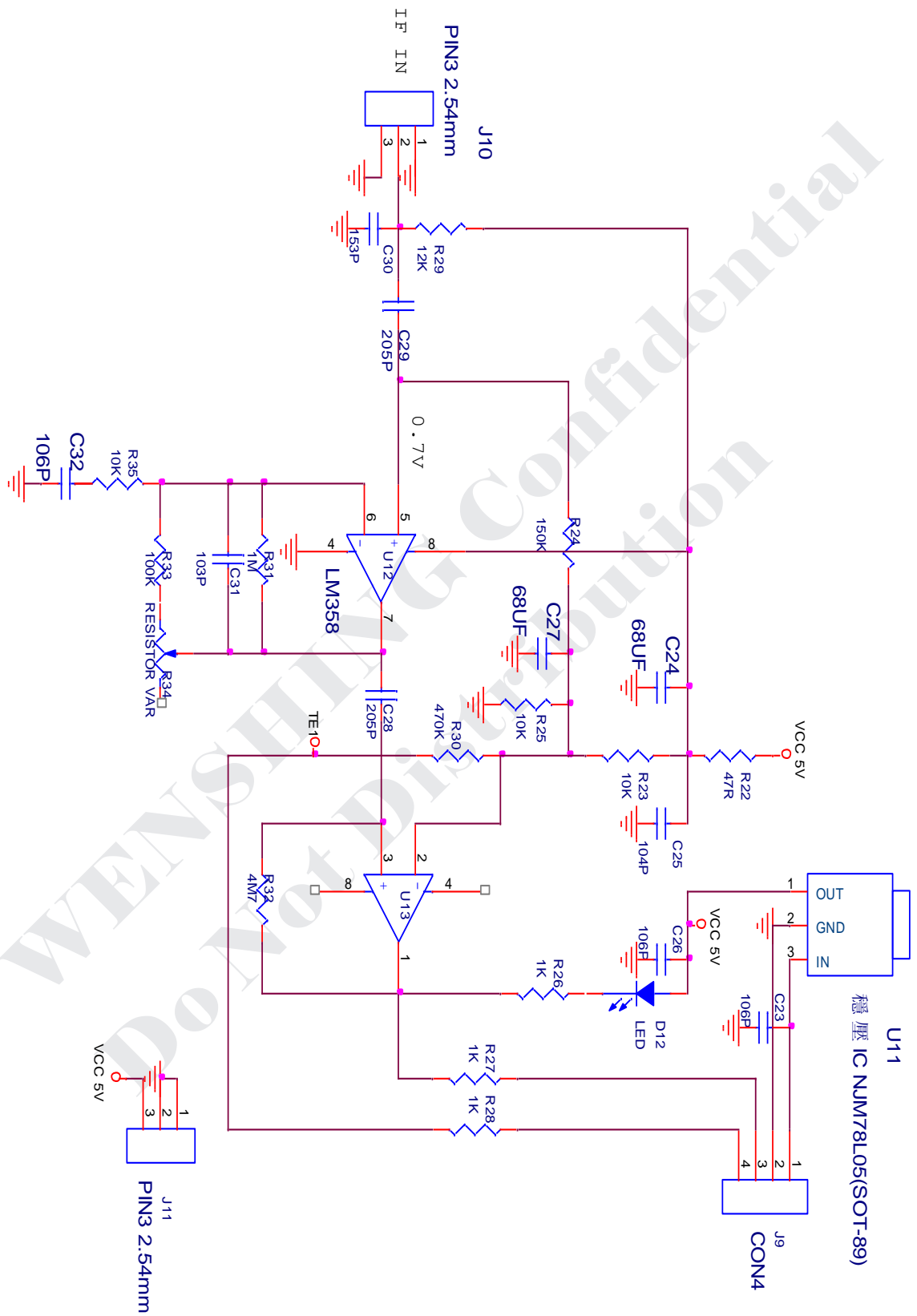

# TRW-10GHz Control End

## Application Specification (Control Side)

When module which is as control pane to use in combination, it can be used in automatic door installations. When people close to installations, RELAY will be automatically action around 5 seconds; through setting, you can set distance according to your need, it is easy for use.

## Application

- Automatic door opener
- Security system
- Automatic light sensor
- Staircase & aisle light
- Turf sensor light
- Parking light control
- Traffic light signal control

## Electrical Specification

Parameter	Specification			Unit	Condition
	Min	Type	Max		
Supply Voltage, VDD	9		12	V	AC/DC
Relay Switching Voltage			125	V	AC
Relay Switching Voltage			30	V	DC
Relay Switching Current			1	A	
Standby Current			52	mA	12VAC

## Circuit Connection

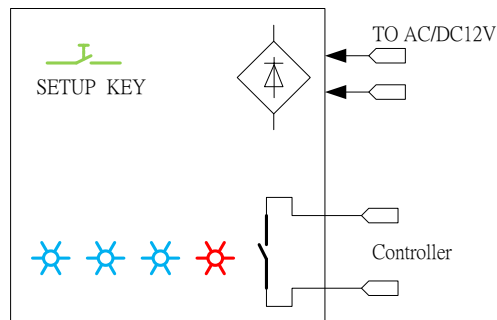

## Dimension

(unit: mm)

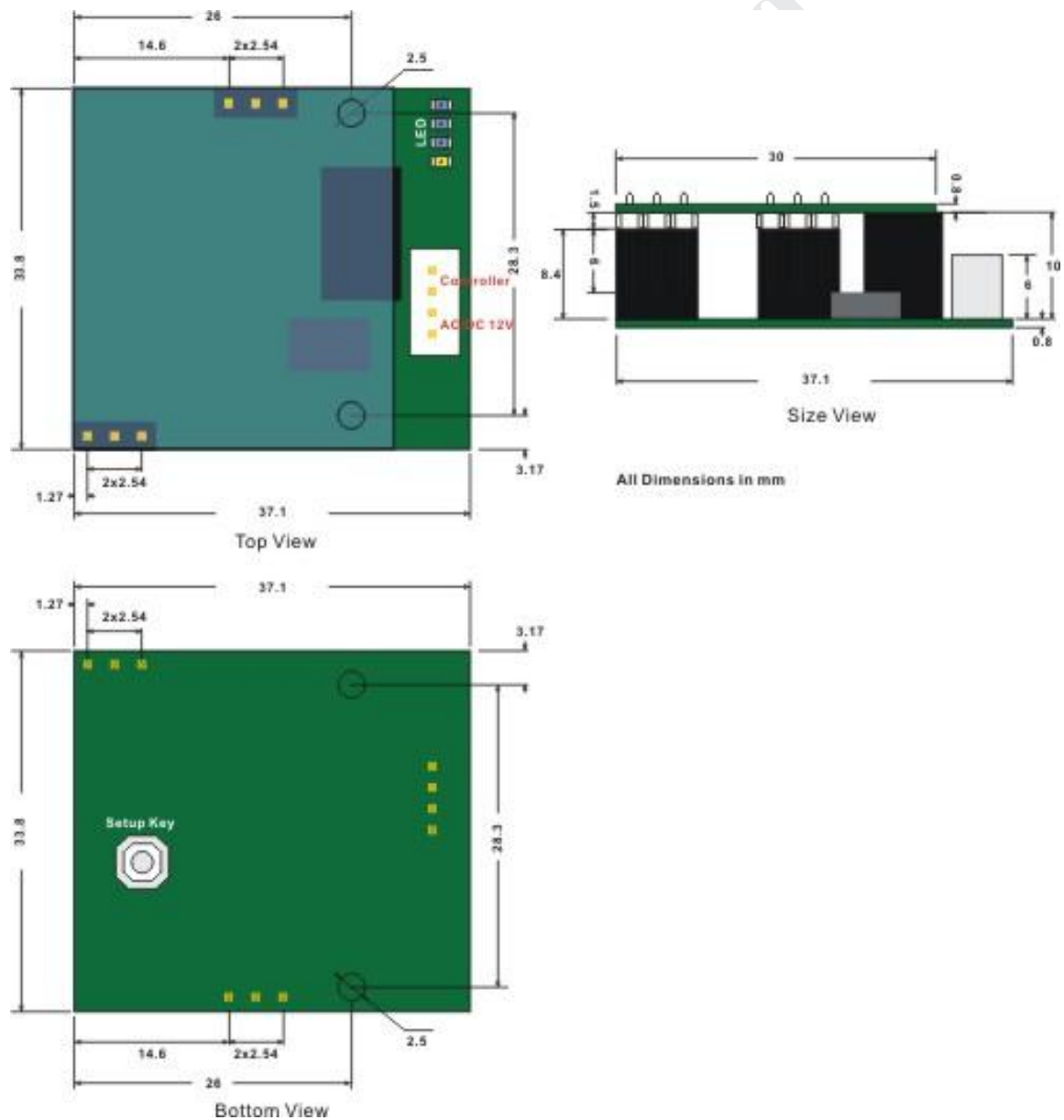







## Operation

### Distance setting

Press the set button for 2 seconds and LED1, LED2, LED3 start blinking, it is meaning that it is into the distance setting mode. When LED stops blinking, LED shows current status which stored in the internal configuration. To re-set the action, please use the button to adjust required distance. It will automatically switch distance setting when you press button every time, please check distance setting details as following table. If you hope to leave setting mode after finished setting, please press the button and wait until LED start flash. Then, you can leave the button and it will auto-save settings and switch to standby mode.

 = Lights     = Lights out







LED Display	Distance Meter	Application
		The farthest and use for light controller
		
		
		
		
		
		Shortest



## 🔘 Action time setting

Press the set button for 2 seconds and LED1, LED2, LED3 start blinking, it is meaning that it is into the distance setting mode. When LED stops blinking, LED shows current status which stored in the internal configuration. To re-set the action, please use the button to adjust required distance. It will automatically switch distance setting when you press button every time, please check distance setting details as following table. If you hope to leave setting mode after finished setting, please press the button and wait until LED start flash. Then, you can leave the button and it will auto-save settings and switch to standby mode.

 = Lights     = Lights out

LED Display	Time	Application
	20 Minutes	Garage door or light controller
	10 Minutes	
	5 Minutes	Parking lane
	1 Minute	
	10 Seconds	
	5 Seconds	
	1 Second	Automatic door connection control