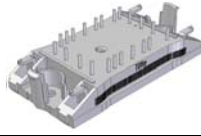
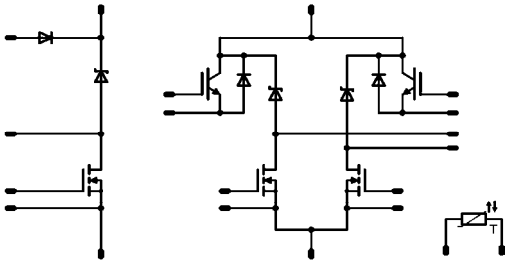

flowSOL BI	600V/35A
<div style="border: 1px solid black; padding: 5px; margin-bottom: 5px;"> <p style="text-align: center; background-color: #000080; color: white; margin: 0;">Features</p> <ul style="list-style-type: none"> High efficiency Ultra fast switching frequency Low inductive design Open emitter SiC in boost and H bridge </div> <div style="border: 1px solid black; padding: 5px; margin-bottom: 5px;"> <p style="text-align: center; background-color: #000080; color: white; margin: 0;">Target Applications</p> <ul style="list-style-type: none"> Transformerless solar inverters </div> <div style="border: 1px solid black; padding: 5px;"> <p style="text-align: center; background-color: #000080; color: white; margin: 0;">Types</p> <ul style="list-style-type: none"> FZ06BIA045FH02 </div>	<div style="border: 1px solid black; padding: 5px; margin-bottom: 5px;"> <p style="text-align: center; background-color: #000080; color: white; margin: 0;">flow0 housing</p>  </div> <div style="border: 1px solid black; padding: 5px;"> <p style="text-align: center; background-color: #000080; color: white; margin: 0;">Schematic</p>  </div>

Maximum Ratings

T_j=25°C, unless otherwise specified

Parameter	Symbol	Condition	Value	Unit	
Bypass Diode					
Repetitive peak reverse voltage	V _{RRM}		600	V	
Forward current per diode	I _{FAV}	DC current	T _n =80°C T _c =80°C	36 49	A
Surge forward current	I _{FSM}	t _p =10ms	T _j =25°C	370	A
I ² t-value	I ² t			360	A ² s
Power dissipation per Diode	P _{tot}	T _j =T _{jmax}	T _n =80°C T _c =80°C	42 63	W
Maximum Junction Temperature	T _{jmax}			150	°C
Input Boost MOSFET					
Drain to source breakdown voltage	V _{DS}			600	V
DC drain current	I _D	T _j =T _{jmax}	T _n =80°C T _c =80°C	30 37	A
Pulsed drain current	I _{Dpulse}	t _p limited by T _{jmax}		230	A
Power dissipation	P _{tot}	T _j =T _{jmax}	T _n =80°C T _c =80°C	92 139	W
Gate-source peak voltage	V _{GS}			±20	V
Maximum Junction Temperature	T _{jmax}			150	°C

Maximum Ratings

 $T_j=25^{\circ}\text{C}$, unless otherwise specified

Parameter	Symbol	Condition	Value	Unit	
Input Boost Diode					
Peak Repetitive Reverse Voltage	V_{RRM}	$T_j=25^{\circ}\text{C}$	600	V	
DC forward current	I_F	$T_j=T_{jmax}$	$T_h=80^{\circ}\text{C}$	20	A
			$T_c=80^{\circ}\text{C}$	24	
Repetitive peak forward current	I_{FRM}	t_p limited by T_{jmax}	70	A	
Power dissipation	P_{tot}	$T_j=T_{jmax}$	$T_h=80^{\circ}\text{C}$	41	W
			$T_c=80^{\circ}\text{C}$	62	
Maximum Junction Temperature	T_{jmax}		175	$^{\circ}\text{C}$	
Buck Diode					
Peak Repetitive Reverse Voltage	V_{RRM}	$T_j=25^{\circ}\text{C}$	600	V	
DC forward current	I_F	$T_j=T_{jmax}$	$T_h=80^{\circ}\text{C}$	13	A
			$T_c=80^{\circ}\text{C}$	16	
Repetitive peak forward current	I_{FRM}	t_p limited by T_{jmax}	$T_c=100^{\circ}\text{C}$	35	A
Power dissipation per Diode	P_{tot}	$T_j=T_{jmax}$	$T_h=80^{\circ}\text{C}$	29	W
			$T_c=80^{\circ}\text{C}$	44	
Maximum Junction Temperature	T_{jmax}		175	$^{\circ}\text{C}$	
Buck MOSFET					
Drain to source breakdown voltage	V_{DS}		600	V	
DC drain current	I_D	$T_j=T_{jmax}$	$T_h=80^{\circ}\text{C}$	30	A
			$T_c=80^{\circ}\text{C}$	37	
Pulsed drain current	I_{Dpulse}	t_p limited by T_{jmax}	$T_c=25^{\circ}\text{C}$	230	A
Power dissipation	P_{tot}	$T_j=T_{jmax}$	$T_h=80^{\circ}\text{C}$	94	W
			$T_c=80^{\circ}\text{C}$	142	
Gate-source peak voltage	V_{GS}		± 20	V	
Maximum Junction Temperature	T_{jmax}		150	$^{\circ}\text{C}$	
Boost IGBT					
Collector-emitter break down voltage	V_{CE}		600	V	
DC collector current	I_C	$T_j=T_{jmax}$	$T_h=80^{\circ}\text{C}$	40	A
			$T_c=80^{\circ}\text{C}$	40	
Repetitive peak collector current	I_{Cpuls}	t_p limited by T_{jmax}		150	A
Power dissipation per IGBT	P_{tot}	$T_j=T_{jmax}$	$T_h=80^{\circ}\text{C}$	86	W
			$T_c=80^{\circ}\text{C}$	131	
Gate-emitter peak voltage	V_{GE}		± 20	V	
Short circuit ratings	t_{SC}	$T_j \leq 150^{\circ}\text{C}$	6	μs	
	V_{CC}	$V_{GE}=15\text{V}$	360	V	
Maximum Junction Temperature	T_{jmax}		175	$^{\circ}\text{C}$	

Maximum Ratings

 $T_j=25^{\circ}\text{C}$, unless otherwise specified

Parameter	Symbol	Condition	Value	Unit
Boost Inverse Diode				
Peak Repetitive Reverse Voltage	V_{RRM}	$T_c=25^{\circ}\text{C}$	600	V
DC forward current	I_F	$T_j=T_{jmax}$	16	A
		$T_h=80^{\circ}\text{C}$ $T_c=80^{\circ}\text{C}$	20	
Repetitive peak forward current	I_{FRM}	t_p limited by T_{jmax}	20	A
Power dissipation per Diode	P_{tot}	$T_j=T_{jmax}$	32	W
		$T_h=80^{\circ}\text{C}$ $T_c=80^{\circ}\text{C}$	49	
Maximum Junction Temperature	T_{jmax}		175	$^{\circ}\text{C}$

Thermal Properties

Storage temperature	T_{stg}		-40...+125	$^{\circ}\text{C}$
Operation temperature under switching condition	T_{op}		-40...+($T_{jmax} - 25$)	$^{\circ}\text{C}$

Insulation Properties

Insulation voltage	V_{is}	$t=2\text{s}$ DC voltage	4000	V
Creepage distance			min 12,7	mm
Clearance			min 12,7	mm

Characteristic Values

Parameter	Symbol	Conditions					Value			Unit
		$V_{GE}[V]$ or $V_{GS}[V]$	$V_r[V]$ or $V_{CE}[V]$ or $V_{DS}[V]$	$I_c[A]$ or $I_F[A]$ or $I_D[A]$	T_j	Min	Typ	Max		
Bypass Diode										
Forward voltage	solar invert				15	$T_j=25^\circ C$ $T_j=125^\circ C$	0,7	1,01 0,93	1,3	V
Threshold voltage (for power loss calc. only)	V_{th}					$T_j=25^\circ C$ $T_j=125^\circ C$		0,86 0,75		V
Slope resistance (for power loss calc. only)	r_t					$T_j=25^\circ C$ $T_j=125^\circ C$		0,01 0,01		Ω
Reverse current	I_r			1200		$T_j=25^\circ C$ $T_j=125^\circ C$			0,05	mA
Thermal resistance chip to heatsink per chip	R_{thJH}	Thermal foil thickness=76um Kunze foil KU-ALF5						1,68		K/W
Input Boost MOSFET										
Static drain to source ON resistance	$R_{DS(on)}$		10		44	$T_j=25^\circ C$ $T_j=125^\circ C$		0,04 0,09		Ω
Gate threshold voltage	$V_{(GS)th}$	VGS=VDS			0,003	$T_j=25^\circ C$ $T_j=125^\circ C$	2,1	3	3,9	V
Gate to Source Leakage Current	I_{gss}		20	0		$T_j=25^\circ C$ $T_j=125^\circ C$			200	nA
Zero Gate Voltage Drain Current	I_{dss}		0	600		$T_j=25^\circ C$ $T_j=125^\circ C$			25000	nA
Turn On Delay Time	$t_{d(ON)}$					$T_j=25^\circ C$ $T_j=125^\circ C$		28 27		ns
Rise Time	t_r					$T_j=25^\circ C$ $T_j=125^\circ C$		5 6		
Turn off delay time	$t_{d(OFF)}$	Rgoff=4 Ω	10	400	15	$T_j=25^\circ C$ $T_j=125^\circ C$		154 167		
Fall time	t_f	Rgon=4 Ω				$T_j=25^\circ C$ $T_j=125^\circ C$		10 9		
Turn-on energy loss per pulse	E_{on}					$T_j=25^\circ C$ $T_j=125^\circ C$		0,063 0,072		mWs
Turn-off energy loss per pulse	E_{off}					$T_j=25^\circ C$ $T_j=125^\circ C$		0,025 0,025		
Total gate charge	Q_g					$T_j=25^\circ C$ $T_j=125^\circ C$		150	190	nC
Gate to source charge	Q_{gs}	Rgon=4 Ω	10	400	44	$T_j=25^\circ C$ $T_j=125^\circ C$		34		
Gate to drain charge	Q_{gd}					$T_j=25^\circ C$ $T_j=125^\circ C$		51		
Input capacitance	C_{iss}							6800		pF
Output capacitance	C_{oss}	f=1MHz	0	100		$T_j=25^\circ C$		320		
Reverse transfer capacitance	C_{rss}							48		
Thermal resistance chip to heatsink per chip	R_{thJH}	Thermal grease thickness \leq 50um $\lambda = 1$ W/mK						0,76		K/W
Input Boost Diode										
Forward voltage	V_F				16	$T_j=25^\circ C$ $T_j=150^\circ C$	1	1,54 1,71	1,8	V
Reverse leakage current	I_{rm}		10	400	15	$T_j=25^\circ C$ $T_j=150^\circ C$			400	μA
Peak recovery current	I_{RRM}					$T_j=25^\circ C$ $T_j=150^\circ C$		16,63 14,68		A
Reverse recovery time	t_{rr}					$T_j=25^\circ C$ $T_j=150^\circ C$		9,3 10,4		ns
Reverse recovery charge	Q_{rr}	Rgon=4 Ω	10	400	15	$T_j=25^\circ C$ $T_j=150^\circ C$		0,058 0,064		μC
Reverse recovered energy	E_{rec}					$T_j=25^\circ C$ $T_j=150^\circ C$		0,005 0,006		mWs
Peak rate of fall of recovery current	$di(rec)max/dt$					$T_j=25^\circ C$ $T_j=150^\circ C$		4244 2752		A/ μs
Thermal resistance chip to heatsink per chip	R_{thJH}	Thermal grease thickness \leq 50um $\lambda = 1$ W/mK						2,34		K/W

Characteristic Values

Parameter	Symbol	Conditions					Value			Unit	
		$V_{GE}[V]$ or $V_{GS}[V]$	$V_r[V]$ or $V_{CE}[V]$ or $V_{DS}[V]$	$I_c[A]$ or $I_F[A]$ or $I_D[A]$	T_j	Min	Typ	Max			
Buck Diode											
Diode forward voltage	V_F				8	$T_j=25^\circ C$ $T_j=125^\circ C$	1	1,52 1,64	1,8	V	
Peak reverse recovery current	I_{RRM}	Rgon=4 Ω	10	400	15	$T_j=25^\circ C$ $T_j=125^\circ C$		14 12		A	
Reverse recovery time	t_{rr}					$T_j=25^\circ C$ $T_j=125^\circ C$		7,8 8,8		ns	
Reverse recovered charge	Q_{rr}					$T_j=25^\circ C$ $T_j=125^\circ C$		0,05 0,05		μC	
Peak rate of fall of recovery current	$di(rec)max/dt$					$T_j=25^\circ C$ $T_j=125^\circ C$		4078 3373		A/ μs	
Reverse recovered energy	Erec					$T_j=25^\circ C$ $T_j=125^\circ C$		0,008 0,007		mWs	
Thermal resistance chip to heatsink per chip	R_{thJH}					Thermal grease thickness $\leq 50\mu m$ $\lambda = 1 W/mK$					3,28
Buck MOSFET											
Static drain to source ON resistance	$R_{ds(on)}$		10		44	$T_j=25^\circ C$ $T_j=125^\circ C$		45 90		m Ω	
Gate threshold voltage	$V_{(GS)th}$			$V_{DS}=V_{GS}$	0,003	$T_j=25^\circ C$ $T_j=125^\circ C$	2,1	3	3,9	V	
Gate to Source Leakage Current	I_{gss}		20	0		$T_j=25^\circ C$ $T_j=125^\circ C$			200	nA	
Zero Gate Voltage Drain Current	I_{dss}		0	600		$T_j=25^\circ C$ $T_j=125^\circ C$			25000	nA	
Turn On Delay Time	$t_{d(ON)}$	Rgoff=4 Ω Rgon=4 Ω	10	400	15	$T_j=25^\circ C$ $T_j=125^\circ C$		31 30		ns	
Rise Time	t_r					$T_j=25^\circ C$ $T_j=125^\circ C$		5,4 6			
Turn off delay time	$t_{d(OFF)}$					$T_j=25^\circ C$ $T_j=125^\circ C$		147 158			
Fall time	t_f					$T_j=25^\circ C$ $T_j=125^\circ C$		13,7 10,3			
Turn-on energy loss per pulse	E_{on}					$T_j=25^\circ C$ $T_j=125^\circ C$		0,063 0,067			mWs
Turn-off energy loss per pulse	E_{off}					$T_j=25^\circ C$ $T_j=125^\circ C$		0,02 0,03			
Total gate charge	Q_g							150	190	nC	
Gate to source charge	Q_{gs}		10	400	44	$T_j=25^\circ C$		34			
Gate to drain charge	Q_{gd}							51			
Input capacitance	C_{iss}							6800		pF	
Output capacitance	C_{oss}	f=1MHz	0	100		$T_j=25^\circ C$		320			
Reverse transfer capacitance	C_{rss}							48			
Thermal resistance chip to heatsink per chip	R_{thJH}	Thermal grease thickness $\leq 50\mu m$ $\lambda = 1 W/mK$						0,75		K/W	

Characteristic Values

Parameter	Symbol	Conditions					Value			Unit
		$V_{GE}[V]$ or $V_{GS}[V]$	$V_r[V]$ or $V_{CE}[V]$ or $V_{DS}[V]$	$I_c[A]$ or $I_F[A]$ or $I_D[A]$	T_j	Min	Typ	Max		

Boost IGBT

Gate emitter threshold voltage	$V_{GE(th)}$	$V_{CE}=V_{GE}$			0,0008	$T_j=25^\circ C$ $T_j=125^\circ C$	5	5,8	6,5	V
Collector-emitter saturation voltage	$V_{CE(sat)}$		15		50	$T_j=25^\circ C$ $T_j=125^\circ C$		1,18 1,21		V
Collector-emitter cut-off incl diode	I_{CES}		0	600		$T_j=25^\circ C$ $T_j=125^\circ C$			0,03	mA
Gate-emitter leakage current	I_{GES}		20	0		$T_j=25^\circ C$ $T_j=125^\circ C$			650	nA
Integrated Gate resistor	R_{gint}							none		Ω
Input capacitance	C_{ies}							3140		pF
Output capacitance	C_{oss}	f=1MHz	0	25		$T_j=25^\circ C$		200		
Reverse transfer capacitance	C_{rss}							93		
Gate charge	Q_{Gate}		15	480	50	$T_j=25^\circ C$		310		nC
Thermal resistance chip to heatsink per chip	R_{thJH}	Thermal grease thickness $\leq 50\mu m$ $\lambda = 1 W/mK$						1,1		K/W

 Note: For the **Boost IGBT** only LF switching allowed

Boost Inverse Diode

Diode forward voltage	V_F				10	$T_j=25^\circ C$ $T_j=125^\circ C$		1,68 1,63		V
Thermal resistance chip to heatsink per chip	R_{thJH}	Thermal grease thickness $\leq 50\mu m$ $\lambda = 1 W/mK$						2,949		K/W

Thermistor

Rated resistance*	R_{25}					$T_j=25^\circ C$	17,5	22	29,0	k Ω
	R_{100}	Tol. $\pm 5\%$						1486		Ω
Power dissipation	P					$T_j=25^\circ C$		210		mW
B-value	$B_{(25/100)}$	Tol. $\pm 3\%$				$T_j=25^\circ C$		4000		K

 * see details on **Thermistor** charts on **Figure 2**.

Buck

Figure 1 MOSFET

Typical output characteristics

$I_C = f(V_{CE})$

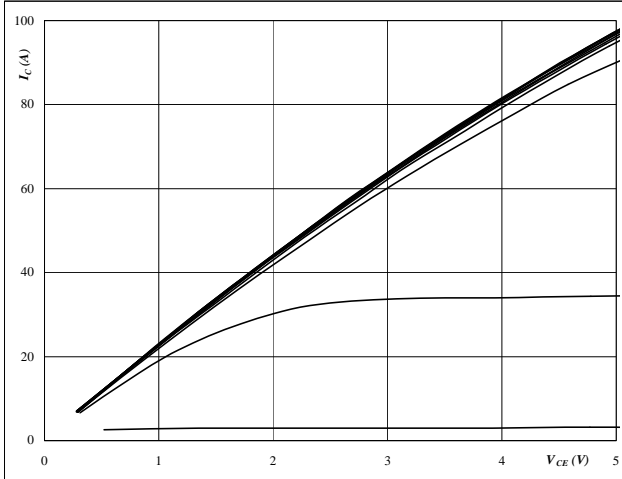

At
 $t_p = 250 \mu s$
 $T_j = 25 \text{ }^\circ C$
 V_{GE} from 4 V to 14 V in steps of 1 V

Figure 2 MOSFET

Typical output characteristics

$I_C = f(V_{CE})$

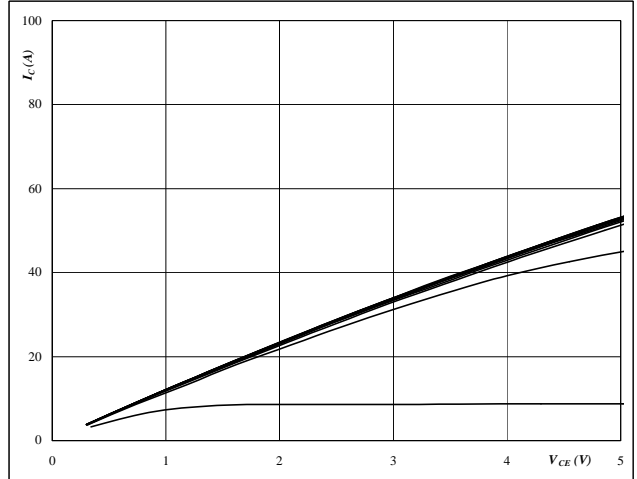

At
 $t_p = 250 \mu s$
 $T_j = 125 \text{ }^\circ C$
 V_{GE} from 4 V to 14 V in steps of 1 V

Figure 3 MOSFET

Typical transfer characteristics

$I_C = f(V_{GE})$

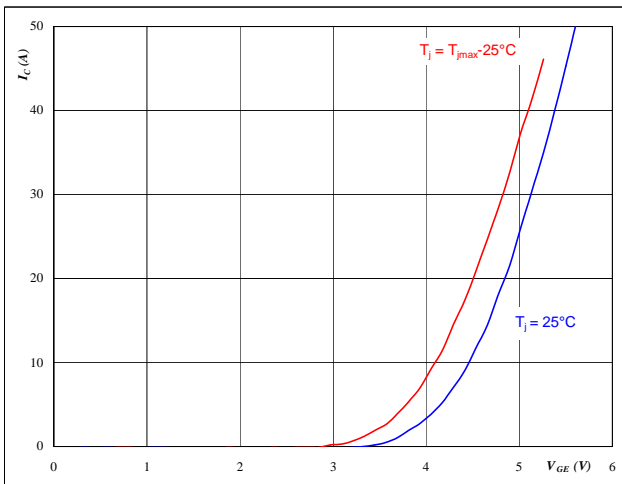

At
 $t_p = 250 \mu s$
 $V_{CE} = 10 V$

Figure 4 FRED

Typical diode forward current as a function of forward voltage

$I_F = f(V_F)$

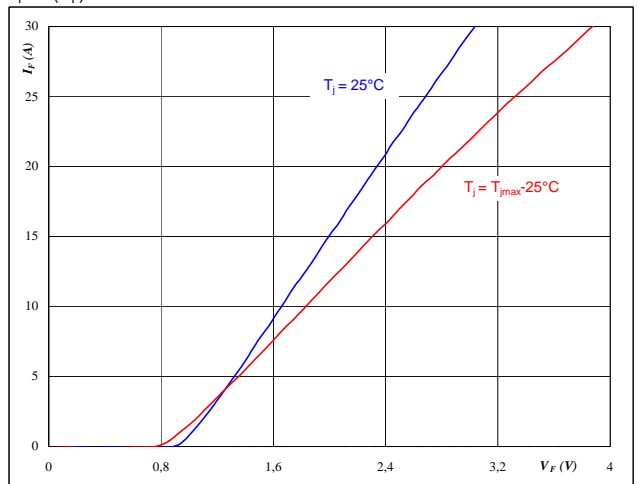

At
 $t_p = 250 \mu s$

Buck

Figure 5 MOSFET

Typical switching energy losses as a function of collector current

$$E = f(I_c)$$

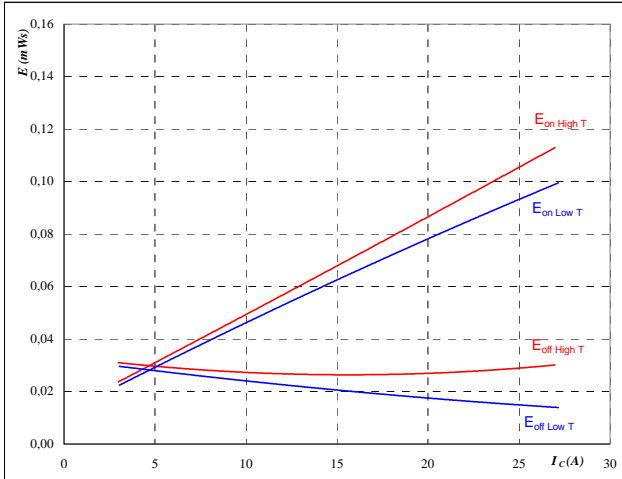

With an inductive load at

$T_j =$	25/125	°C
$V_{CE} =$	400	V
$V_{GE} =$	10	V
$R_{gon} =$	4	Ω
$R_{goff} =$	4	Ω

Figure 6 MOSFET

Typical switching energy losses as a function of gate resistor

$$E = f(R_g)$$

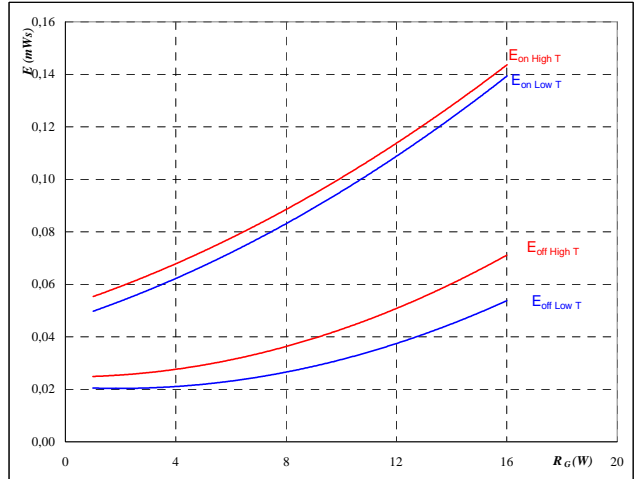

With an inductive load at

$T_j =$	25/125	°C
$V_{CE} =$	400	V
$V_{GE} =$	10	V
$I_c =$	15	A

Figure 7 FRED

Typical reverse recovery energy loss as a function of collector current

$$E_{rec} = f(I_c)$$

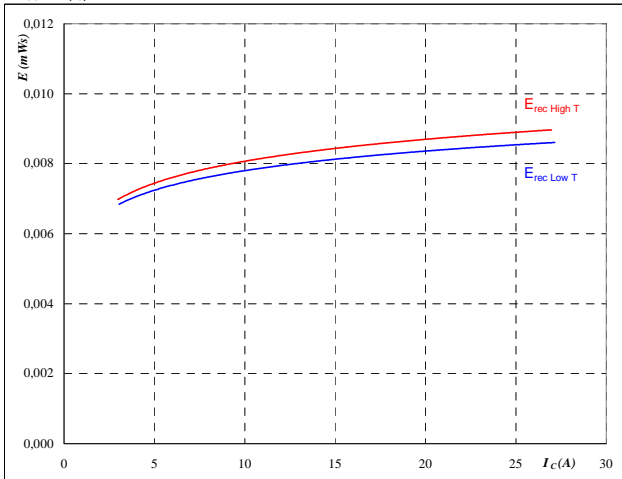

With an inductive load at

$T_j =$	25/125	°C
$V_{CE} =$	400	V
$V_{GE} =$	10	V
$R_{gon} =$	4	Ω

Figure 8 FRED

Typical reverse recovery energy loss as a function of gate resistor

$$E_{rec} = f(R_g)$$

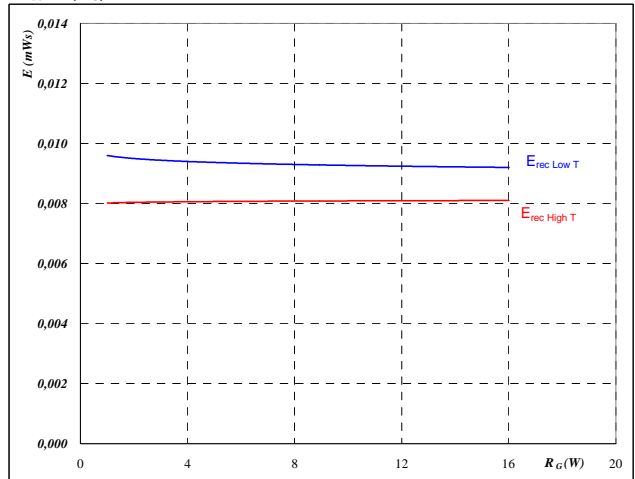

With an inductive load at

$T_j =$	25/125	°C
$V_{CE} =$	400	V
$V_{GE} =$	10	V
$I_c =$	15	A

Buck

Figure 9 MOSFET

Typical switching times as a function of collector current

$$t = f(I_C)$$

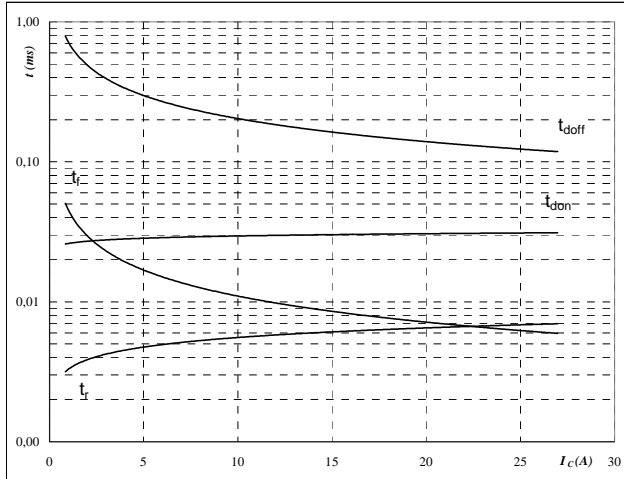

With an inductive load at

$T_j =$	125	°C
$V_{CE} =$	400	V
$V_{GE} =$	10	V
$R_{gon} =$	4	Ω
$R_{goff} =$	4	Ω

Figure 10 MOSFET

Typical switching times as a function of gate resistor

$$t = f(R_G)$$

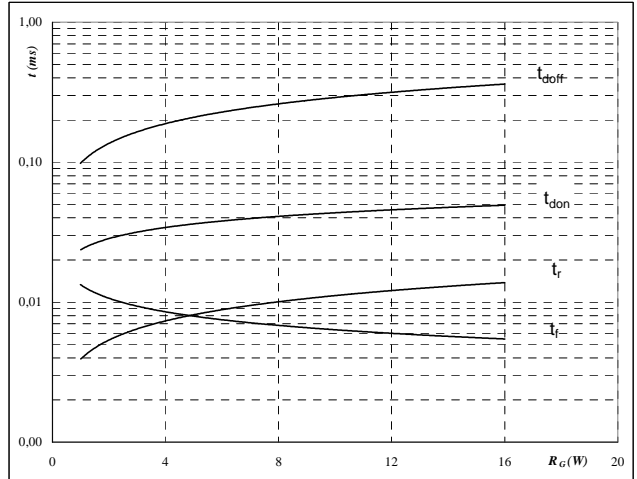

With an inductive load at

$T_j =$	125	°C
$V_{CE} =$	400	V
$V_{GE} =$	10	V
$I_C =$	15	A

Figure 11 FRED

Typical reverse recovery time as a function of collector current

$$t_{rr} = f(I_C)$$

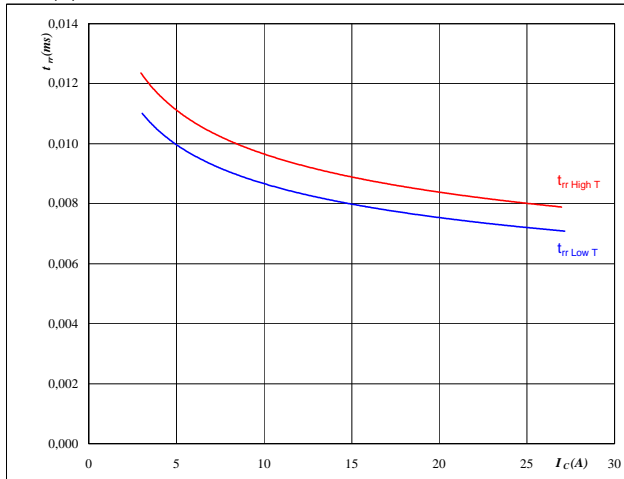

At

$T_j =$	25/125	°C
$V_{CE} =$	400	V
$V_{GE} =$	10	V
$R_{gon} =$	4	Ω

Figure 12 FRED

Typical reverse recovery time as a function of IGBT turn on gate resistor

$$t_{rr} = f(R_{gon})$$

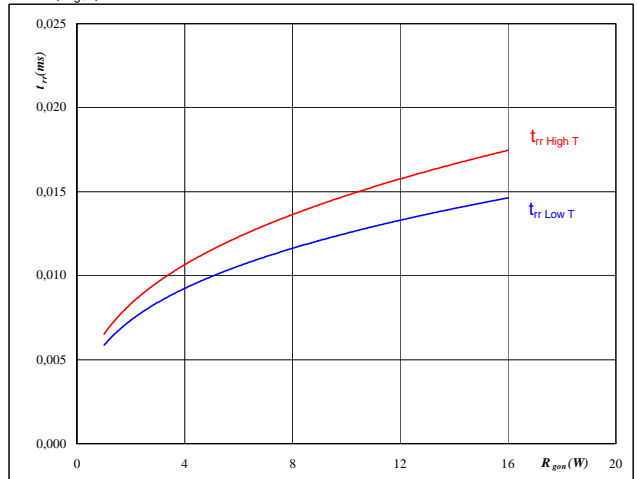

At

$T_j =$	25/125	°C
$V_R =$	400	V
$I_F =$	15	A
$V_{GE} =$	10	V

Buck

Figure 13 FRED

Typical reverse recovery charge as a function of collector current

$$Q_{rr} = f(I_C)$$

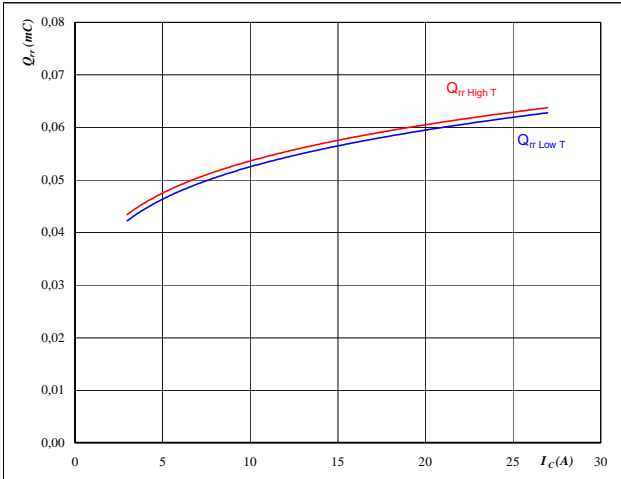

At
 $T_j = 25/125 \text{ } ^\circ\text{C}$
 $V_{CE} = 400 \text{ V}$
 $V_{GE} = 10 \text{ V}$
 $R_{gon} = 4 \text{ } \Omega$

Figure 14 FRED

Typical reverse recovery charge as a function of IGBT turn on gate resistor

$$Q_{rr} = f(R_{gon})$$

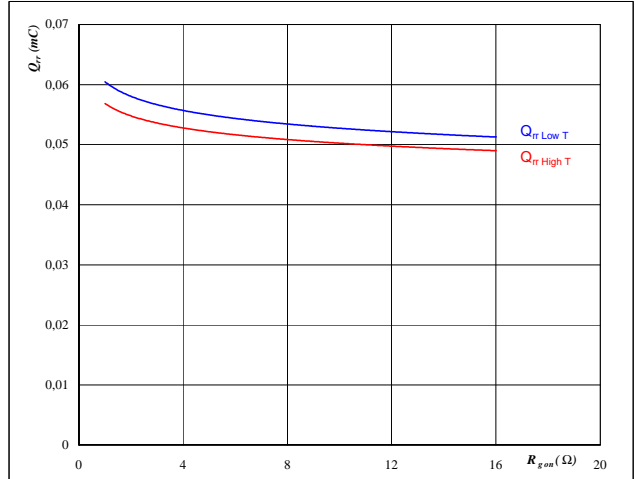

At
 $T_j = 25/125 \text{ } ^\circ\text{C}$
 $V_R = 400 \text{ V}$
 $I_F = 15 \text{ A}$
 $V_{GE} = 10 \text{ V}$

Figure 15 FRED

Typical reverse recovery current as a function of collector current

$$I_{RRM} = f(I_C)$$

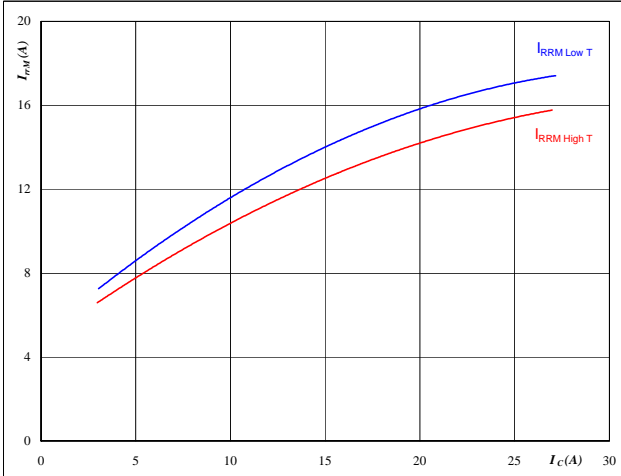

At
 $T_j = 25/125 \text{ } ^\circ\text{C}$
 $V_{CE} = 400 \text{ V}$
 $V_{GE} = 10 \text{ V}$
 $R_{gon} = 4 \text{ } \Omega$

Figure 16 FRED

Typical reverse recovery current as a function of IGBT turn on gate resistor

$$I_{RRM} = f(R_{gon})$$

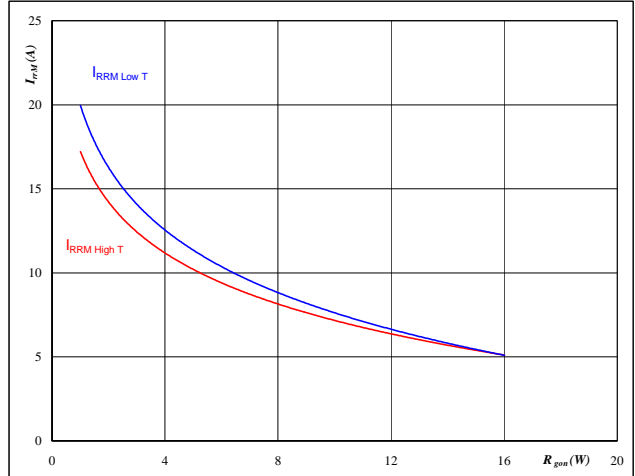

At
 $T_j = 25/125 \text{ } ^\circ\text{C}$
 $V_R = 400 \text{ V}$
 $I_F = 15 \text{ A}$
 $V_{GE} = 10 \text{ V}$

Buck

Figure 17 FRED

Typical rate of fall of forward and reverse recovery current as a function of collector current

$$dI_f/dt, dI_{rec}/dt = f(I_c)$$

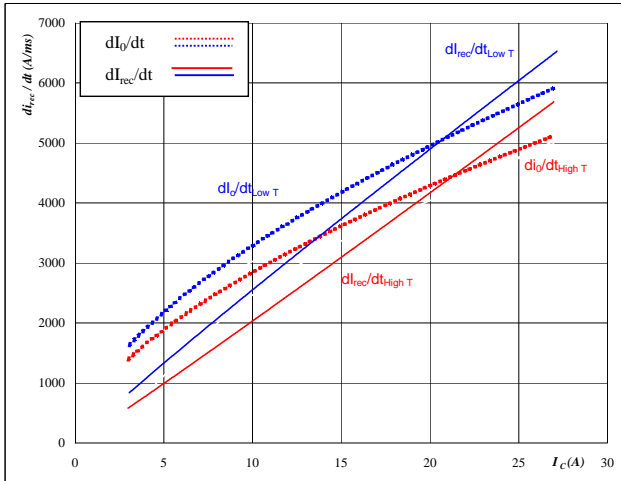

At
 $T_j = 25/125 \text{ } ^\circ\text{C}$
 $V_{CE} = 400 \text{ V}$
 $V_{GE} = 10 \text{ V}$
 $R_{gon} = 4 \text{ } \Omega$

Figure 18 FRED

Typical rate of fall of forward and reverse recovery current as a function of IGBT turn on gate resistor

$$dI_f/dt, dI_{rec}/dt = f(R_{gon})$$

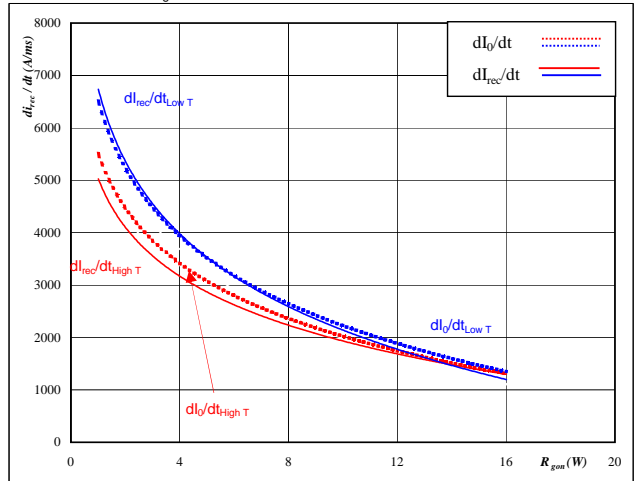

At
 $T_j = 25/125 \text{ } ^\circ\text{C}$
 $V_R = 400 \text{ V}$
 $I_F = 15 \text{ A}$
 $V_{GE} = 10 \text{ V}$

Figure 19 MOSFET

IGBT transient thermal impedance as a function of pulse width

$$Z_{thJH} = f(t_p)$$

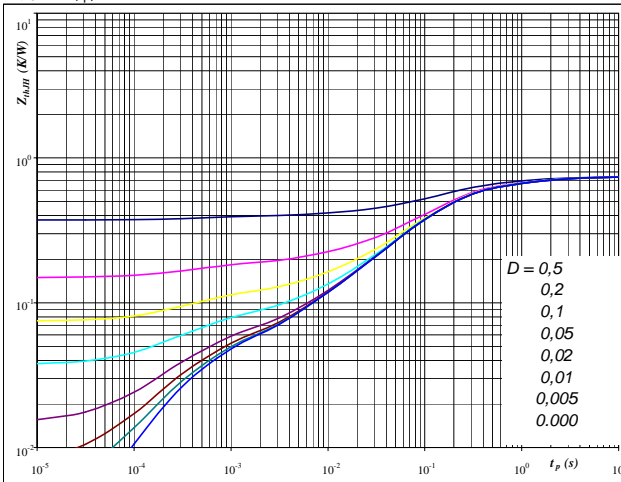

At
 $D = t_p / T$
 $R_{thJH} = 0,75 \text{ K/W}$

IGBT thermal model values

R (C/W)	Tau (s)
0,03	9,3E+00
0,12	1,2E+00
0,41	1,6E-01
0,11	3,8E-02
0,03	5,2E-03
0,04	3,7E-04

Figure 20 FRED

FRED transient thermal impedance as a function of pulse width

$$Z_{thJH} = f(t_p)$$

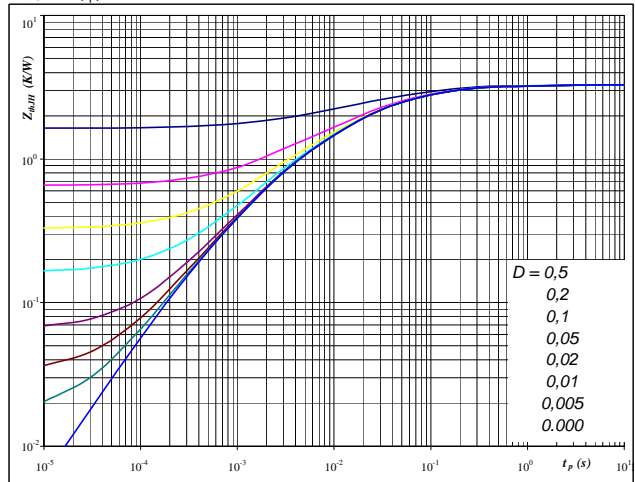

At
 $D = t_p / T$
 $R_{thJH} = 3,28 \text{ K/W}$

FRED thermal model values

R (C/W)	Tau (s)
0,17	9,7E-01
1,04	8,5E-02
1,34	1,6E-02
0,65	2,5E-03
0,08	3,2E-04

Buck

Figure 21 MOSFET

Power dissipation as a function of heatsink temperature

$$P_{tot} = f(T_h)$$



At
 $T_j = 150$ °C

Figure 22 MOSFET

Collector current as a function of heatsink temperature

$$I_C = f(T_h)$$

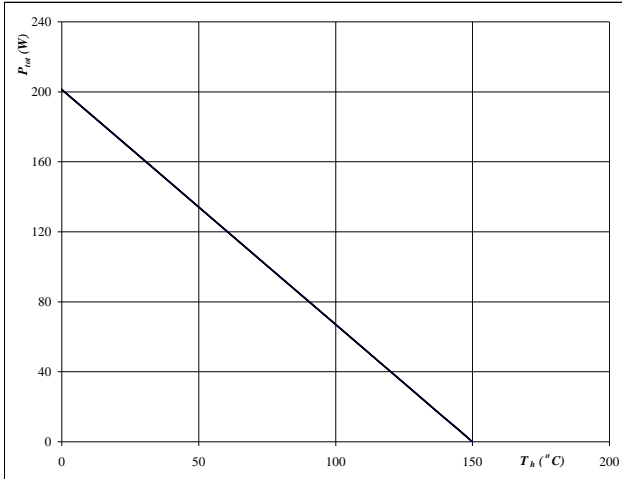

At
 $T_j = 150$ °C
 $V_{GE} = 15$ V

Figure 23 FRED

Power dissipation as a function of heatsink temperature

$$P_{tot} = f(T_h)$$

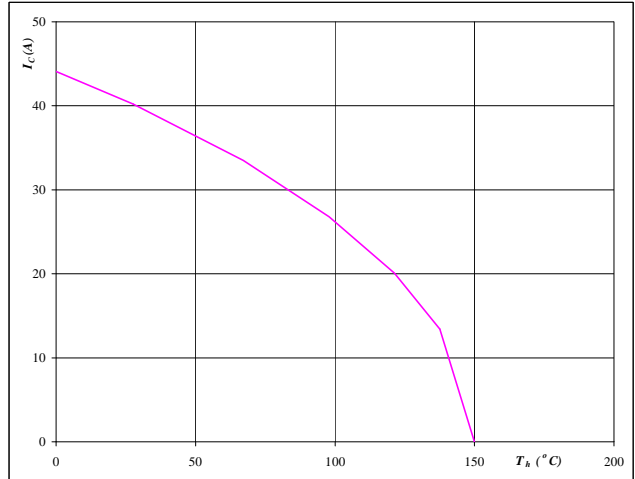

At
 $T_j = 175$ °C

Figure 24 FRED

Forward current as a function of heatsink temperature

$$I_F = f(T_h)$$

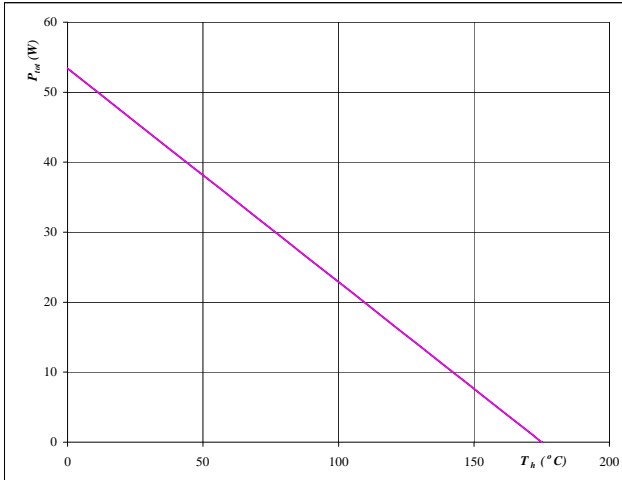
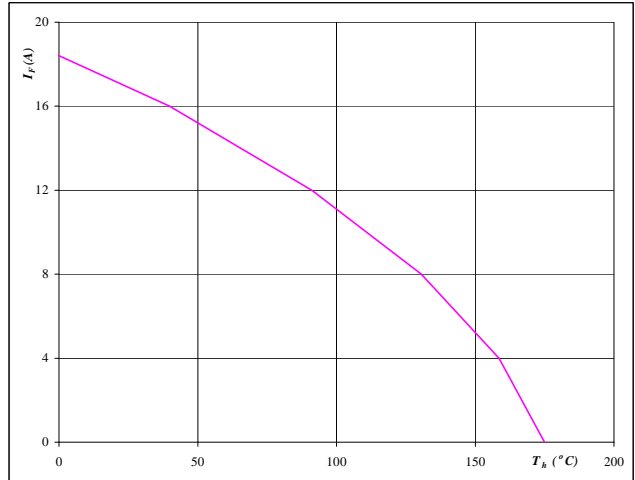

At
 $T_j = 175$ °C

Buck

Figure 25 MOSFET

Safe operating area as a function of collector-emitter voltage

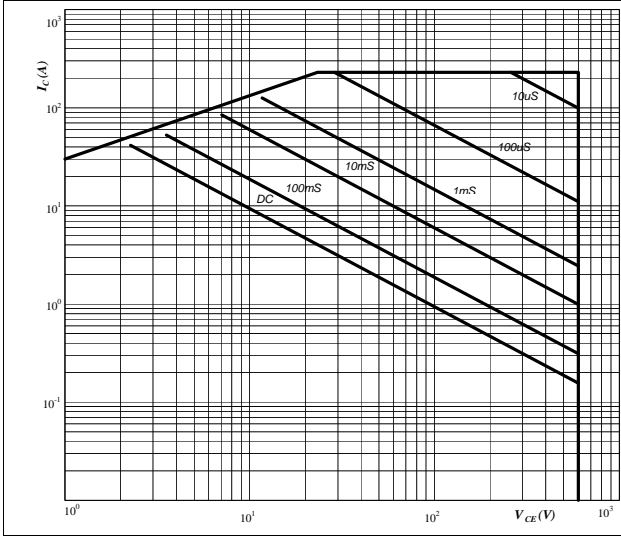
$$I_C = f(V_{CE})$$



At
 D = single pulse
 Th = 80 °C
 V_{GE} = 15 V
 T_j = T_{jmax} °C

Figure 26 MOSFET

Gate voltage vs Gate charge

$$V_{GE} = f(Q_g)$$

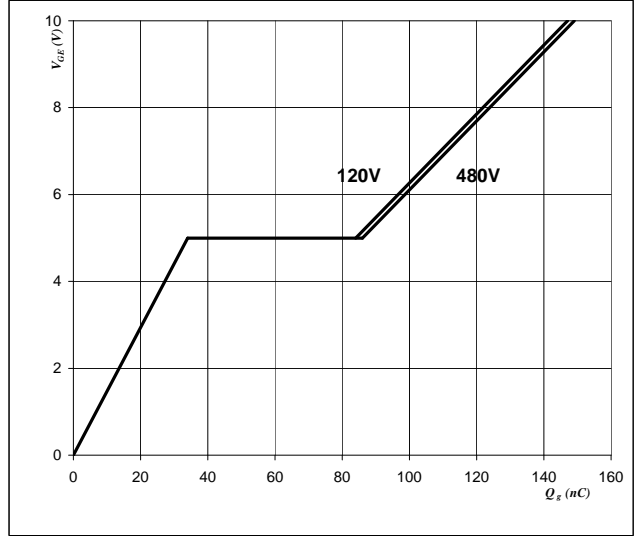

At
 I_C = 44 A

Boost

Figure 1 IGBT

Typical output characteristics

$I_C = f(V_{CE})$

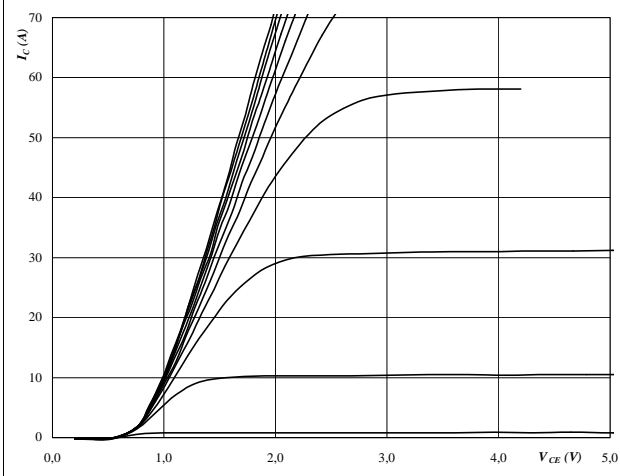

At
 $t_p = 250 \mu s$
 $T_j = 25 \text{ } ^\circ C$
 V_{GE} from 7 V to 17 V in steps of 1 V

Figure 2 IGBT

Typical output characteristics

$I_C = f(V_{CE})$

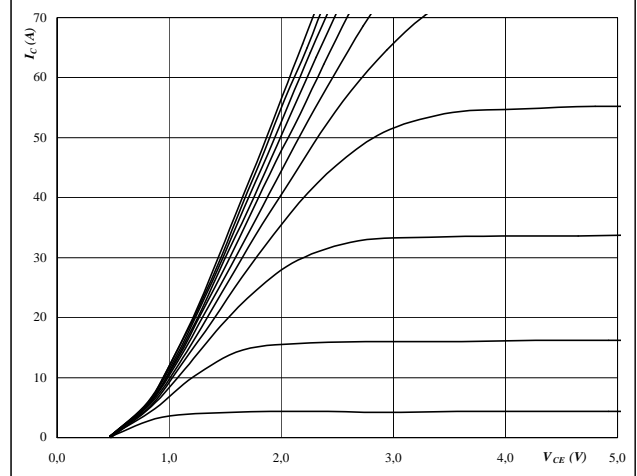

At
 $t_p = 250 \mu s$
 $T_j = 125 \text{ } ^\circ C$
 V_{GE} from 7 V to 17 V in steps of 1 V

Figure 3 IGBT

Typical transfer characteristics

$I_C = f(V_{GE})$

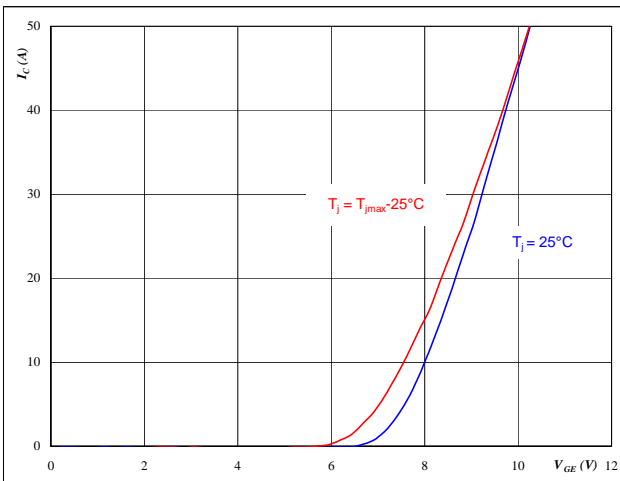

At
 $t_p = 250 \mu s$
 $V_{CE} = 10 V$

Figure 4 IGBT

IGBT transient thermal impedance as a function of pulse width

$Z_{thJH} = f(t_p)$

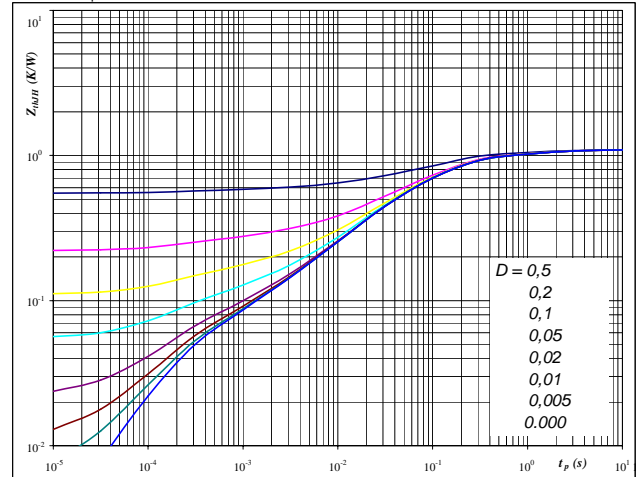

At

D =	t_p / T	IGBT thermal model values	
0,04		0,17	6,3E+00
0,17		0,58	1,0E-01
0,22		0,22	1,6E-02
0,05		0,05	1,7E-03

$R_{thJH} = 1,10 \text{ K/W}$

Boost

Figure 5 IGBT

Power dissipation as a function of heatsink temperature

$$P_{\text{tot}} = f(T_h)$$

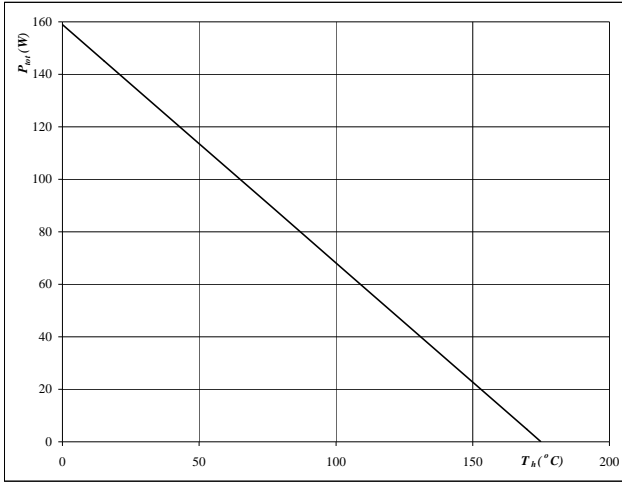
At
 $T_j = 175 \text{ } ^\circ\text{C}$
Figure 6 IGBT

Collector current as a function of heatsink temperature

$$I_C = f(T_h)$$

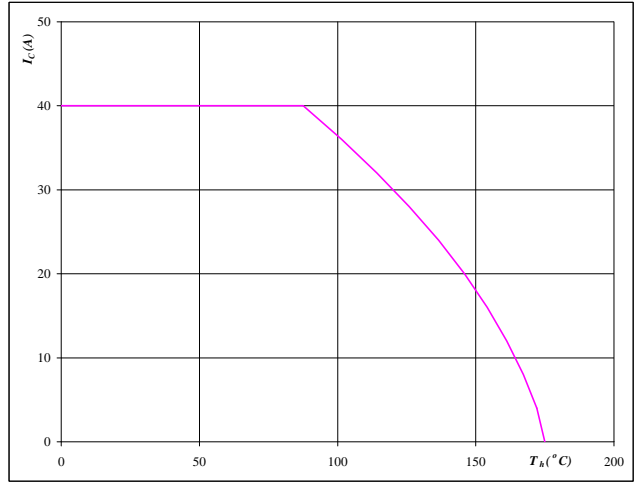

At
 $T_j = 175 \text{ } ^\circ\text{C}$
 $V_{\text{GE}} = 15 \text{ V}$

Boost

Figure 7 Boost Inverse Diode

Typical diode forward current as a function of forward voltage

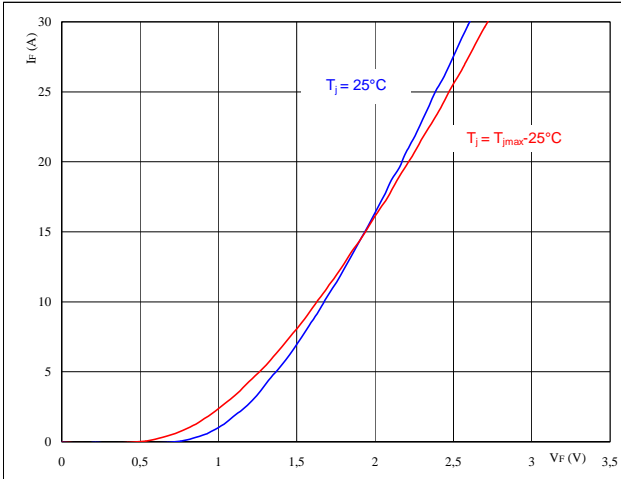
$$I_F = f(V_F)$$

At
 $t_p = 250 \mu s$
Figure 8 Boost Inverse Diode

Diode transient thermal impedance as a function of pulse width

$$Z_{thJH} = f(t_p)$$

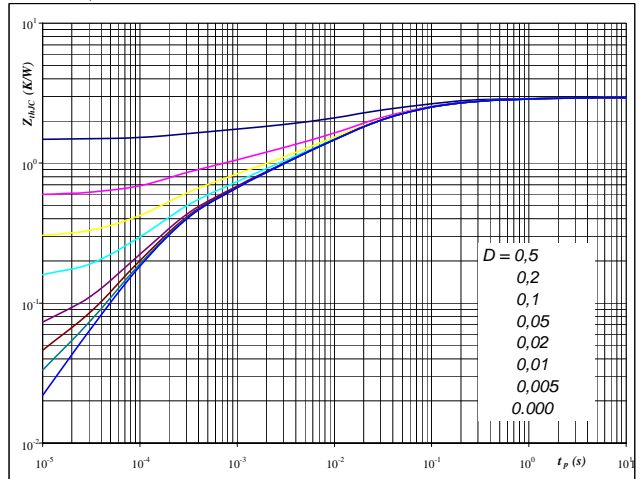
At
 $D = t_p / T$
 $R_{thJH} = 2,95 \text{ K/W}$
Figure 9 Boost Inverse Diode

Power dissipation as a function of heatsink temperature

$$P_{tot} = f(T_h)$$

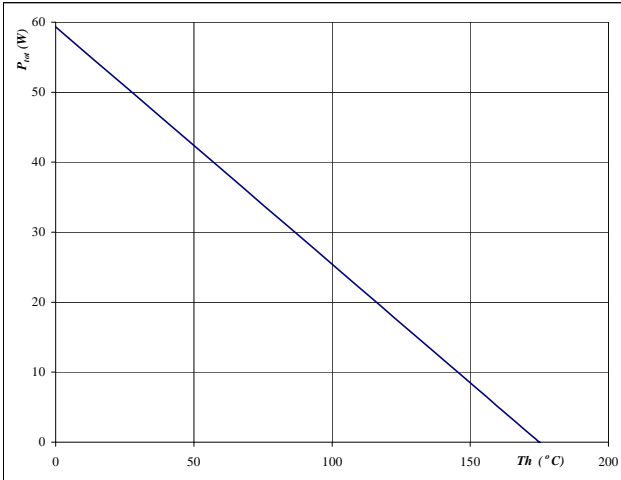
At
 $T_j = 175 \text{ °C}$
Figure 10 Boost Inverse Diode

Forward current as a function of heatsink temperature

$$I_F = f(T_h)$$

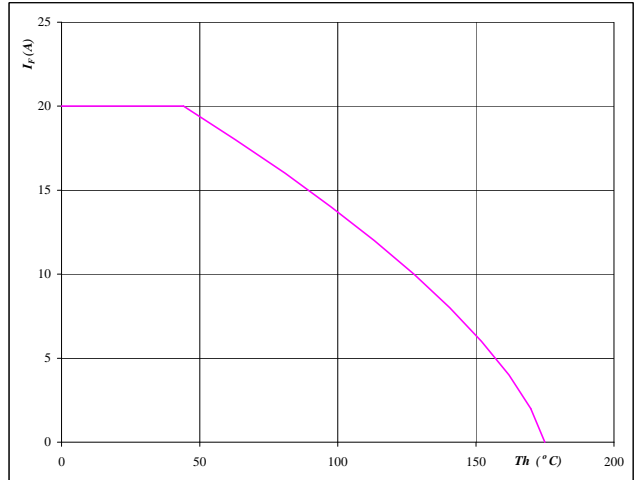
At
 $T_j = 175 \text{ °C}$

INPUT BOOST

Figure 1 BOOST MOSFET
Typical output characteristics

$I_D = f(V_{DS})$

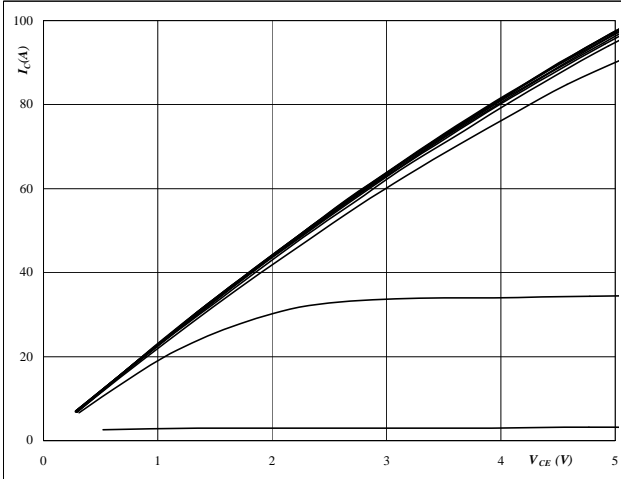

At
 $t_p = 250 \mu s$
 $T_j = 25 \text{ } ^\circ C$
 V_{GS} from 4 V to 14 V in steps of 1 V

Figure 2 BOOST MOSFET
Typical output characteristics

$I_D = f(V_{DS})$

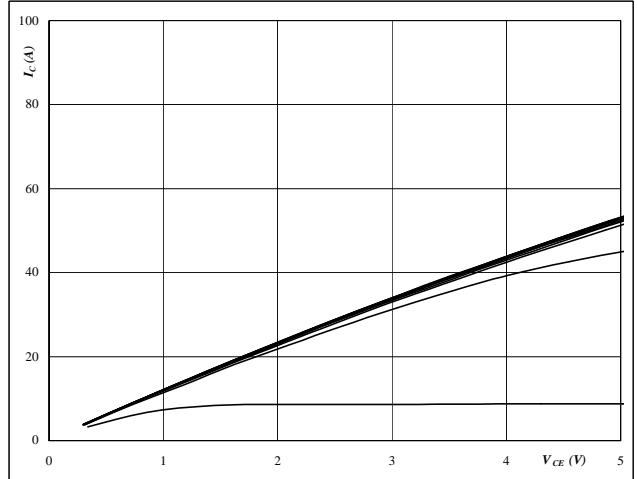

At
 $t_p = 250 \mu s$
 $T_j = 126 \text{ } ^\circ C$
 V_{GS} from 4 V to 14 V in steps of 1 V

Figure 3 BOOST MOSFET
Typical transfer characteristics

$I_D = f(V_{DS})$

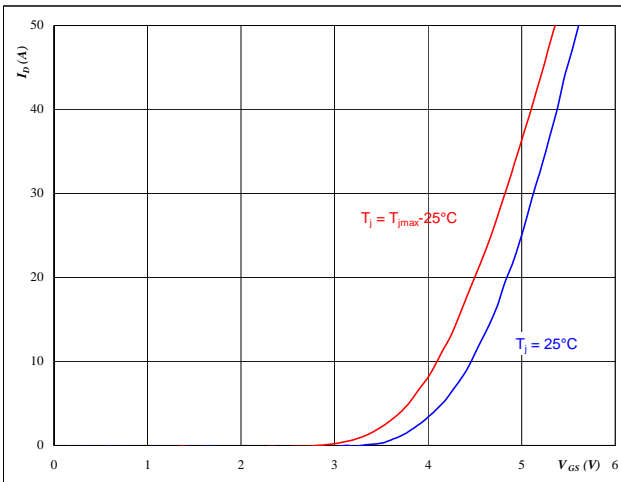

At
 $t_p = 250 \mu s$
 $V_{DS} = 10 V$

Figure 4 BOOST FRED
Typical diode forward current as a function of forward voltage

$I_F = f(V_F)$

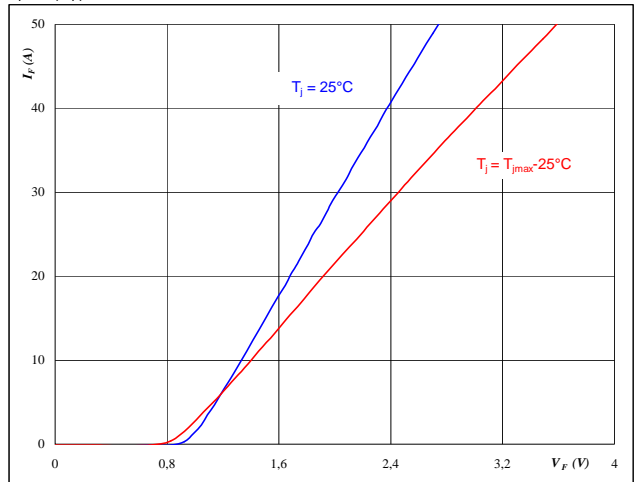

At
 $t_p = 250 \mu s$

INPUT BOOST

Figure 5 BOOST MOSFET

**Typical switching energy losses
as a function of collector current**

$$E = f(I_D)$$

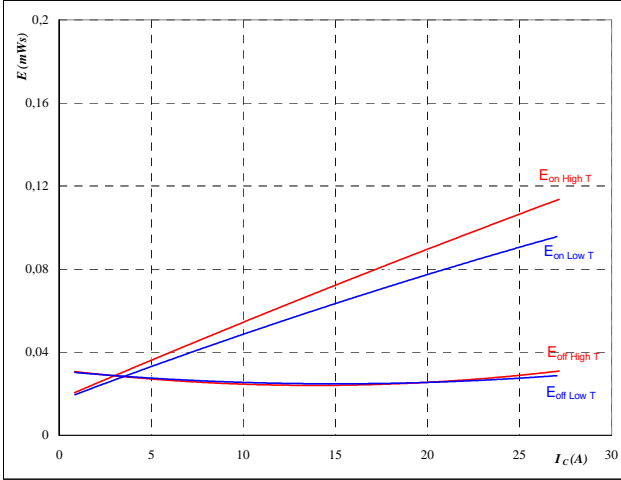

With an inductive load at

$T_J =$	25/125	°C
$V_{DS} =$	400	V
$V_{GS} =$	10	V
$R_{gon} =$	4	Ω
$R_{goff} =$	4	Ω

Figure 6 BOOST MOSFET

**Typical switching energy losses
as a function of gate resistor**

$$E = f(R_G)$$

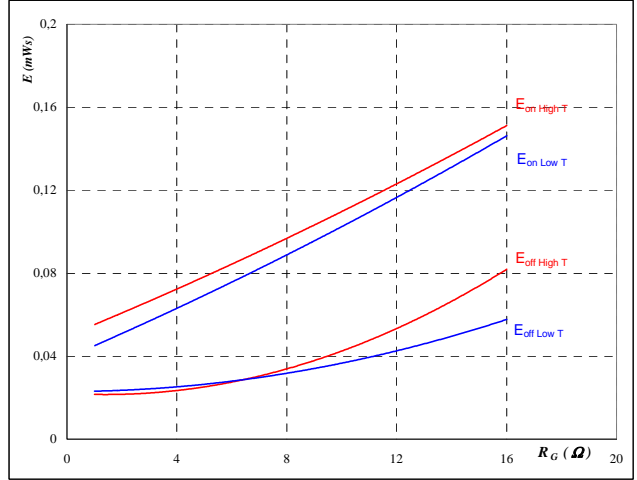

With an inductive load at

$T_J =$	25/125	°C
$V_{DS} =$	400	V
$V_{GS} =$	10	V
$I_D =$	15	A

Figure 7 BOOST FRED

**Typical reverse recovery energy loss
as a function of collector (drain) current**

$$E_{rec} = f(I_C)$$

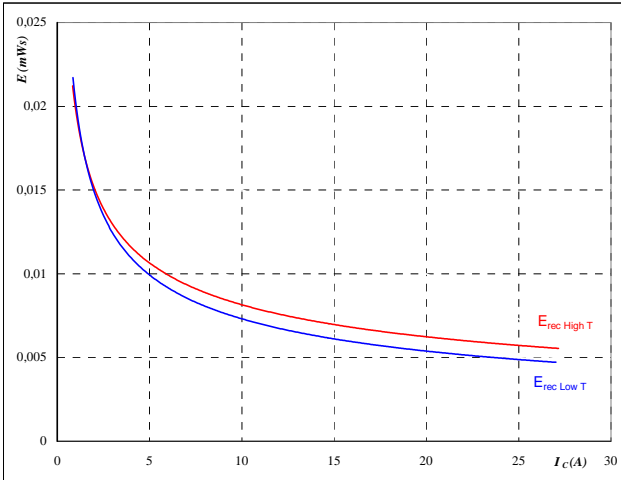

With an inductive load at

$T_J =$	25/125	°C
$V_{DS} =$	400	V
$V_{GS} =$	10	V
$R_{gon} =$	4	Ω
$R_{goff} =$	4	Ω

Figure 8 BOOST FRED

**Typical reverse recovery energy loss
as a function of gate resistor**

$$E_{rec} = f(R_G)$$

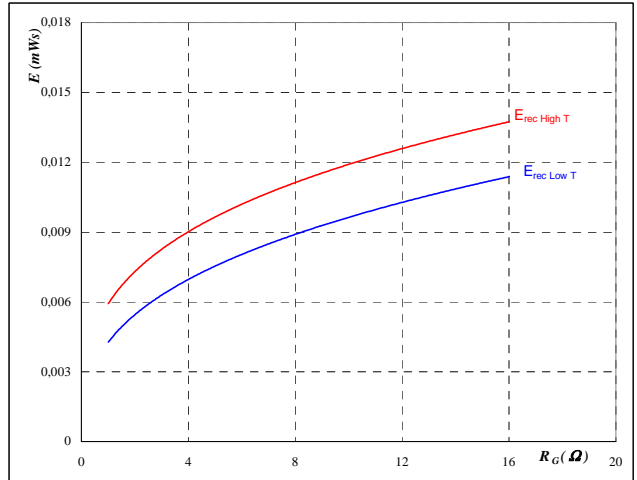

With an inductive load at

$T_J =$	25/125	°C
$V_{DS} =$	400	V
$V_{GS} =$	10	V
$I_D =$	15	A

INPUT BOOST

Figure 9 BOOST MOSFET

Typical switching times as a function of collector current
 $t = f(I_D)$

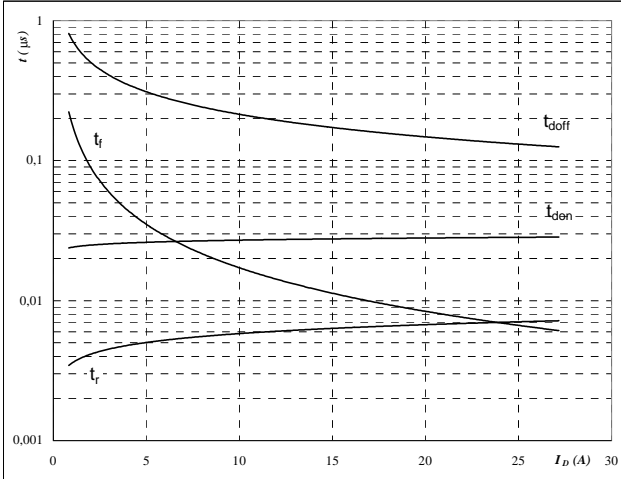

With an inductive load at

$T_j = 125 \text{ } ^\circ\text{C}$
 $V_{DS} = 400 \text{ V}$
 $V_{GS} = 10 \text{ V}$
 $R_{gon} = 4 \text{ } \Omega$
 $R_{goff} = 4 \text{ } \Omega$

Figure 10 BOOST MOSFET

Typical switching times as a function of gate resistor
 $t = f(R_G)$

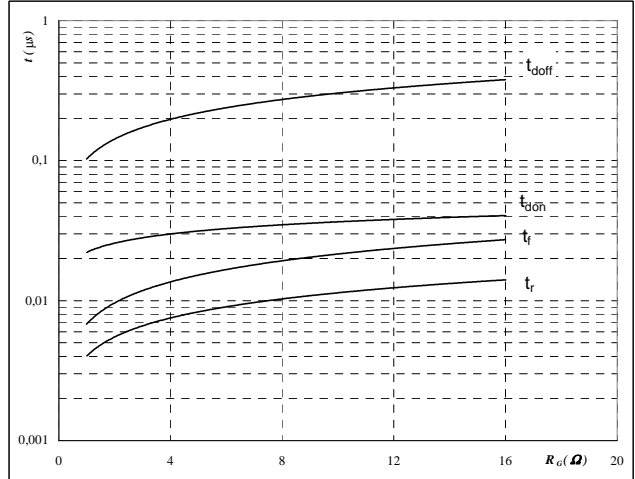

With an inductive load at

$T_j = 125 \text{ } ^\circ\text{C}$
 $V_{DS} = 400 \text{ V}$
 $V_{GS} = 10 \text{ V}$
 $I_C = 15 \text{ A}$

Figure 11 BOOST FRED

Typical reverse recovery time as a function of collector current
 $t_{rr} = f(I_C)$

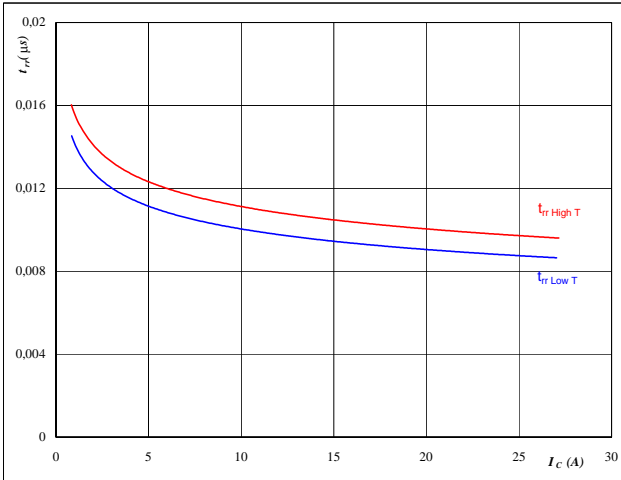

At

$T_j = 25/125 \text{ } ^\circ\text{C}$
 $V_{CE} = 400 \text{ V}$
 $V_{GE} = 10 \text{ V}$
 $R_{gon} = 4 \text{ } \Omega$

Figure 12 BOOST FRED

Typical reverse recovery time as a function of MOSFET turn on gate resistor
 $t_{rr} = f(R_{gon})$

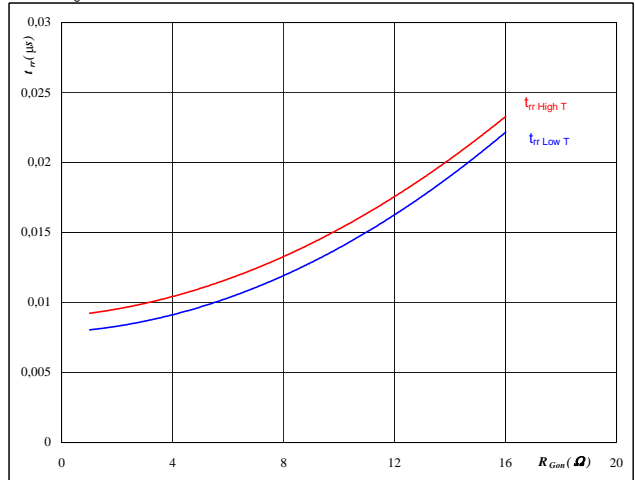

At

$T_j = 25/125 \text{ } ^\circ\text{C}$
 $V_R = 400 \text{ V}$
 $I_F = 15 \text{ A}$
 $V_{GS} = 10 \text{ V}$

INPUT BOOST

Figure 13 BOOST FRED

Typical reverse recovery charge as a function of collector current

$$Q_{rr} = f(I_c)$$

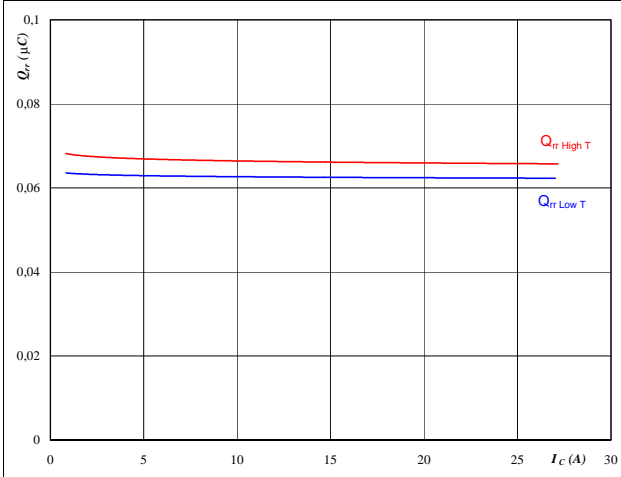

At

$T_j =$	25/125	°C
$V_{CE} =$	400	V
$V_{GE} =$	10	V
$R_{gon} =$	4	Ω

Figure 14 BOOST FRED

Typical reverse recovery charge as a function of MOSFET turn on gate resistor

$$Q_{rr} = f(R_{gon})$$

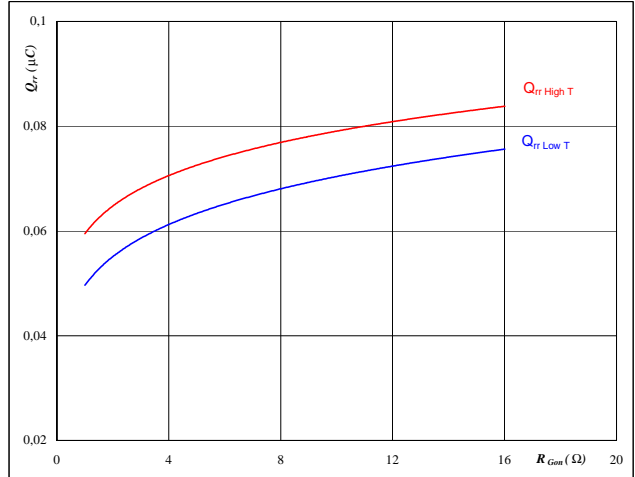

At

$T_j =$	25/125	°C
$V_R =$	400	V
$I_F =$	15	A
$V_{GS} =$	10	V

Figure 15 BOOST FRED

Typical reverse recovery current as a function of collector current

$$I_{RRM} = f(I_c)$$

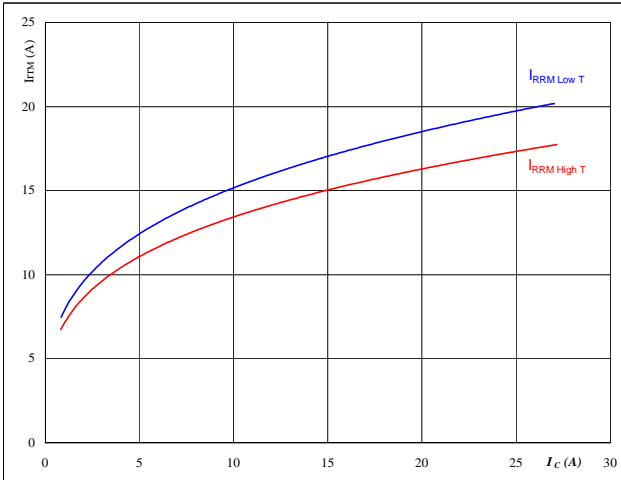

At

$T_j =$	25/125	°C
$V_{CE} =$	400	V
$V_{GE} =$	10	V
$R_{gon} =$	4	Ω

Figure 16 BOOST FRED

Typical reverse recovery current as a function of MOSFET turn on gate resistor

$$I_{RRM} = f(R_{gon})$$

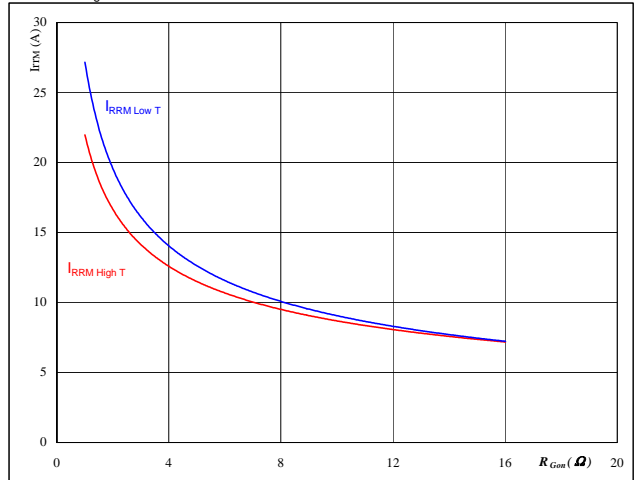

At

$T_j =$	25/125	°C
$V_R =$	400	V
$I_F =$	15	A
$V_{GS} =$	10	V

INPUT BOOST

Figure 17 BOOST FRED

Typical rate of fall of forward and reverse recovery current as a function of collector current

$$dI_f/dt, dI_{rec}/dt = f(I_c)$$

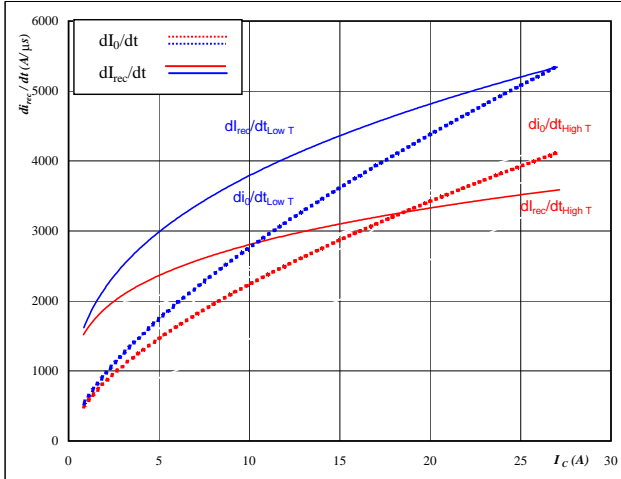

At
 $T_j = 25/125 \text{ } ^\circ\text{C}$
 $V_{CE} = 400 \text{ V}$
 $V_{GE} = 10 \text{ V}$
 $R_{gon} = 4 \text{ } \Omega$

Figure 18 BOOST FRED

Typical rate of fall of forward and reverse recovery current as a function of MOSFET turn on gate resistor

$$dI_f/dt, dI_{rec}/dt = f(R_{gon})$$

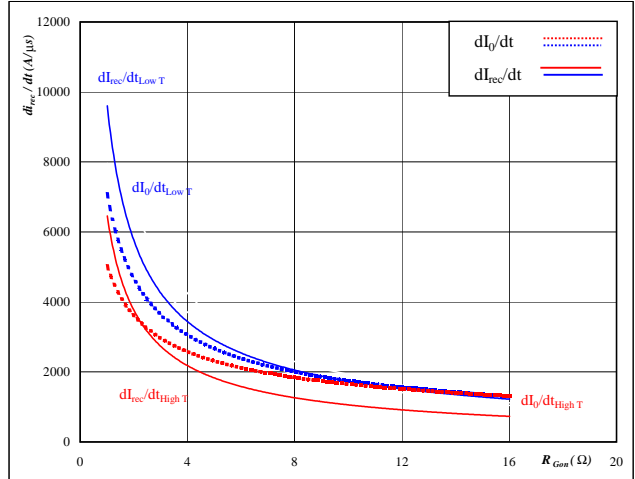

At
 $T_j = 25/125 \text{ } ^\circ\text{C}$
 $V_R = 400 \text{ V}$
 $I_F = 15 \text{ A}$
 $V_{GS} = 10 \text{ V}$

Figure 19 BOOST MOSFET

IGBT/MOSFET transient thermal impedance as a function of pulse width

$$Z_{thJH} = f(t_p)$$

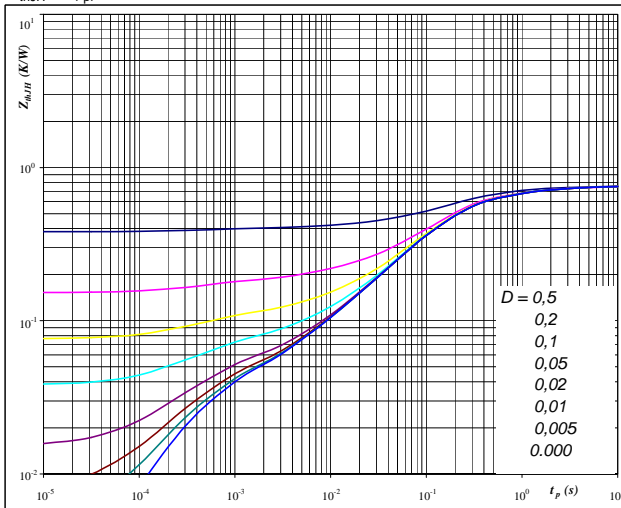

At
 $D = t_p / T$
 $R_{thJH} = 0,76 \text{ K/W}$

IGBT thermal model values

R (C/W)	Tau (s)
3,25E-02	9,97E+00
1,22E-01	1,22E+00
4,26E-01	1,80E-01
1,17E-01	4,70E-02
3,10E-02	5,89E-03
3,30E-02	4,04E-04

Figure 20 BOOST FRED

FRED transient thermal impedance as a function of pulse width

$$Z_{thJH} = f(t_p)$$

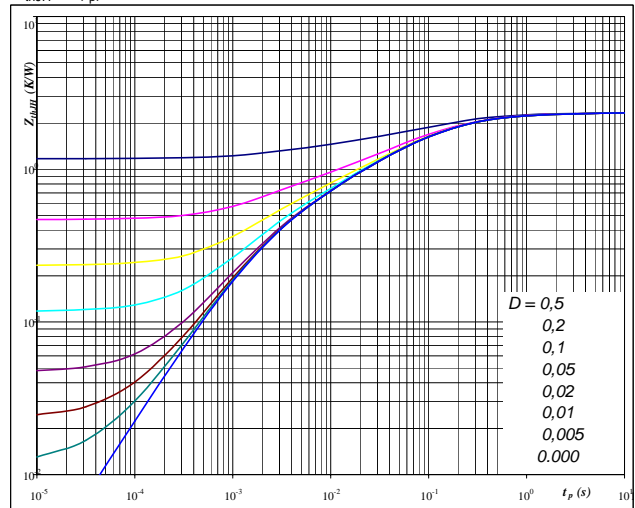

At
 $D = t_p / T$
 $R_{thJH} = 2,34 \text{ K/W}$

FRED thermal model values

R (C/W)	Tau (s)
1,02E-01	2,89E+00
4,95E-01	3,44E-01
9,89E-01	7,04E-02
4,87E-01	1,00E-02
2,67E-01	1,61E-03

INPUT BOOST

Figure 21 BOOST MOSFET
Power dissipation as a function of heatsink temperature

$$P_{tot} = f(T_h)$$



At
 $T_j = 150$ °C

Figure 22 BOOST MOSFET
Collector/Drain current as a function of heatsink temperature

$$I_C = f(T_h)$$

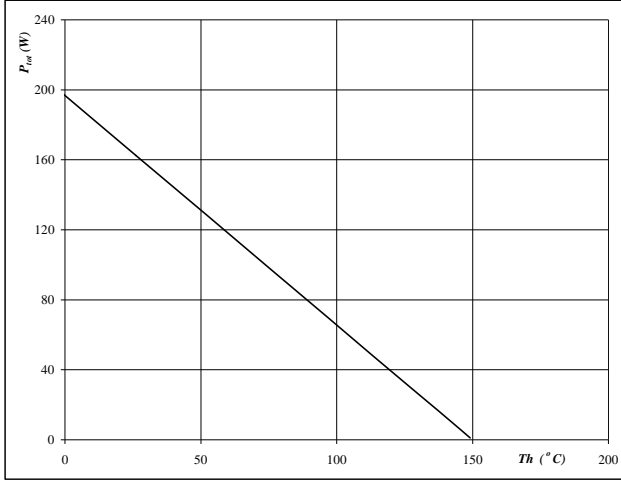

At
 $T_j = 150$ °C
 $V_{GS} = 10$ V

Figure 23 BOOST FRED
Power dissipation as a function of heatsink temperature

$$P_{tot} = f(T_h)$$

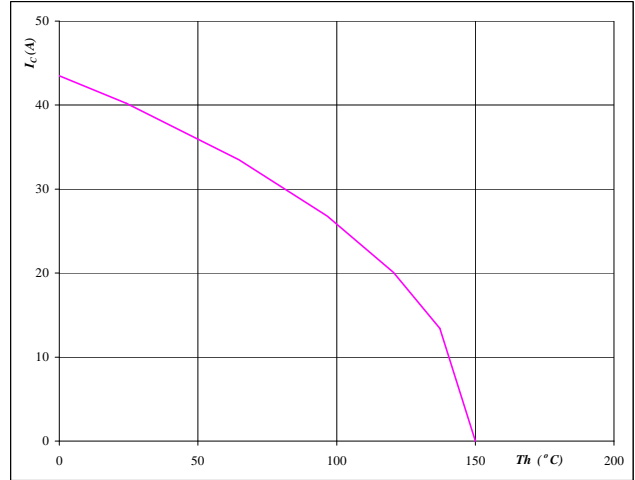

At
 $T_j = 175$ °C

Figure 24 BOOST FRED
Forward current as a function of heatsink temperature

$$I_F = f(T_h)$$

At
 $T_j = 175$ °C

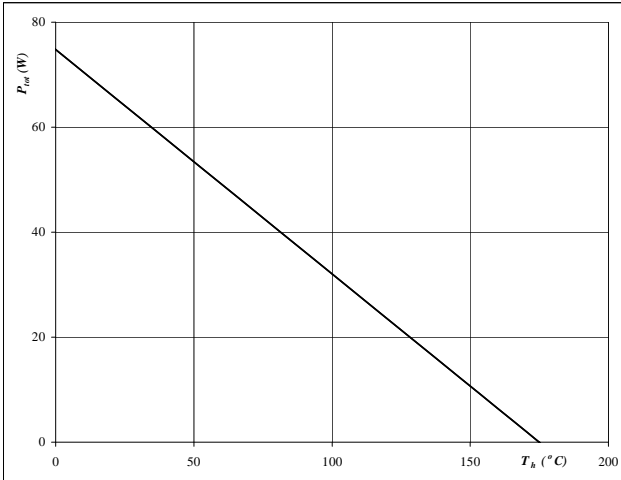
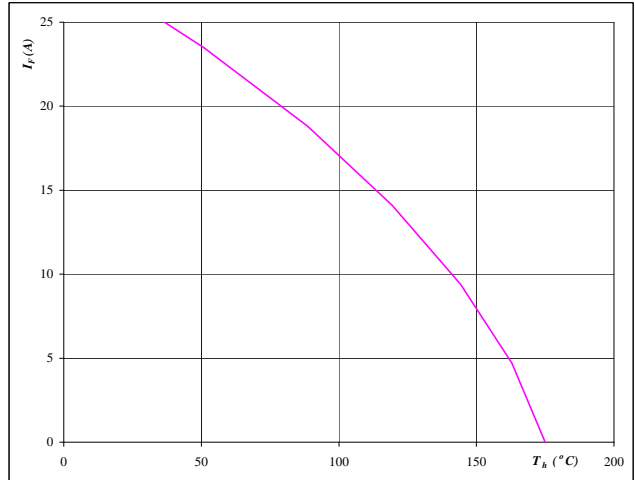
INPUT BOOST

Figure 25 BOOST MOSFET
Safe operating area as a function of drain-source voltage

$$I_D = f(V_{DS})$$

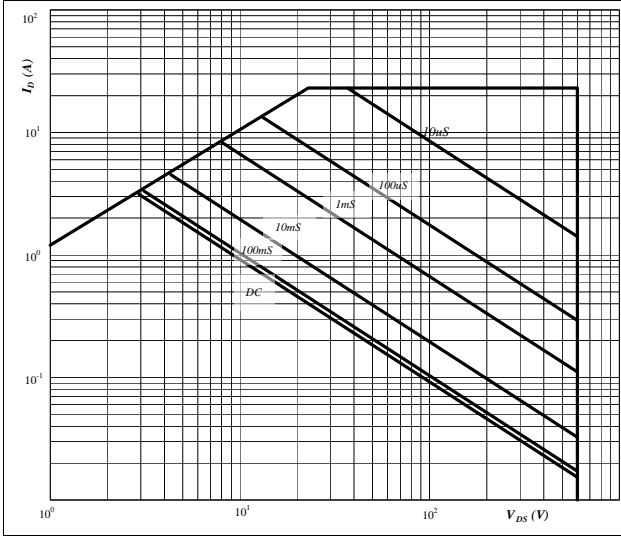

At
 D = single pulse
 $T_n = 80 \text{ } ^\circ\text{C}$
 $V_{GS} = 10 \text{ V}$
 $T_j = T_{jmax} \text{ } ^\circ\text{C}$

Figure 26 BOOST MOSFET
Gate voltage vs Gate charge

$$V_{GS} = f(Q_g)$$

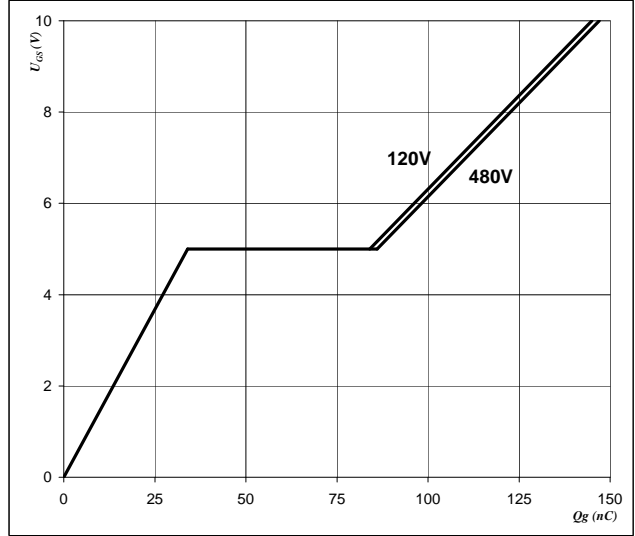

At
 $I_D = 44 \text{ A}$

Bypass Diode

Figure 1 Bypass diode

Typical diode forward current as a function of forward voltage

$$I_F = f(V_F)$$

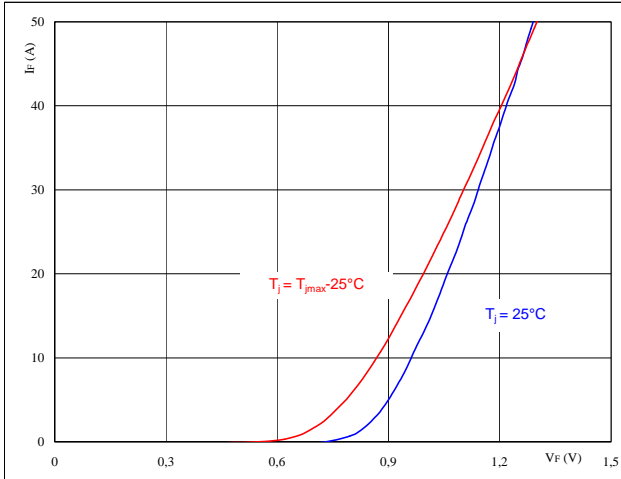
At
 $t_p = 250 \mu s$
Figure 2 Bypass diode

Diode transient thermal impedance as a function of pulse width

$$Z_{thJC} = f(t_p)$$

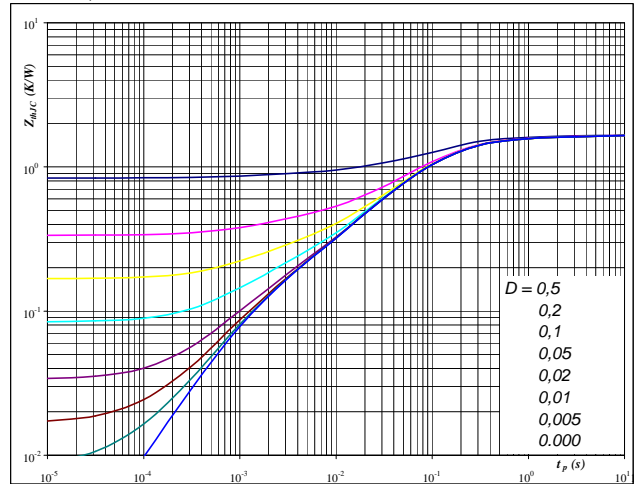
At
 $D = t_p / T$
 $R_{thJH} = 1,677 \text{ K/W}$
Figure 3 Bypass diode

Power dissipation as a function of heatsink temperature

$$P_{tot} = f(T_h)$$

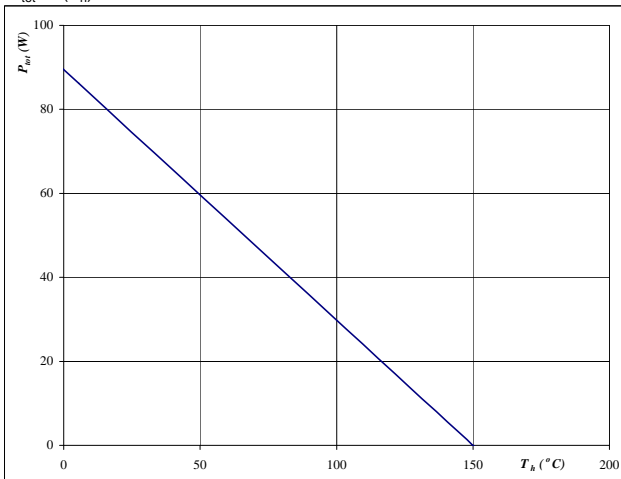
At
 $T_j = 150 \text{ }^\circ\text{C}$
Figure 4 Bypass diode

Forward current as a function of heatsink temperature

$$I_F = f(T_h)$$

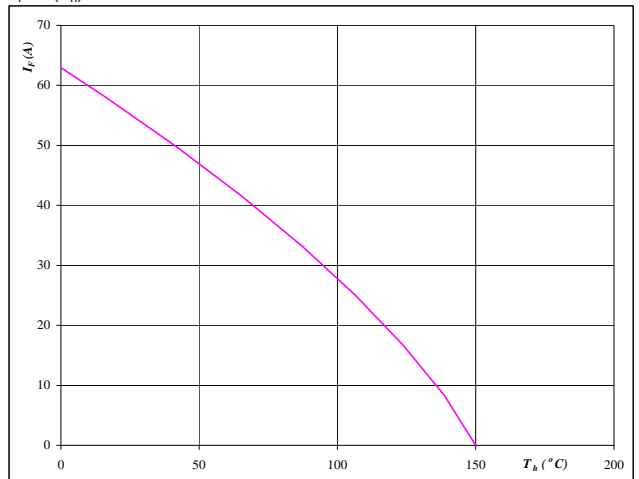
At
 $T_j = 150 \text{ }^\circ\text{C}$

Thermistor

Figure 1 Thermistor

Typical NTC characteristic
 as a function of temperature

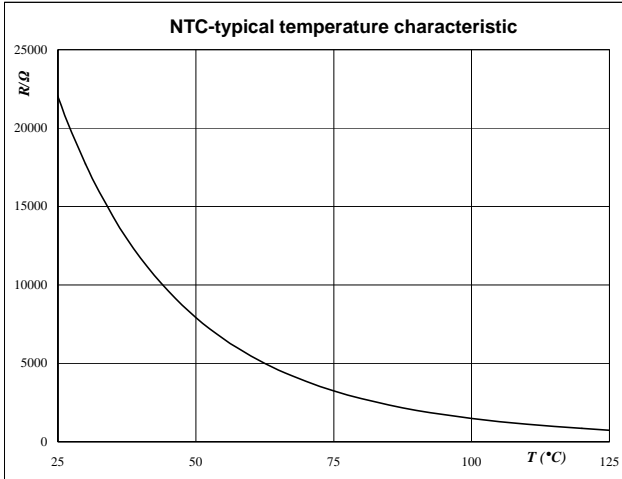
 $R_T = f(T)$

Figure 2 Thermistor

Typical NTC resistance values

$$R(T) = R_{25} \cdot e^{\left(B_{25/100} \left(\frac{1}{T} - \frac{1}{T_{25}} \right) \right)} \quad [\Omega]$$

T [°C]	R _{nom} [Ω]	R _{min} [Ω]	R _{max} [Ω]	ΔR/R [±%]
-55	2089434,5	1506495,4	2672373,6	27,9
0	71804,2	59724,4	83884	16,8
10	43780,4	37094,4	50466,5	15,3
20	27484,6	23684,6	31284,7	13,8
25	22000	19109,3	24890,7	13,1
30	17723,3	15512,2	19934,4	12,5
60	5467,9	4980,6	5955,1	8,9
70	3848,6	3546	4151,1	7,9
80	2757,7	2568,2	2947,1	6,9
90	2008,9	1889,7	2128,2	5,9
100	1486,1	1411,8	1560,4	5
150	400,2	364,8	435,7	8,8

Switching Definitions BUCK MOSFET

General conditions

T_j	=	125 °C
R_{gon}	=	4 Ω
R_{goff}	=	4 Ω

Figure 1 Output inverter IGBT

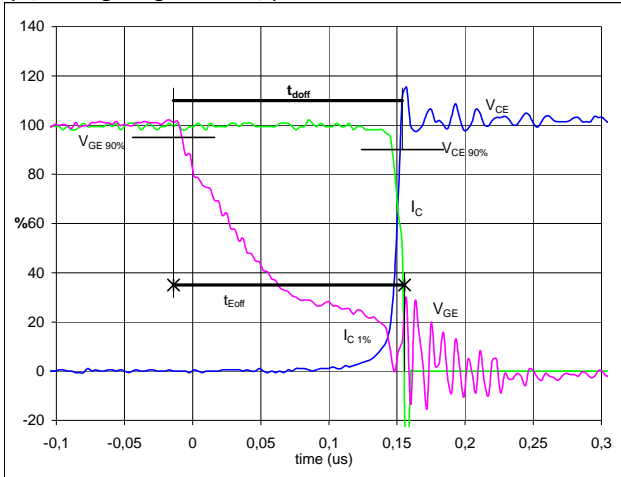
Turn-off Switching Waveforms & definition of t_{doff} , t_{Eoff}
 (t_{Eoff} = integrating time for E_{off})

V_{GE} (0%) =	0	V
V_{GE} (100%) =	10	V
V_C (100%) =	400	V
I_C (100%) =	15	A
t_{doff} =	0,16	μ s
t_{Eoff} =	0,17	μ s

Figure 2 Output inverter IGBT

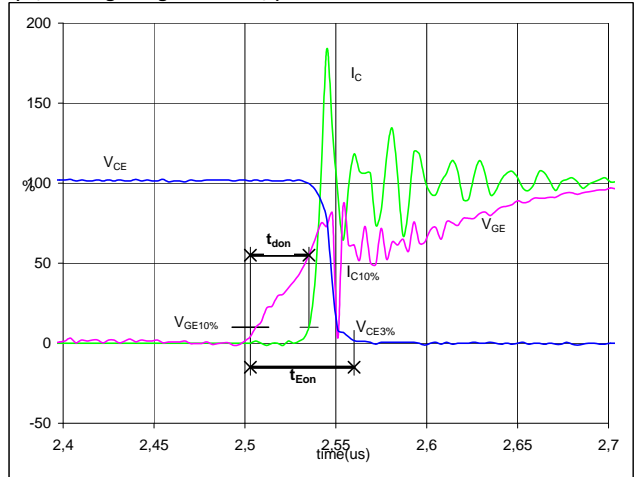
Turn-on Switching Waveforms & definition of t_{don} , t_{Eon}
 (t_{Eon} = integrating time for E_{on})

V_{GE} (0%) =	0	V
V_{GE} (100%) =	10	V
V_C (100%) =	400	V
I_C (100%) =	15	A
t_{don} =	0,03	μ s
t_{Eon} =	0,06	μ s

Figure 3 Output inverter IGBT

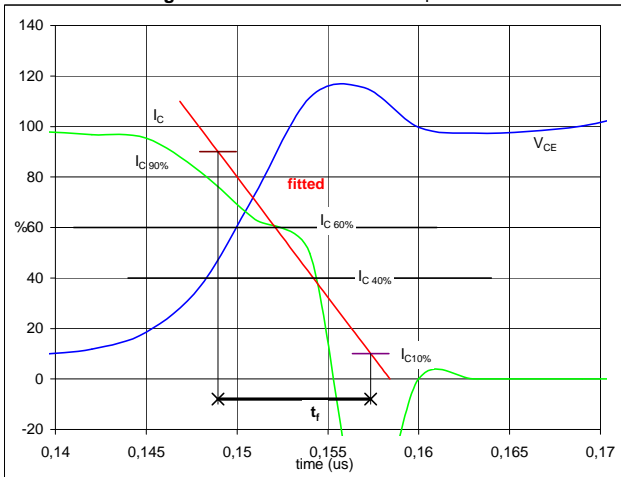
Turn-off Switching Waveforms & definition of t_f

V_C (100%) =	400	V
I_C (100%) =	15	A
t_f =	0,01	μ s

Figure 4 Output inverter IGBT

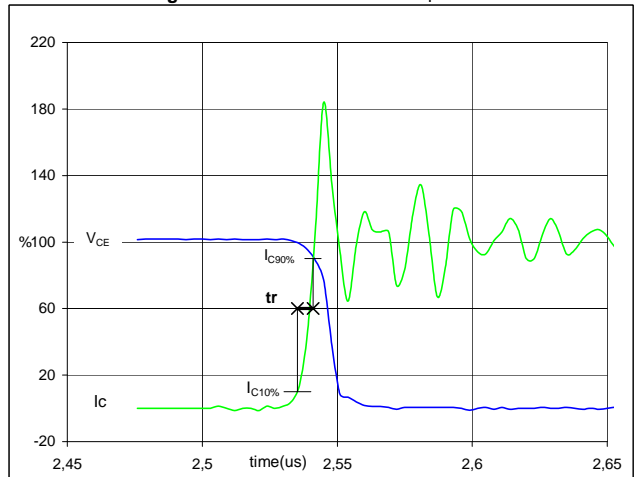
Turn-on Switching Waveforms & definition of t_r

V_C (100%) =	400	V
I_C (100%) =	15	A
t_r =	0,01	μ s

Switching Definitions BUCK MOSFET

Figure 5 Output inverter IGBT

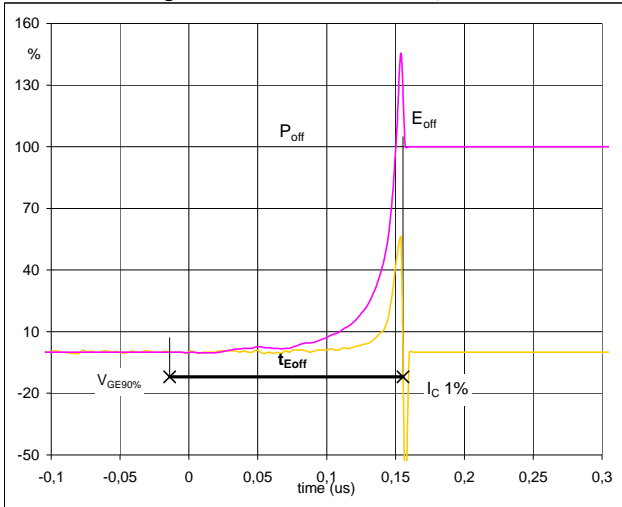
Turn-off Switching Waveforms & definition of t_{Eoff}

$P_{off} (100\%) = 6,01 \text{ kW}$
 $E_{off} (100\%) = 0,02 \text{ mJ}$
 $t_{Eoff} = 0,17 \text{ } \mu\text{s}$

Figure 6 Output inverter IGBT

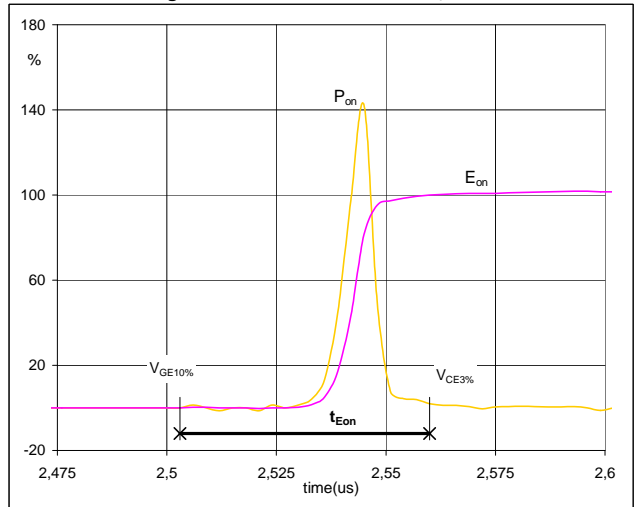
Turn-on Switching Waveforms & definition of t_{Eon}

$P_{on} (100\%) = 6,01 \text{ kW}$
 $E_{on} (100\%) = 0,07 \text{ mJ}$
 $t_{Eon} = 0,06 \text{ } \mu\text{s}$

Figure 7 Output inverter FRED

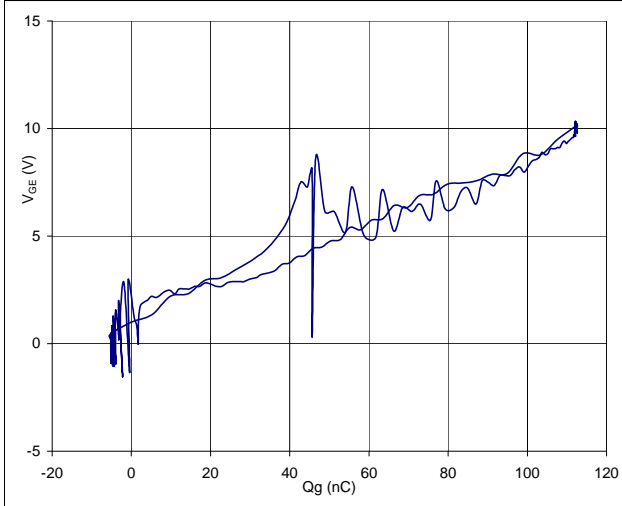
Gate voltage vs Gate charge (measured)

$V_{GEoff} = 0 \text{ V}$
 $V_{GEon} = 10 \text{ V}$
 $V_C (100\%) = 400 \text{ V}$
 $I_C (100\%) = 15 \text{ A}$
 $Q_g = 112,54 \text{ nC}$

Figure 8 Output inverter IGBT

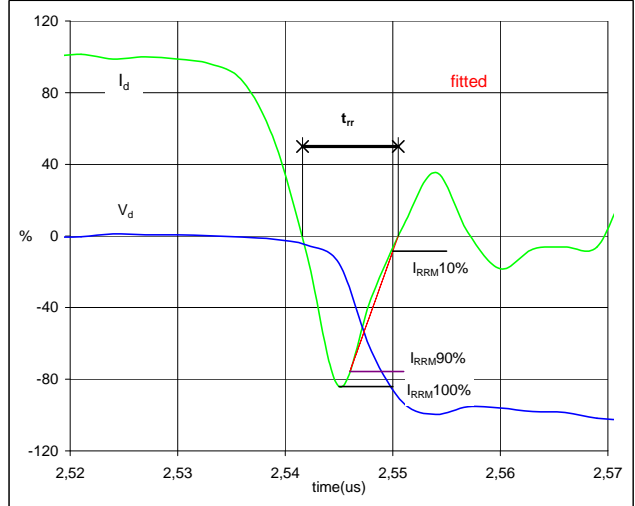
Turn-off Switching Waveforms & definition of t_{rr}

$V_d (100\%) = 400 \text{ V}$
 $I_d (100\%) = 15 \text{ A}$
 $I_{RRM} (100\%) = -6 \text{ A}$
 $t_{rr} = 0,01 \text{ } \mu\text{s}$

Switching Definitions BUCK MOSFET

Figure 9 Output inverter FRED

Turn-on Switching Waveforms & definition of t_{Qrr}
(t_{Qrr} = integrating time for Q_{rr})

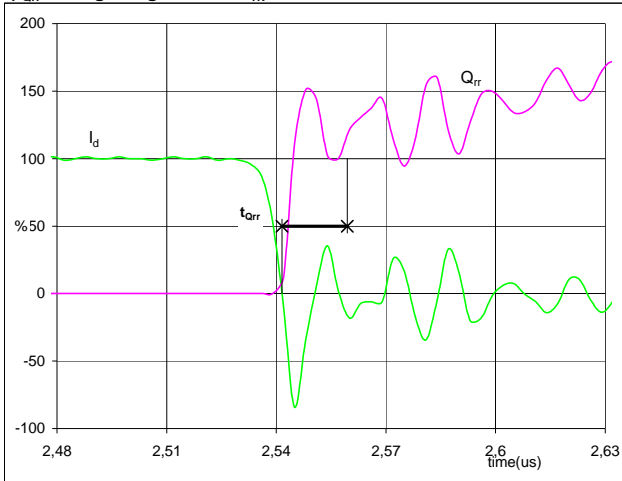

I_d (100%) = 15 A
 Q_{rr} (100%) = 0,03 μ C
 t_{Qrr} = 0,02 μ s

Figure 10 Output inverter FRED

Turn-on Switching Waveforms & definition of t_{Erec}
(t_{Erec} = integrating time for E_{rec})

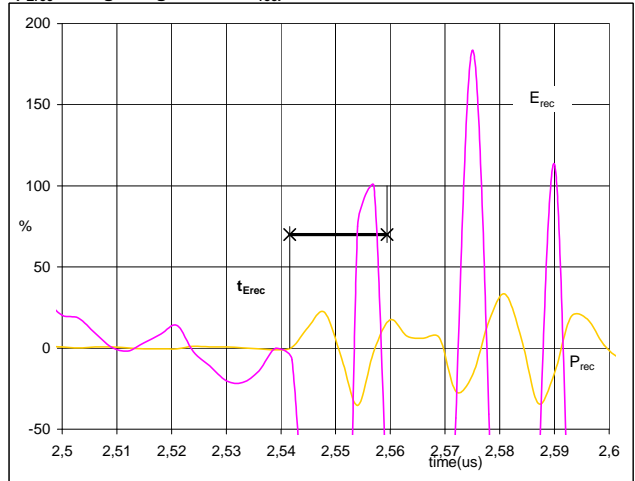

P_{rec} (100%) = 6,01 kW
 E_{rec} (100%) = 0,01 mJ
 t_{Erec} = 0,02 μ s

Measurement circuits

Figure 11

BUCK stage switching measurement circuit

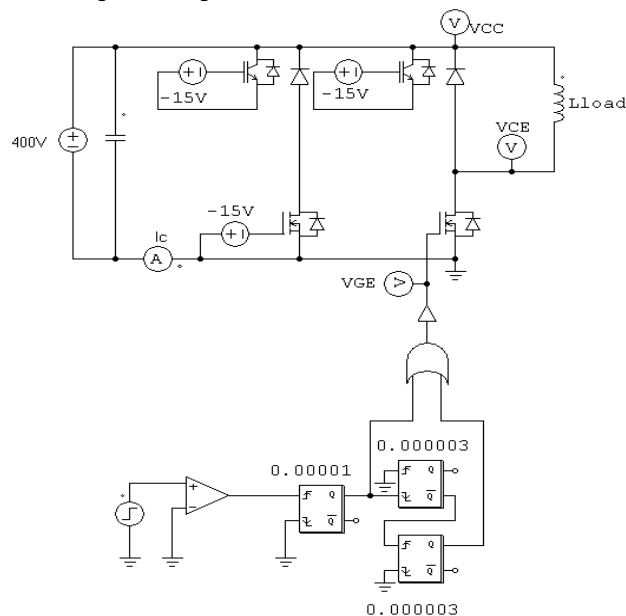

Ordering Code and Marking - Outline - Pinout
Ordering Code & Marking

Version	Ordering Code	in DataMatrix as	in packaging barcode as
without thermal paste 12mm housing	10-FZ06BIA045FH02-P897D	P897D	P897D

Outline

Pin table		
Pin	X	Y
1	28,7	0
2	25,9	0
3	23,1	0
4	17,6	0
5	12,1	0
6	9,3	0
7	2,8	0
8	0	0
9	0	5,05
10	0	10,55
11	0	16,15
12	0	22,6
13	9,3	22,6
14	12,1	22,6
15	17,6	22,6
16	23,1	22,6
17	25,9	22,6
18	28,7	22,6
19	33,6	20,05
20	33,6	14,55
21	33,6	8,05
22	33,6	2,55

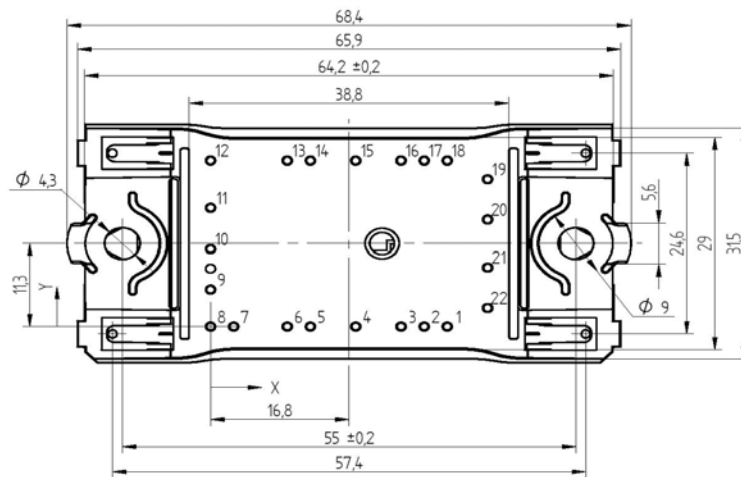
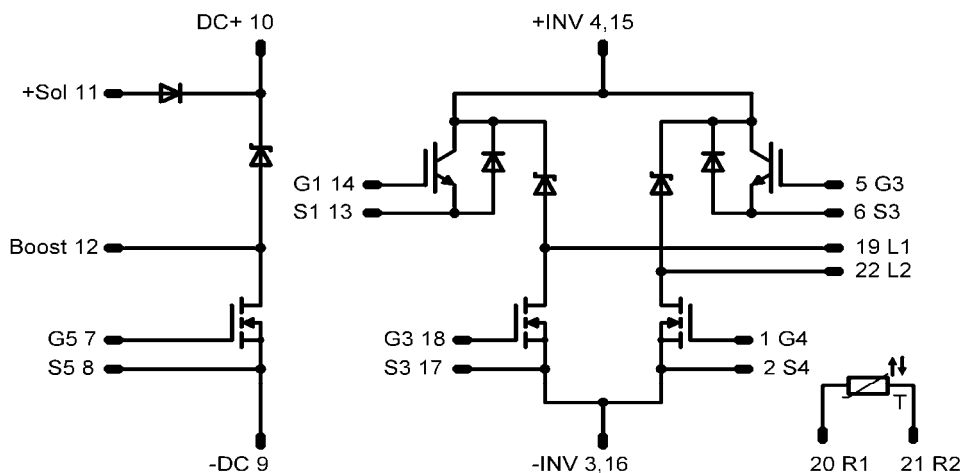
Pinout

PRODUCT STATUS DEFINITIONS

Datasheet Status	Product Status	Definition
Target	Formative or In Design	This datasheet contains the design specifications for product development. Specifications may change in any manner without notice. The data contained is exclusively intended for technically trained staff.
Preliminary	First Production	This datasheet contains preliminary data, and supplementary data may be published at a later date. Vincotech reserves the right to make changes at any time without notice in order to improve design. The data contained is exclusively intended for technically trained staff.
Final	Full Production	This datasheet contains final specifications. Vincotech reserves the right to make changes at any time without notice in order to improve design. The data contained is exclusively intended for technically trained staff.

DISCLAIMER

The information given in this datasheet describes the type of component and does not represent assured characteristics. For tested values please contact Vincotech. Vincotech reserves the right to make changes without further notice to any products herein to improve reliability, function or design. Vincotech does not assume any liability arising out of the application or use of any product or circuit described herein; neither does it convey any license under its patent rights, nor the rights of others.

LIFE SUPPORT POLICY

Vincotech products are not authorised for use as critical components in life support devices or systems without the express written approval of Vincotech.

As used herein:

1. Life support devices or systems are devices or systems which, (a) are intended for surgical implant into the body, or (b) support or sustain life, or (c) whose failure to perform when properly used in accordance with instructions for use provided in labelling can be reasonably expected to result in significant injury to the user.
2. A critical component is any component of a life support device or system whose failure to perform can be reasonably expected to cause the failure of the life support device or system, or to affect its safety or effectiveness.