

DESCRIPTION

The SSF2300 uses advanced trench technology to provide excellent $R_{DS(ON)}$, low gate charge and operation with gate voltages as low as 2.5V. This device is suitable for use as a Battery protection or in other Switching application.

GENERAL FEATURES

- $V_{DS} = 20V, I_D = 2.4A$
 $R_{DS(ON)} < 110m\Omega @ V_{GS}=2.5V$
 $R_{DS(ON)} < 55m\Omega @ V_{GS}=4.5V$
- High Power and current handing capability
- Lead free product is acquired
- Surface Mount Package

Application

- Battery protection
- Load switch
- Power management

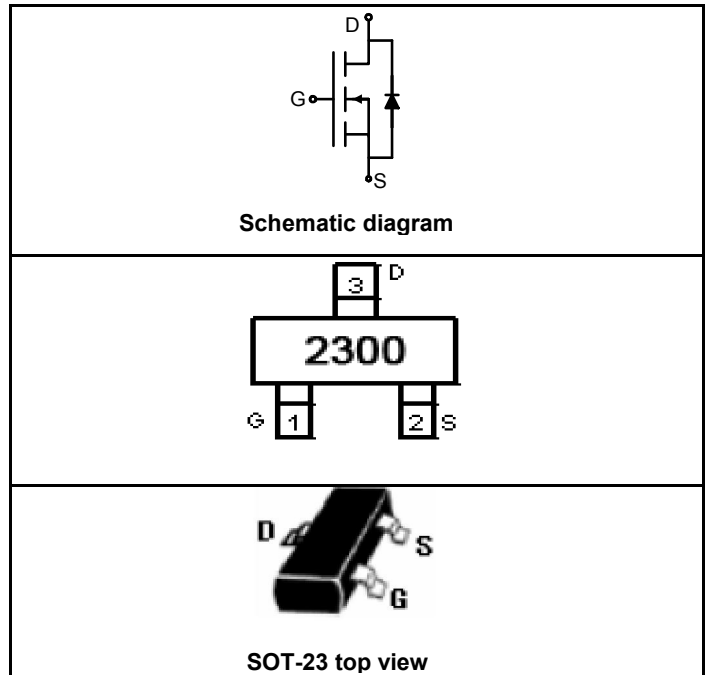

PACKAGE MARKING AND ORDERING INFORMATION

Marking and pin Assignment

Device Marking	Device	Device Package	Reel Size	Tape width	Quantity
2300	SSF2300	SOT-23	Ø180mm	8 mm	3000 units

ABSOLUTE MAXIMUM RATINGS(TA=25°C unless otherwise noted)

Parameter	Symbol	Limit	Unit
Drain-Source Voltage	V_{DS}	20	V
Gate-Source Voltage	V_{GS}	±8	V
Drain Current-Continuous@ Current-Pulsed (Note 1)	$I_D (25^\circ C)$	2.4	A
	$I_D (70^\circ C)$	1.	A
	I_{DM}	10	A
Maximum Power Dissipation	P_D	0.9	W
Operating Junction and Storage Temperature Range	T_J, T_{STG}	-55 To 150	°C

THERMAL CHARACTERISTICS

Thermal Resistance,Junction-to-Ambient (Note 2)	$R_{\theta JA}$	140	°C/W
---	-----------------	-----	------

ELECTRICAL CHARACTERISTICS (TA=25°C unless otherwise noted)

Parameter	Symbol	Condition	Min	Typ	Max	Unit
OFF CHARACTERISTICS						
Drain-Source Breakdown Voltage	BV_{DSS}	$V_{GS}=0V, I_D=250\mu A$	20			V
Zero Gate Voltage Drain Current	I_{DSS}	$V_{DS}=20V, V_{GS}=0V$			1	μA
Gate-Body Leakage Current	I_{GSS}	$V_{GS}=\pm 8V, V_{DS}=0V$			±100	nA
ON CHARACTERISTICS (Note 3)						
Gate Threshold Voltage	$V_{GS(th)}$	$V_{DS}=V_{GS}, I_D=250\mu A$	0.65	0.95	1.2	V



GDSSF2300

Drain-Source On-State Resistance	$R_{DS(ON)}$	$V_{GS}=2.5V, I_D=3.1A$	68	110	m Ω
		$V_{GS}=4.5V, I_D=3.6A$	42	55	m Ω
Forward Transconductance	g_{FS}	$V_{DS}=5V, I_D=3.6A$	8		S
DYNAMIC CHARACTERISTICS (Note4)					
Input Capacitance	C_{ISS}	$V_{DS}=10V, V_{GS}=0V,$ $F=1.0MHz$	300		PF
Output Capacitance	C_{OSS}		120		PF
Reverse Transfer Capacitance	C_{RSS}		80		PF
SWITCHING CHARACTERISTICS (Note 4)					
Turn-on Delay Time	$t_{d(on)}$	$V_{DD}=10V, R_L = 2.8 \Omega$ $V_{GS}=4.5V, R_{GEN}=6\Omega,$ $I_D=3.6A,$	7	15	nS
Turn-on Rise Time	t_r		55	80	nS
Turn-Off Delay Time	$t_{d(off)}$		16	60	nS
Turn-Off Fall Time	t_f		10	25	nS
Total Gate Charge	Q_g	$V_{DS}=10V, I_D=3.6A, V_{GS}=4.5V$	4.0	10	nC
Gate-Source Charge	Q_{gs}		0.65		nC
Gate-Drain Charge	Q_{gd}		1.5		nC
DRAIN-SOURCE DIODE CHARACTERISTICS					
Diode Forward Voltage (Note 3)	V_{SD}	$V_{GS}=0V, I_S=0.94A$	0.76	1.2	V
Diode Forward Current (Note 2)	I_S		0.94		A

NOTES:

1. Repetitive Rating: Pulse width limited by maximum junction temperature.
2. Surface Mounted on 1in² FR4 Board, $t \leq 10$ sec.
3. Pulse Test: Pulse Width $\leq 300\mu s$, Duty Cycle $\leq 2\%$.
4. Guaranteed by design, not subject to production testing.

TYPICAL ELECTRICAL AND THERMAL CHARACTERISTICS

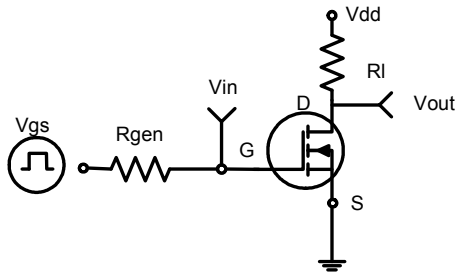

Figure 1: Switching Test Circuit

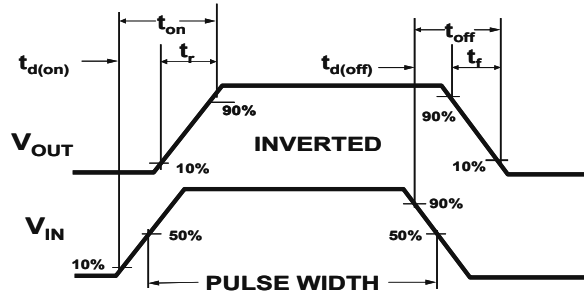

Figure 2: Switching Waveforms

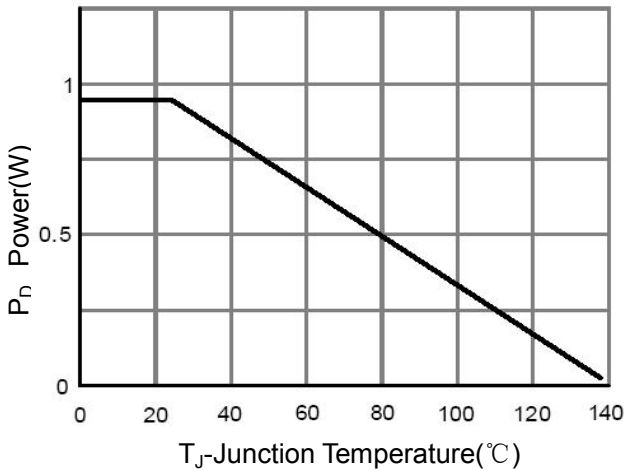

Figure 3 Power Dissipation

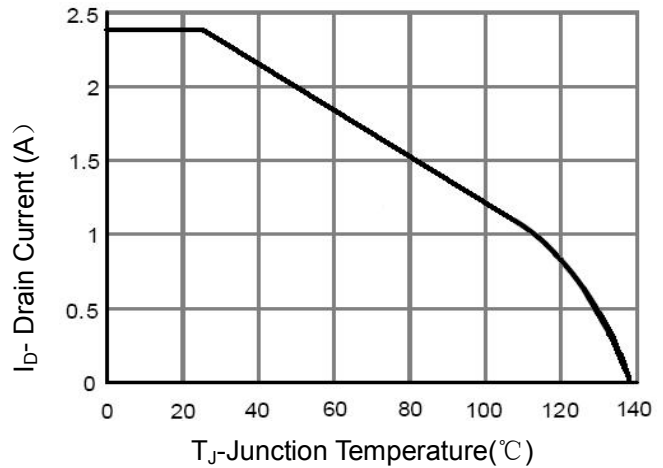

Figure 4 Drain Current

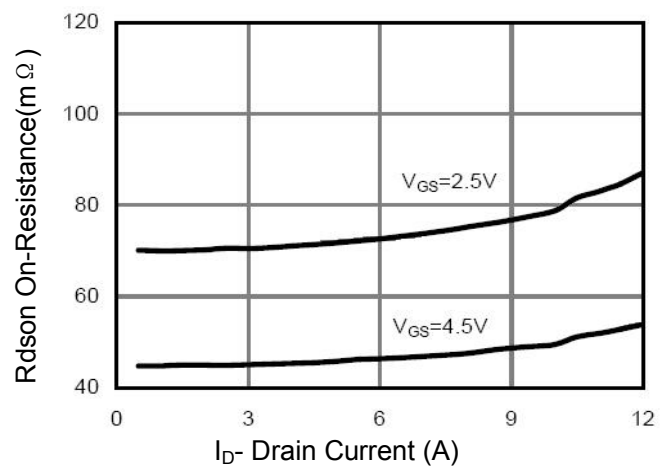
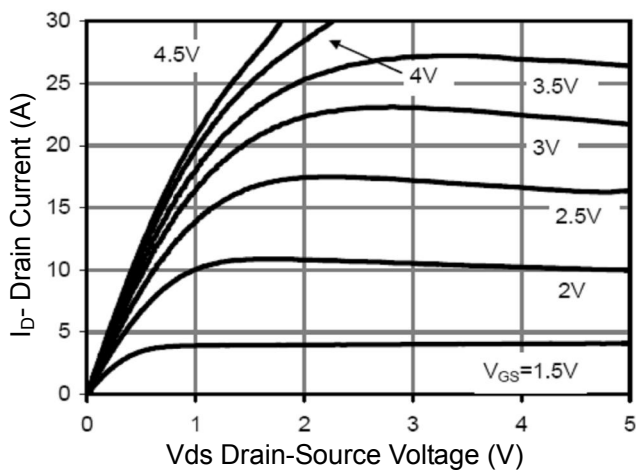

Figure 6 Drain-Source On-Resistance

Figure 5 Output CHARACTERISTICS

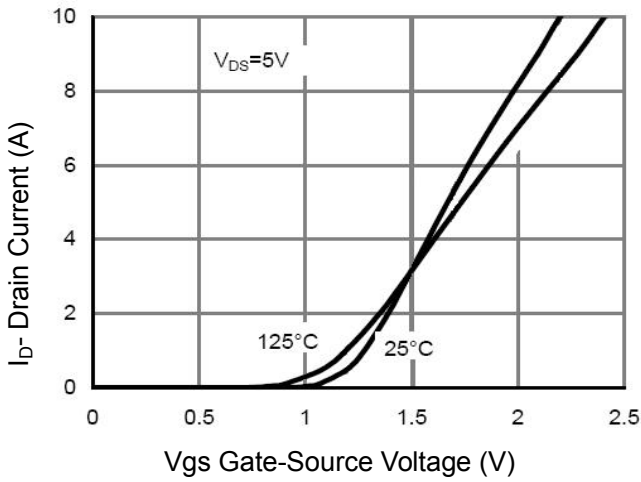

Figure 7 Transfer Characteristics

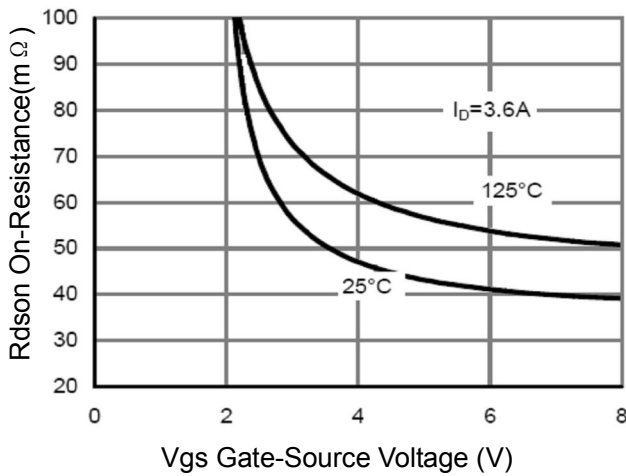

Figure 9 Rdson vs Vgs

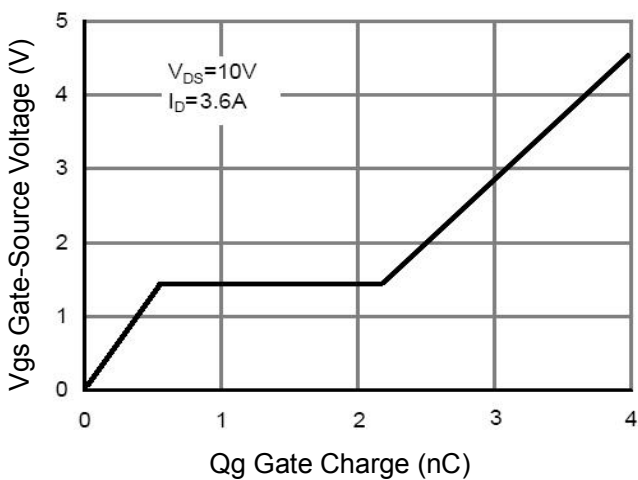

Figure 11 Gate Charge

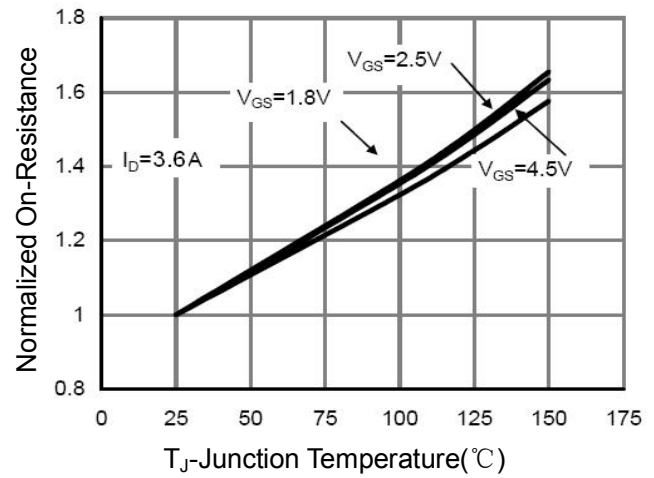

Figure 8 Drain-Source On-Resistance

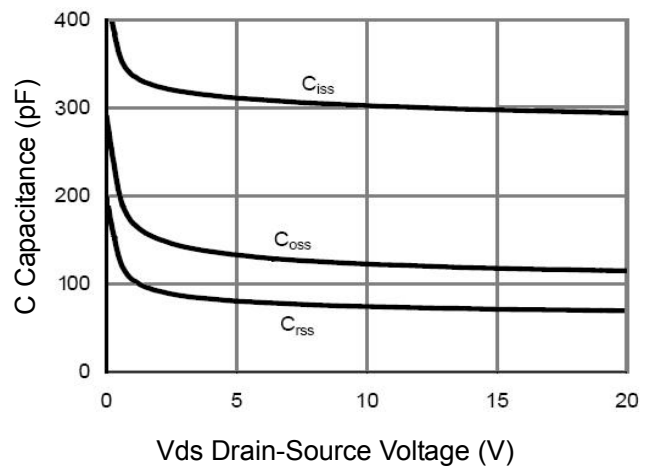

Figure 10 Capacitance vs Vds

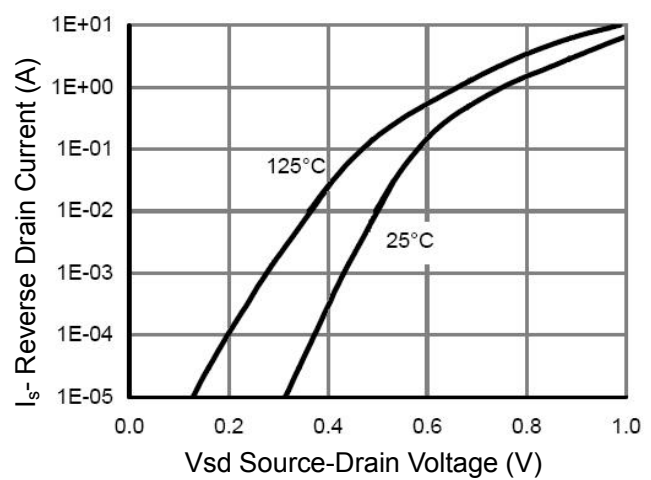

Figure 12 Source-Drain Diode Forward

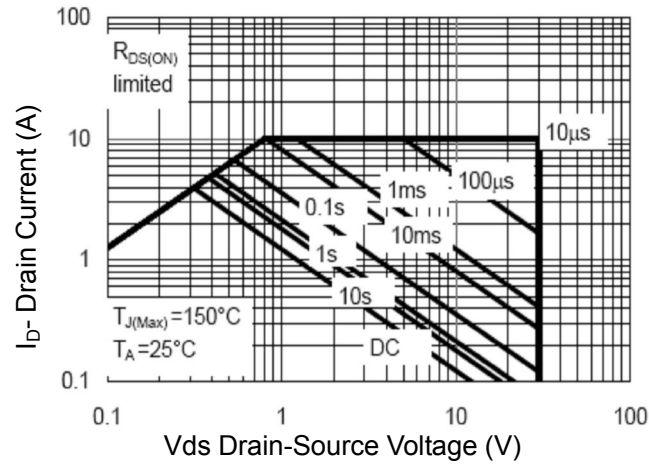

Figure 13 Safe Operation Area

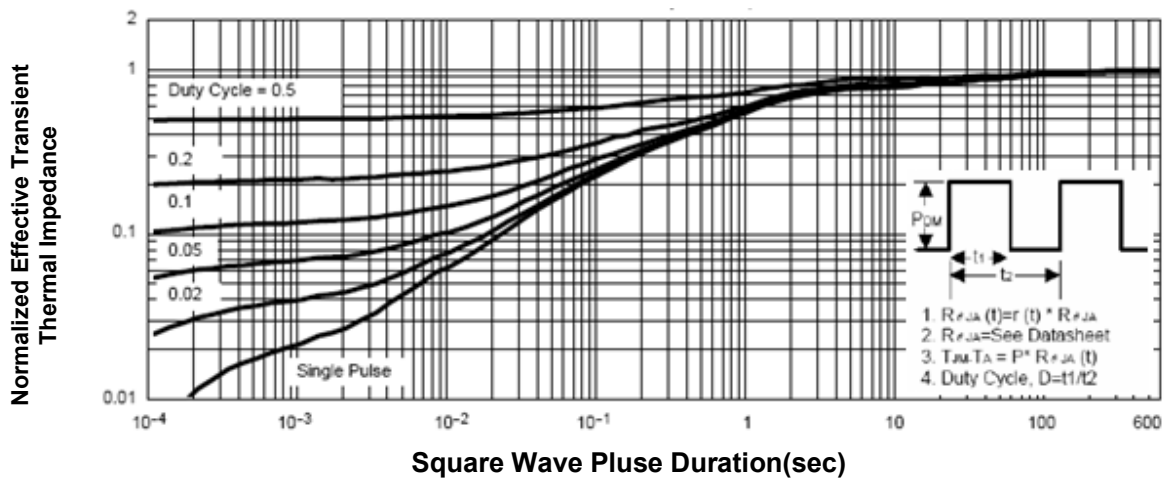
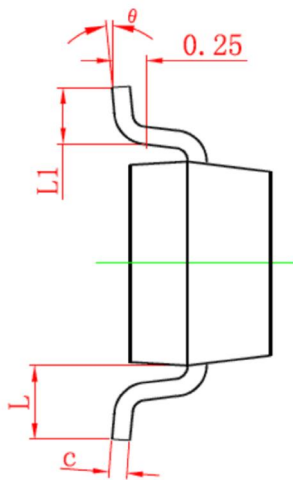
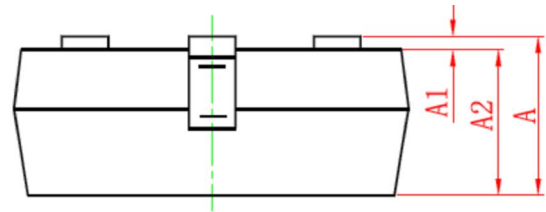
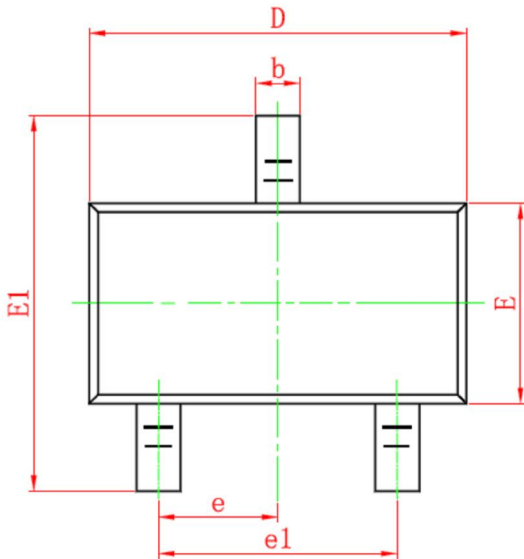

Figure 14 Normalized Maximum Transient Thermal Impedance

SOT-23 PACKAGE INFORMATION

Dimensions in Millimeters (UNIT:mm)



Symbol	Dimensions in Millimeters	
	MIN.	MAX.
A	0.900	1.150
A1	0.000	0.100
A2	0.900	1.050
b	0.300	0.500
c	0.080	0.150
D	2.800	3.000
E	1.200	1.400
E1	2.250	2.550
e	0.950TYP	
e1	1.800	2.000
L	0.550REF	
L1	0.300	0.500
θ	0°	8°

NOTES

- All dimensions are in millimeters.
- Tolerance $\pm 0.10\text{mm}$ (4 mil) unless otherwise specified
- Package body sizes exclude mold flash and gate burrs. Mold flash at the non-lead sides should be less than 5 mils.
- Dimension L is measured in gauge plane.
- Controlling dimension is millimeter, converted inch dimensions are not necessarily exact.