

Ansicht X
M 5:1

Bestückung kraftlos
powerless assembly

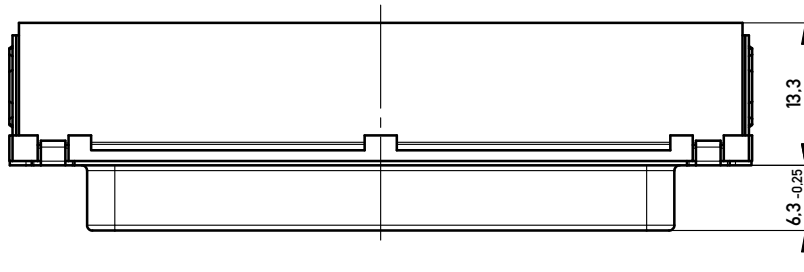
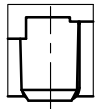

Mutter / nut

Gewinde / thread
M3 / #4-40

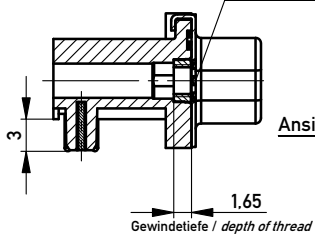

Bolzen / bolt

Gewinde / thread
M3 / #4-40

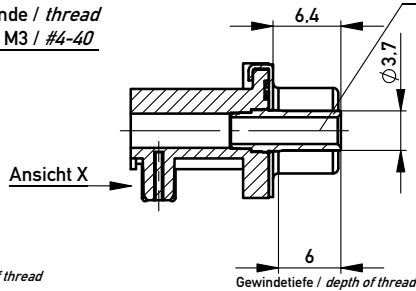

ohne / without

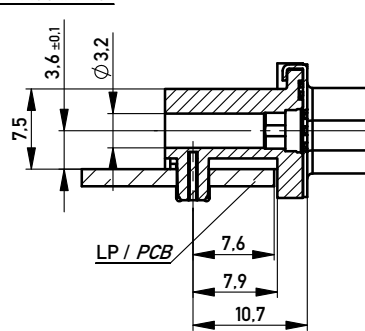

Anschlussbereich verzinkt
terminal area tin plating

Anforderungsstufe: 2
class: 2

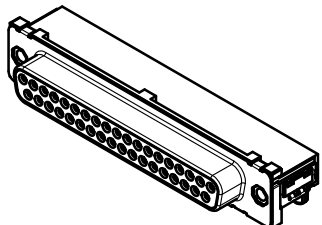

Verpackt in Tray
Verpackungseinheit 16 Stück
tray packaging
packaging unit 16 pcs

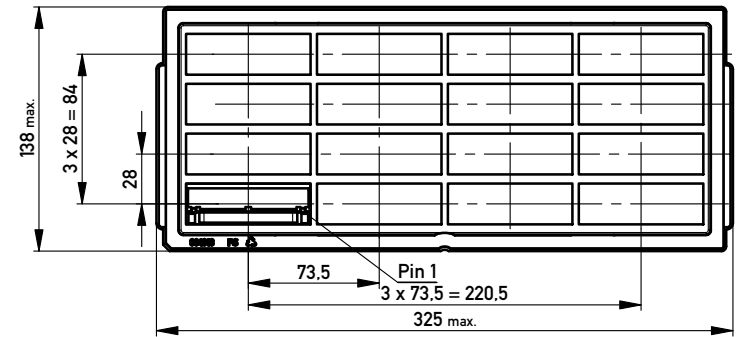

Sonstige Angaben siehe Zeichnung 204630 / additional indications according to drawing 204630

Verpackt in Gurtverpackung - Tape on Reel Packaging
Verpackungseinheit: 125 Stück - Packaging unit: 125 pcs

Abspulrichtung - Reel off Direction



Sonstige Angaben siehe Zeichnung 204656 / additional indications according to drawing 204656

Layoutvorschlag
recommended layout

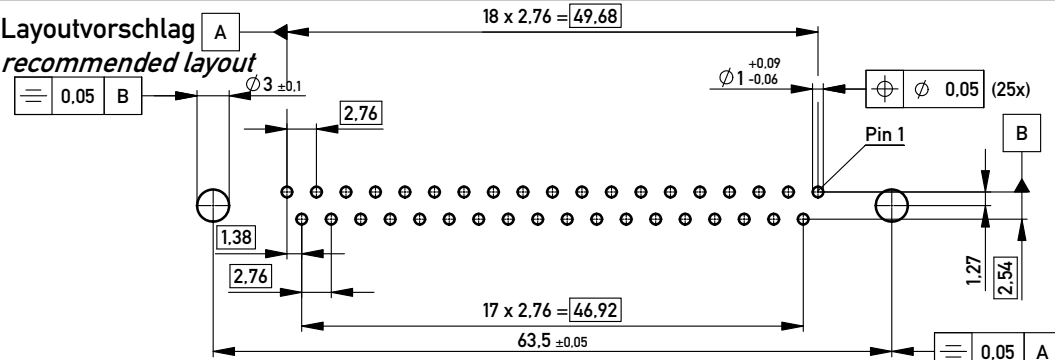

Sonstige Angaben siehe Zeichnung 204627 / additional indications according to drawing 204627

Fehlende Masse und Angaben siehe DIN 41652 / Missing information and dimensions according to DIN 41652

Sonstige Angaben siehe Fertigungsunterlagen / Additional indications according to production documentation

	204509	Ø3.2			
	204508			#4-40	
	204507			M3	
	204506		#4-40		
	204505		M3		
Ident-Nr. part-no. Gurt tape on reel	Ident-Nr. part-no. Tray tray	ohne without	Mutter nut	Bolzen bolt	Bemerkung remark

Copyright by ERNI GmbH
Proprietary notice pursuant to ISO 9006 to be observed.

Information:
All rights reserved.
Only for Information.
To ensure that this is the latest version of this drawing, please contact one of the ERNI companies before using.

Tolerances
Scale 2:1
All Dimensions in mm
Designation
TMC-S-37-THR 0M-Euro-BA8
TMC-S-37-THR 0M-Euro-BA8
www.ERNI.com
25.11.2011
Date

204504
Class TMCS
A3