

Mini-spectrometers

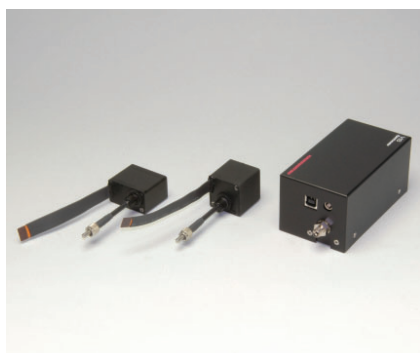

[RC series]

C11007MA
C11009MA

C11008MA
C11010MA

Compact and low cost
C11009MA, C11010MA: for installation into measurement equipment

Hamamatsu mini-spectrometer RC series is a family of compact polychromators integrated with a reflection grating and a CMOS linear image sensor. Two types are available: mini-spectrometer modules (C11007MA, C11008MA) with a driver circuit, and mini-spectrometer heads (C11009MA, C11010MA) for installation into measurement equipment, which contain an optical system and an image sensor in a compact case.

Mini-spectrometer modules have a USB port that connects to a PC for spectrum data collection. They come with sample software for setting measurement conditions, acquiring and saving data, and displaying data graphs, as well as with evaluation software and DLL. In mini-spectrometer heads, incident light is dispersed into a spectrum which is photoelectrically converted by the image sensor and output as video signals.

Features

C11007MA, C11008MA (Module)

- Integrating spectrometer head and drive circuit
- Spectral measurement using PC
- No external power supply required: USB bus power
- A/D conversion: 16-bit
- Wavelength conversion factor*1 is recorded in internal memory.

C11009MA, C11010MA (Head)

- For installation into measurement equipment
- Integrating optical system and image sensor into a compact case
C11009MA: 28 × 28 × 28 mm
C11010MA: 35 × 28 × 20 mm
- Low cost
- Wavelength conversion factor*1 is listed on test result sheet.

Applications

C11007MA, C11009MA

- Installation into measurement equipment
- Chemical measurement
- Visible light source testing
- Color measurement, etc.

C11008MA, C11010MA

- Installation into measurement equipment
- Chemical measurement
- Measurement of saccharic in fruits
- Various industrial measurements

*1: A conversion factor for converting the image sensor pixel number into a wavelength is recorded in the module. Calculation factor for converting the A/D converted count into the input light level is not provided.

Selection guide

■ Spectrometer modules

Type no.	Product type	Spectral response range (nm)	Spectral Resolution max. (nm)	Interface	Light input method
C11007MA	RC-VIS-MOS	340 to 780	9	USB 1.1	fiber
C11008MA	RC-SWNIR-MOS	640 to 1050	8		

■ Spectrometer heads (for installation into measurement equipment)

C11009MA	RC-VIS-MOS	340 to 780	9	-	fiber
C11010MA	RC-SWNIR-MOS	640 to 1050	8		

Structure of C11009MA, C11010MA

The C11009MA, C11010MA are offered in small size, low-cost units achieved by integrating optical components into a glass body. The reflective grating mounted on the glass body is a plastic-molded replica grating.

Optical component layout

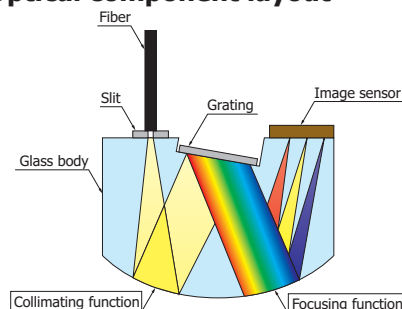

KACCC0348EB

Optical characteristics

Parameter	RC-VIS-MOS		RC-SWNIR-MOS		Unit
	C11007MA (Spectrometer module)	C11009MA (Spectrometer head)	C11008MA (Spectrometer module)	C11010MA (Spectrometer head)	
Spectral response range	340 to 780		640 to 1050		nm
Spectral resolution (Spectral response half width)*2	9 max.		8 max.		nm
Wavelength reproducibility*3	-0.5 to +0.5				nm
Wavelength temperature dependence	-0.05 to +0.05				nm/°C
Spectral stray light*2*4	-30 max.				dB

*2: Depends on the slit opening. Values were measured with the slit listed in the table "Structure".

*3: Measured under constant light input conditions

*4: When monochromatic light of $\lambda=550$ nm (C11007MA, C11009MA) or $\lambda=850$ nm (C11008MA, C11010MA) is input, spectral stray light is defined as the ratio of the count measured at the input wavelength, to the count measured at a wavelength 40 nm longer or shorter than the input wavelength.

Electrical characteristics

Parameter	C11007MA (Spectrometer module)	C11009MA (Spectrometer head)	C11008MA (Spectrometer module)	C11010MA (Spectrometer head)	Unit
A/D conversion	16	-	16	-	bits
Integration time	5 to 10000	-	5 to 10000	-	ms
Interface	USB 1.1	-	USB 1.1	-	-
Power consumption	-	15	-	25	mW
Output impedance*5	-	1	-	1	k Ω

*5: An increase in the current consumption at the video output terminal also increases the chip temperature and so causes the dark current to rise. To avoid this, connect a buffer amplifier for impedance conversion to the video output terminal so that the current flow is minimized. As the buffer amplifier, use a JFET or CMOS input operational amplifier of optical input impedance.

Structure

Parameter	C11007MA (Spectrometer module)	C11009MA (Spectrometer head)	C11008MA (Spectrometer module)	C11010MA (Spectrometer head)	Unit
Dimensions (W × D × H)	55 × 100 × 48	28 × 28 × 28	55 × 100 × 48	35 × 28 × 20	mm
Weight	180	52	168	45	g
Built-in head	C11009MA	-	C11010MA	-	-
Image sensor	CMOS linear image sensor (S8378-256N)		Infrared enhanced type CMOS linear image sensor		-
Number of pixels	256				pixels
Slit*6 (H × V)	70 × 550		70 × 2500		μ m
NA*7	0.22				-
Fiber core diameter	600				μ m
Optical fiber connector	SMA905				-

*6: Entrance slit aperture size of the incorporated image sensor

*7: Numeric aperture (solid angle)

Absolute maximum ratings

Parameter	C11007MA (Spectrometer module)	C11009MA (Spectrometer head)	C11008MA (Spectrometer module)	C11010MA (Spectrometer head)	Unit
Operating temperature*8			+5 to +40		°C
Storage temperature*8			-20 to +70		°C

*8: No condensation

Note: Exceeding the absolute maximum ratings even momentarily may cause a drop in product quality. Always be sure to use the product within the absolute maximum ratings.

Spectral resolution vs. wavelength (typical example)

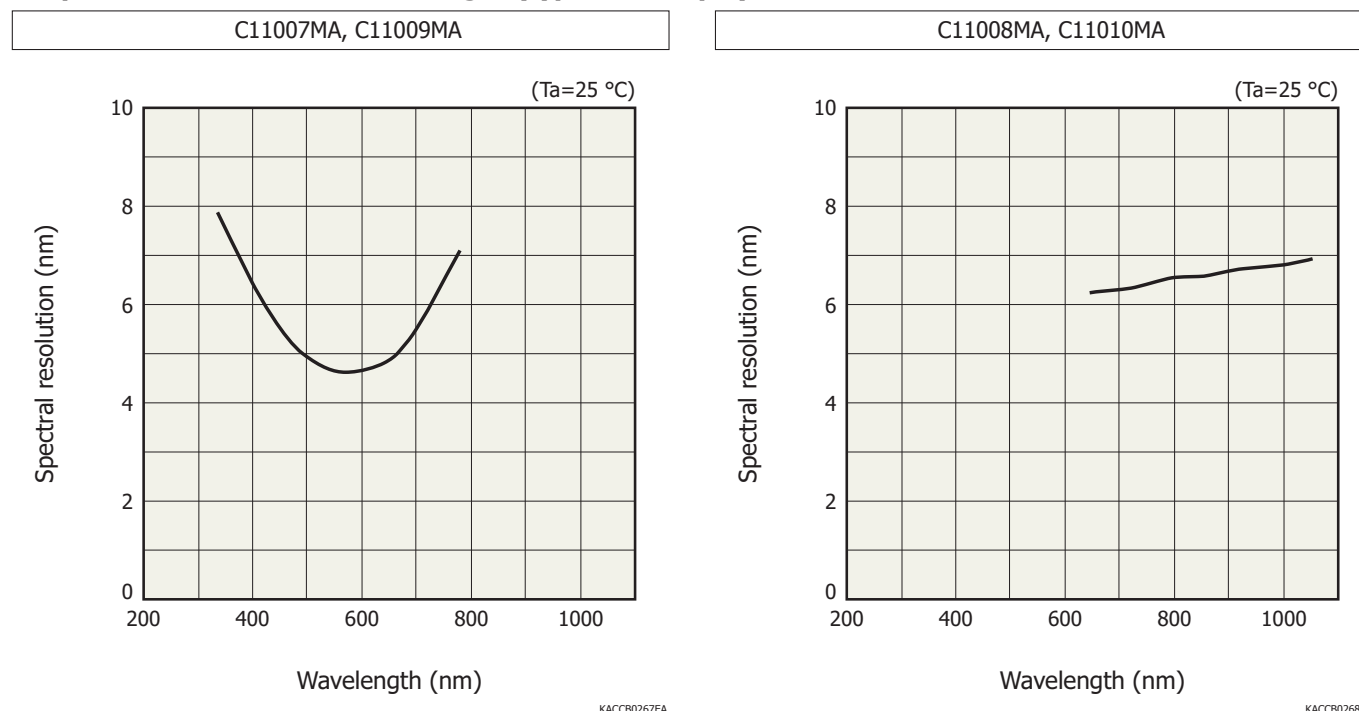

Linearity (typical example)

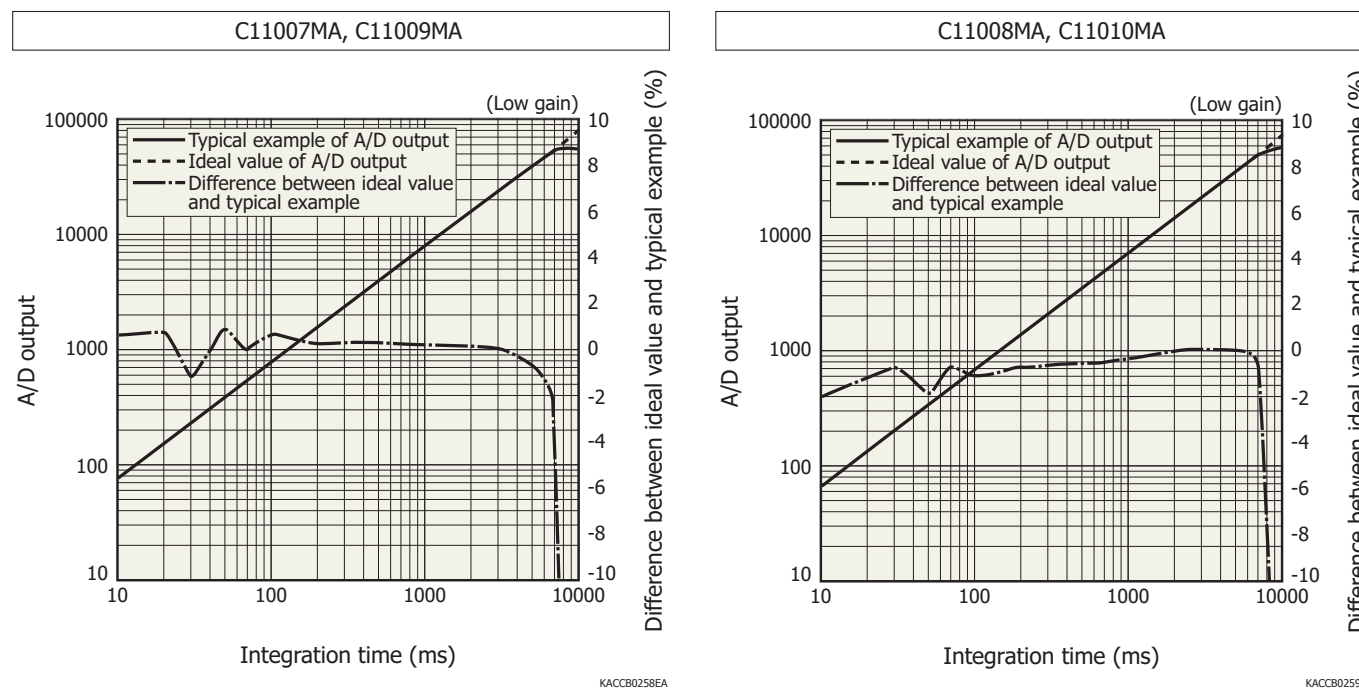

A/D output is the output with dark output is subtracted when light is input. The difference between the ideal value and typical example contains a measurement error. The smaller the A/D output, the larger the measurement error.

Dark output vs. ambient temperature (typical example)

C11007MA, C11009MA

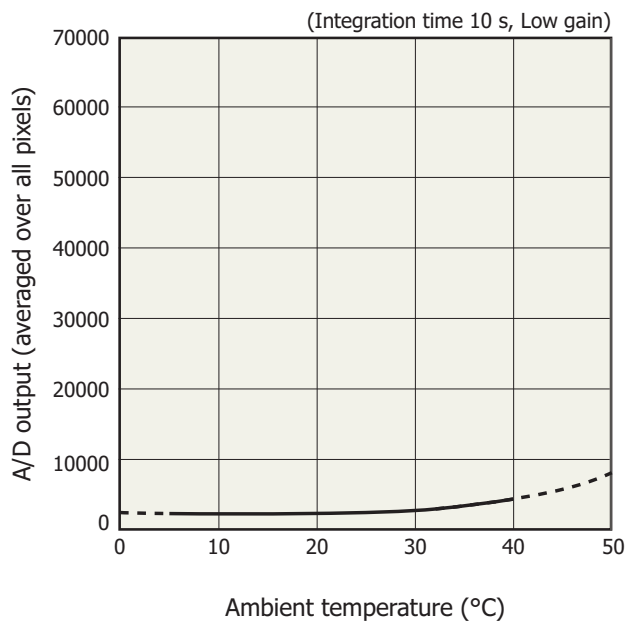

KACCB0260EA

C11008MA, C11010MA

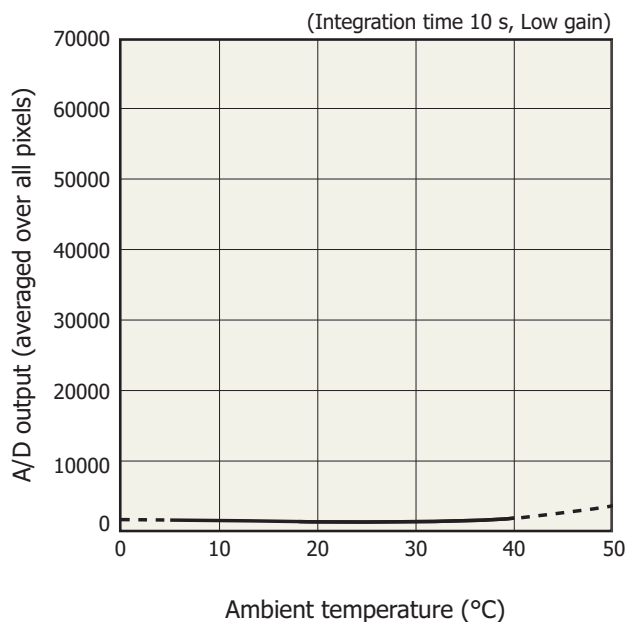

KACCB0261EA

A/D output is the sum of the sensor and circuit offset outputs and the sensor dark output.

Dimensional outlines (unit: mm)

C11007MA

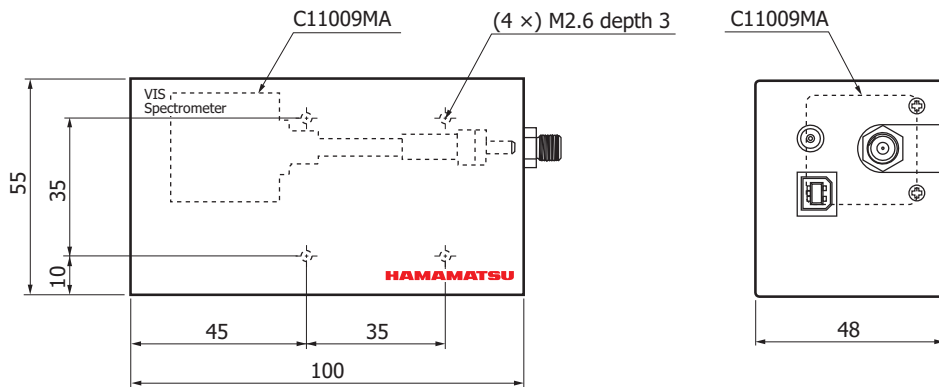

Tolerance unless otherwise noted: ± 0.5
Weight: 180 g

KACCA0240EB

C11009MA

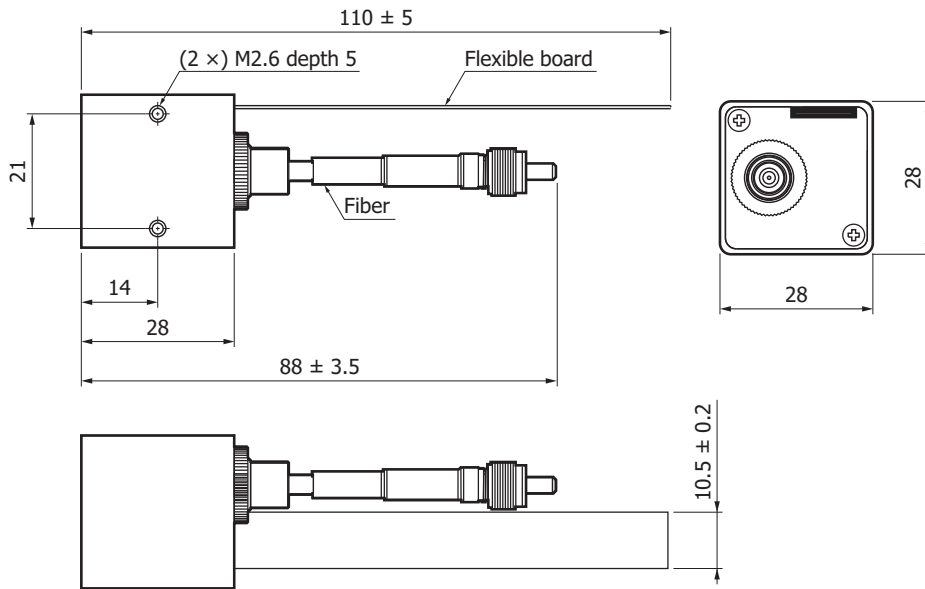

Tolerance unless otherwise noted: ± 0.5
 Weight: 52 g

KACCA0241EB

C11008MA

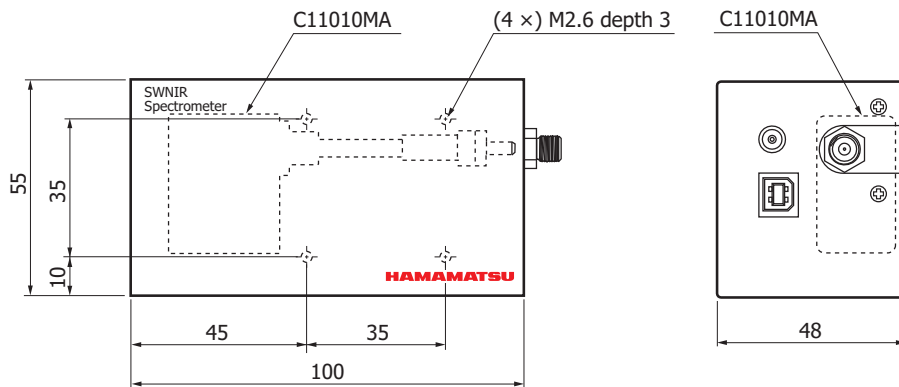

Tolerance unless otherwise noted: ± 0.5
 Weight: 168 g

KACCA0242EB

C11010MA

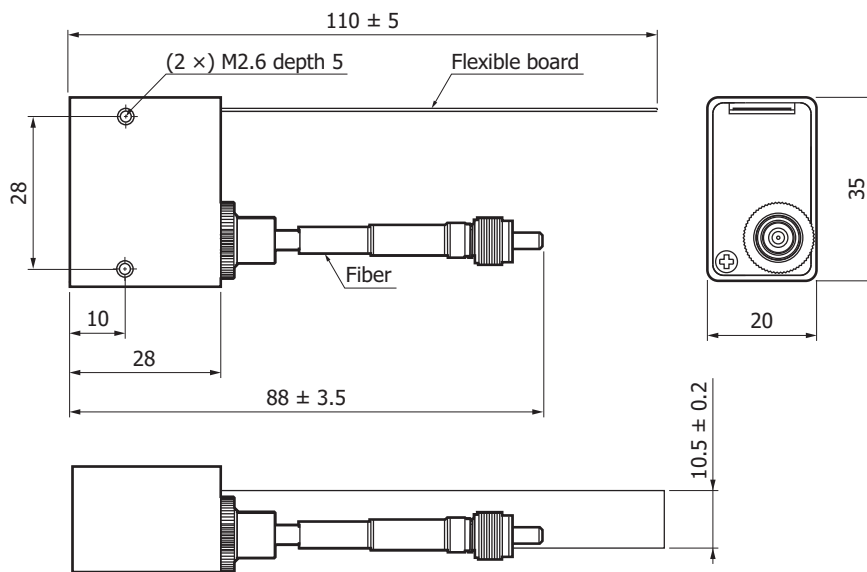

Tolerance unless otherwise noted: ± 0.5
 Weight: 45 g

KACCA0243EB

Connection example (transmission light measurement)

Light to be measured is guided into the entrance port of RC series through an optical fiber and the spectrum measured with the built-in image sensor is output through the USB port to a PC for data acquisition.

There are no moving parts inside the unit so stable measurement are obtained at all times. An optical fiber that guides light input from external sources allows a flexible measurement setup.

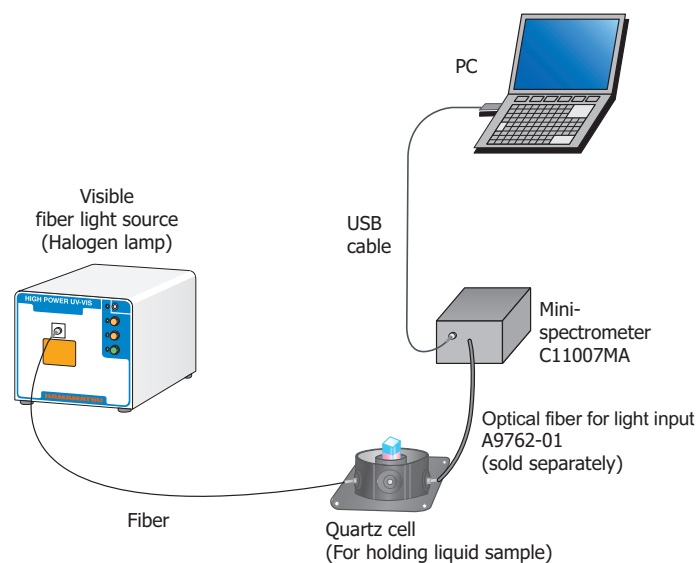

KACCC0468EA

Light input method

For mini-spectrometer head (C11009MA, C11010MA), an SMA connector is attached with the other end of the optical fiber. Light can be easily guided by hooking up this connector to the SMA receptacle of an external unit. If the optical fiber connected to mini-spectrometer RC series is shorter than needed, an optical fiber of the desired length can be added by connecting a relay unit.

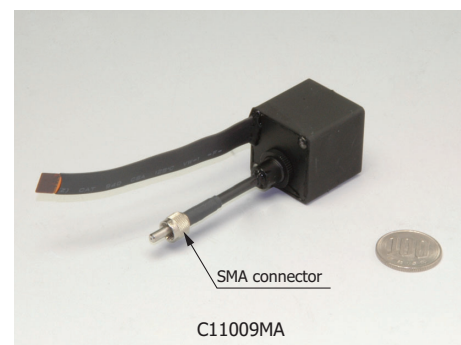

➤ Optical fibers for light input (A9762-01, A9763-01)

As options for use with mini-spectrometers (C11007MA, C11008MA), Hamamatsu provides optical fibers for UV/visible range (UV resistant) and for visible/near infrared range (core diameter 600 μm , sold separately). The mini-spectrometers (C11009MA, C11010MA) integrate an optical fiber.

Type no.	Product name	Applicable mini-spectrometer	Core diameter (μm)	Specification
A9762-01	Fiber for UV/visible range (resistance to UV)	C11007MA	600	NA=0.22, length 1.5 m, connectorized SMA905D at both ends
A9763-01	Fiber for visible/near infrared range	C11008MA		

➤ Electrical connections with an external circuit (C11009MA, C11010MA)

The flexible printed circuit board protruding from the mini-spectrometer is used make electrical connections to an external circuit.

· Mating connectors:

FH12-20S-0.5SV vertical type (made by HIROSE electric)

FH12-52745-2090 horizontal type (made by MOLEX)

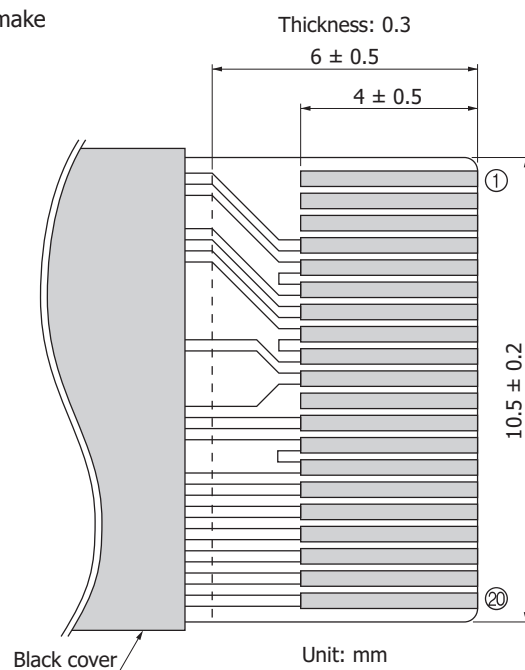

KACCC0261EB

Pin no.	Terminal name	I/O	Discription	Pin no.	Terminal name	I/O	Discription
①	NC	-	No connection	⑪	NC	-	No connection
②	NC	-	No connection	⑫	GAIN	I	Image sensor: gain setting
③	NC	-	No connection	⑬	A.GND	-	Analog GND
④	EOS	O	EOS (end of scan) signal	⑭	A.GND	-	Analog GND
⑤	A.GND	-	Analog GND	⑮	ST	I	Sensor scan start signal
⑥	A.GND	-	Analog GND	⑯	CLK	I	Sensor scan sync signal
⑦	VIDEO	O	Video signal output	⑰	SDA	O	Thermosensor output signal
⑧	A.GND	-	Analog GND	⑱	SCL	I	Thermosensor driver signal
⑨	A.GND	-	Analog GND	⑲	D.GND	-	Thermosensor digital GND
⑩	+5 V	I	Power supply of image sensor: +5 V	⑳	VCC	I	Power supply of thermosensor: +3.3 V

Note:

· Pins 4 to 10 and 12 to 16 are connected to the image sensor.

For information on drive specifications, refer to "CMOS linear image sensor S8377/S8378 series" datasheet.

· Pins 17 to 20 are connected to the internal thermosensor (DALLAS DS1775R).

❏ Procautions (C11009MA, C11010MA)

- Avoid excessive or repeated bending and stretching of the flexible board, which may cause an open-circuit fault. Do not bend the flexible board to the point where folds or creases occur.
- Avoid pulling, twisting or excessive bending of the optical fiber, which may damage the optical components in the mini-spectrometer or the optical fiber itself. To prevent applying stress to the optical fiber, provide slotted mounting holes in the equipment enclosure where the head-type mini-spectrometer is to be installed. Make sure these slotted holes are aligned along the same direction as the optical fiber. When installing the mini-spectrometer, first clamp the optical fiber SMA connector and then use the slotted holes to secure the mini-spectrometer at a position where the optical fiber is free from stress.

❏ Evaluation software (C11007MA, C11008MA)

Installing the evaluation software package (RCEvaluation.exe)^{*9} into your PC allows running the following basic tasks:

- Measurement data acquisition and save
- Measurement condition setup
- Module information acquisition (wavelength conversion factor, polychromator type, etc)
- Graphic display
- Arithmetic operation
 - Pixel number to wavelength conversion
 - Comparison calculation with reference data (transmittance, reflectance)
 - Dark subtraction
 - Gaussian approximation (peak position and count, FWHM)

Note:

- This product cannot operate with the software that comes with the mini-spectrometer TM or TG series.
- The external trigger input function does not work with the evaluation software. If using an external trigger input or designing original application software, the user software must be configured to support that function.

*9: Compatible OS: Microsoft® Windows® 7 Professional SP1 (32-bit)^{*10}
Microsoft® Windows® 7 Professional SP1 (64-bit)^{*10}

DLL for controlling hardware is also provided.

You can develop your own measurement programs by using a following software development environment.

Microsoft® Visual Studio® 2008 (SP1) Visual C++®^{*10}

Microsoft® Visual Studio® 2008 (SP1) Visual Basic®^{*10}

*10: Microsoft, Windows, Visual Studio, Visual C++ and Visual Basic are either registered trademarks or trademarks of Microsoft Corporation in the United States and other countries.

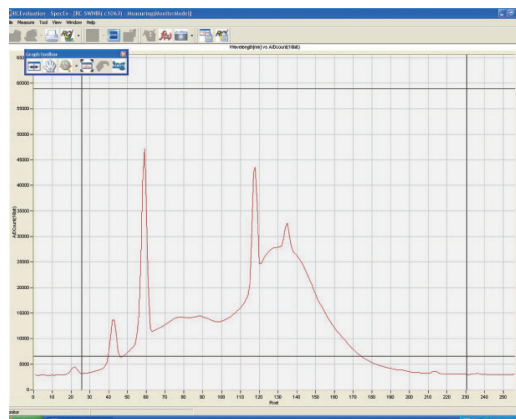

Measurement examples (C11007MA)

White LED and 3-color LED measurements

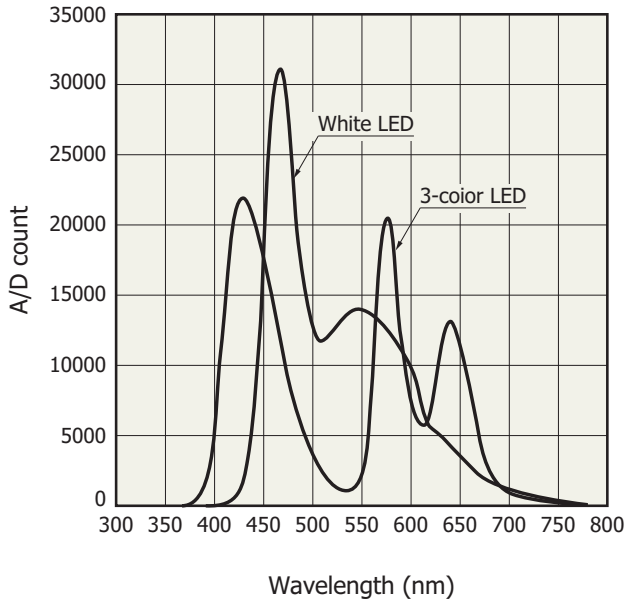

KACCB0100EA

Reflected light from color paper

Relative reflectance with 100% being equal to reflectance of white plate

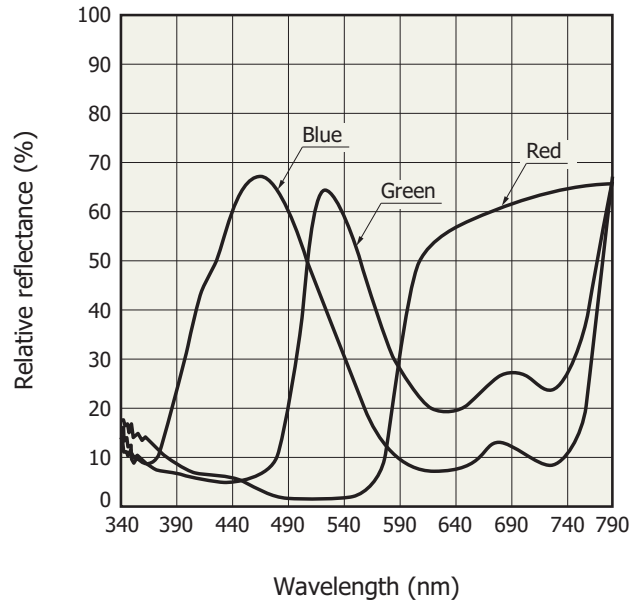

KACCB0102EA

Accessories (C11007MA, C11008MA only)

- USB cable
- Dedicated software (evaluation software, sample software, DLL)

Mini-spectrometer lineup

Type no.	Type	Spectral response range (nm)													Spectral resolution max. (nm)	Image sensor			
		200	400	600	800	1000	1200	1400	1600	1800	2000	2200	2400	2600					
C10082CA	TM-UV/VIS-CCD High sensitivity																	6	Back-thinned CCD image sensor
C10082CAH	TM-UV/VIS-CCD High resolution		200 to 800															1*	
C10082MD	TM-UV/VIS-MOS Wide dynamic range																	6	CMOS linear image sensor
C10083CA	TM-VIS/NIR-CCD High sensitivity																	8 (λ=320 to 900 nm)	Back-thinned CCD image sensor
C10083CAH	TM-VIS/NIR-CCD High resolution																	1* (λ=320 to 900 nm)	
C10083MD	TM-VIS/NIR-MOS Wide dynamic range				320 to 1000													8	CMOS linear image sensor
C11697MB	TM-VIS/NIR-MOS-II Trigger-compatible																	8	High-sensitivity CMOS linear image sensor
C9404CA	TG-UV-CCD High sensitivity		200 to 400															3	Back-thinned CCD image sensor
C9404CAH	TG-UV-CCD High resolution																	1*	Back-thinned CCD image sensor
C9405CB	TG-SWNIR-CCD-II IR-enhanced				500 to 1100													5 (λ=550 to 900 nm)	IR-enhanced Back-thinned CCD image sensor
C11713CA	TG-RAMAN-I High resolution				500 to 600													0.3*	Back-thinned CCD image sensor
C11714CA	TG-RAMAN-II High resolution						790 to 920											0.3*	Back-thinned CCD image sensor
C11482GA	TG2-NIR Non-cooled type								900 to 1700									7	InGaAs linear image sensor
C9913GC	TG-cooled NIR-I Low noise (cooled type)																	7	
C9914GB	TG-cooled NIR-II Low noise (cooled type)									1100 to 2200								8	
C11118GA	TG-cooled NIR-III Low noise (cooled type)									900 to 2550								20	
C13053MA	FT-SWIR-MOS-II Compact, thin				500 to 1100													3.5	High sensitivity CMOS linear image sensor
C11007MA	RC-VIS-MOS Spectrometer module		340 to 780															9	CMOS linear image sensor
C11008MA	RC-SWNIR-MOS Spectrometer module				640 to 1050													8	IR-enhanced CMOS linear image sensor

* Typ.

For installation into mobile measuring equipment

Type no.	Type	Spectral response range (nm)													Spectral resolution max. (nm)	image sensor			
		200	400	600	800	1000	1200	1400	1600	1800	2000	2200	2400	2600					
C11009MA	RC-VIS-MOS Spectrometer head		340 to 780															9	CMOS linear image sensor
C11010MA	RC-SWNIR-MOS Spectrometer head				640 to 1050													8	IR-enhanced CMOS linear image sensor

For installation into mobile measuring equipment

Type no.	Type	Spectral response range (nm)													Spectral resolution max. (nm)	image sensor			
		200	400	600	800	1000	1200	1400	1600	1800	2000	2200	2400	2600					
C10988MA-01	MS-VIS-MOS Spectrometer head		340 to 750															14	CMOS linear image sensor
C11708MA	MS-SWNIR-MOS Spectrometer head				640 to 1050													20	
C12666MA	Spectrometer head		340 to 780															15	CMOS linear image sensor

Related information

www.hamamatsu.com/sp/ssd/doc_en.html

■ Precautions

- Notice
- Mini-spectrometers/Precautions

■ Technical information

- Mini-spectrometers/Technical information

Information described in this material is current as of November, 2014.

Product specifications are subject to change without prior notice due to improvements or other reasons. This document has been carefully prepared and the information contained is believed to be accurate. In rare cases, however, there may be inaccuracies such as text errors. Before using these products, always contact us for the delivery specification sheet to check the latest specifications.

The product warranty is valid for one year after delivery and is limited to product repair or replacement for defects discovered and reported to us within that one year period. However, even if within the warranty period we accept absolutely no liability for any loss caused by natural disasters or improper product use.

Copying or reprinting the contents described in this material in whole or in part is prohibited without our prior permission.

HAMAMATSU

www.hamamatsu.com

HAMAMATSU PHOTONICS K.K., Solid State Division

1126-1 Ichino-cho, Higashi-ku, Hamamatsu City, 435-8558 Japan, Telephone: (81) 53-434-3311, Fax: (81) 53-434-5184

U.S.A.: Hamamatsu Corporation: 360 Foothill Road, Bridgewater, N.J. 08807, U.S.A., Telephone: (1) 908-231-0960, Fax: (1) 908-231-1218

Germany: Hamamatsu Photonics Deutschland GmbH: Arzbergerstr. 10, D-82211 Herrsching am Ammersee, Germany, Telephone: (49) 8152-375-0, Fax: (49) 8152-265-8

France: Hamamatsu Photonics France S.A.R.L.: 19, Rue du Saule Trapu, Parc du Moulin de Massy, 91882 Massy Cedex, France, Telephone: 33-(1) 69 53 71 00, Fax: 33-(1) 69 53 71 10

United Kingdom: Hamamatsu Photonics UK Limited: 2 Howard Court, 10 Tewin Road, Welwyn Garden City, Hertfordshire AL7 1BW, United Kingdom, Telephone: (44) 1707-294888, Fax: (44) 1707-325777

North Europe: Hamamatsu Photonics Norden AB: Torshamnsgatan 35 16440 Kista, Sweden, Telephone: (46) 8-509-031-00, Fax: (46) 8-509-031-01

Italy: Hamamatsu Photonics Italia S.r.l.: Strada della Moia, 1 int. 6, 20020 Arese (Milano), Italy, Telephone: (39) 02-93581733, Fax: (39) 02-93581741

China: Hamamatsu Photonics (China) Co., Ltd.: B1201, Jiaming Center, No.27 Dongsanhuan Beilu, Chaoyang District, Beijing 100020, China, Telephone: (86) 10-6586-6006, Fax: (86) 10-6586-2866