



# MLG2-1040A812

MLG

MEASURING AUTOMATION LIGHT GRIDS

**SICK**  
Sensor Intelligence.

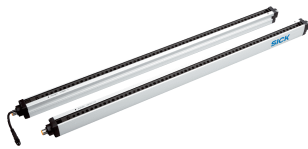

### Ordering information

Type	Part no.
MLG2-1040A812	1060859

Other models and accessories → [www.sick.de/MLG](http://www.sick.de/MLG)



### Detailed technical data

#### Features

<b>Technology</b>	Sender/receiver
<b>Minimum detectable object (MDO)</b>	Parallel beam, 25 mm
<b>Beam separation</b>	20 mm
<b>Number of beams</b>	≥ 53
<b>Detection height</b>	1,040 mm
<b>Configuration</b>	Parameterization interface (measuring)

#### Performance

<b>Maximum range</b>	7 m <sup>1)</sup>
<b>Minimum range</b>	Parallel beam: ≥ 0 mm
<b>Working range</b>	5 m
<b>Response time</b>	Parallel beam ≥ 8.95 ms <sup>2)</sup>

<sup>1)</sup> No reserve for environmental issue and deterioration of the diode.

<sup>2)</sup> With resistive load.

#### Interfaces

<b>Switching output</b>	2 x Analog 1 x PNP
<b>Inputs</b>	1 x PNP
<b>Connection type</b>	Male connector M12, 8-pin

#### Mechanics/electronics

<b>Wave length</b>	Infrared light, 880 nm
<b>Supply voltage V<sub>s</sub></b>	DC 18 V ... 30 V
<b>Power consumption sender</b>	≥ 246 mA <sup>1)</sup>
<b>Power consumption receiver</b>	≥ 259 mA <sup>1)</sup>
<b>Ripple</b>	< 5 V <sub>pp</sub>
<b>Output current I<sub>max.</sub></b>	≤ 100 mA
<b>Output load capacitive</b>	100 nF
<b>Output load inductive</b>	1 H
<b>Initialization time</b>	1 s
<b>Dimensions (W x H x D)</b>	34 mm x 1,124 mm x 29 mm

<sup>1)</sup> Without load with 24 V.

<b>Housing material</b>	Aluminum
<b>Indication</b>	7-segment display, 7-segment display
<b>Synchronization</b>	Cable
<b>Enclosure rating</b>	IP 65
<b>Circuit protection</b>	U <sub>V</sub> connections, reverse polarity protected, Output Q short-circuit protected, Interference pulse suppression
<b>Weight</b>	≥ 2.892 kg
<b>Front screen</b>	PMMA

<sup>1)</sup> Without load with 24 V.

#### Ambient data

<b>Protection class</b>	III
<b>EMC</b>	EN 60947-5-2
<b>Ambient temperature</b>	Operation: -25 °C ... +55 °C Storage: -40 °C ... +70 °C
<b>Ambient light immunity</b>	Direct: 12,500 lx <sup>1)</sup> Indirect: 50,000 lx
<b>Vibration resistance</b>	5 g, 10 Hz ... 55 Hz (IEC 68-2-6)
<b>Shock load</b>	10 g / IEC 68-2-29 / 16 ms

<sup>1)</sup> Sunlight.

Dimensional drawing (Dimensions in mm (inch))

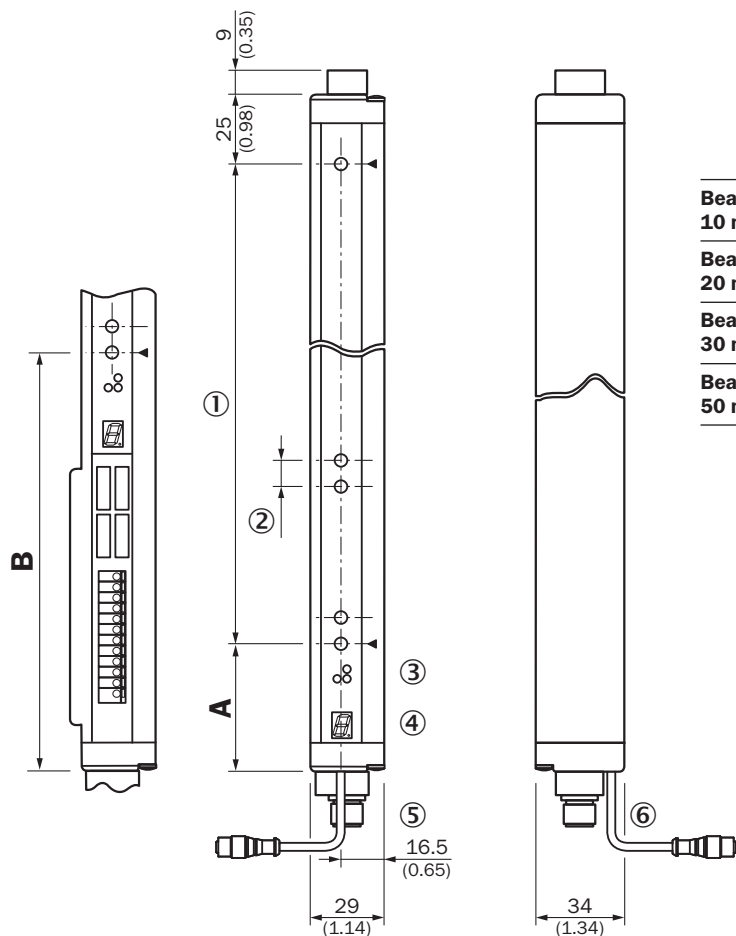

- ① Detection height (see optical performance)
- ② Beam separation (10, 20, 30, 50 mm)
- ③ Status indicator: green, yellow, red LEDs
- ④ Indicator panel, 7-segment display
- ⑤ Terminals: M16 cable entry/connector M12, 12-pin
- ⑥ Configuration connector M8, 4-pin

	<b>A</b>	<b>B</b>
	Distance: MLG edge - first beam	
<b>Beam separation MLG1</b>		
<b>10 mm</b>	49 (1.93)	160 (6.30)
<b>Beam separation MLG2</b>		
<b>20 mm</b>	49 (1.93) <sup>1)</sup>	170 (6.69) <sup>2)</sup>
<b>Beam separation MLG3</b>		
<b>30 mm</b>	69 (2.72)	180 (7.09)
<b>Beam separation MLG5</b>		
<b>50 mm</b>	89 (3.50)	200 (7.87)

<sup>1)</sup> With even number of beams.  
<sup>2)</sup> With odd number of beams.

## Adjustments



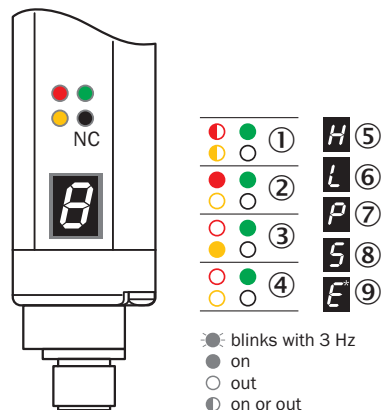

LED indicator





- ① Supply voltage
- ② Device error
- ③ No object in the light path
- ④ Contamination control
- ⑤ Blocked Beams Hold (BBH)
- ⑥ Activated teach-in procedure
- ⑦ ParamMode is active
- ⑧ Standby
- ⑨ Error: E1 = sync. error; E2 = less receiver signal; E9 = defect

## Recommended accessories

Other models and accessories → [www.sick.de/MLG](http://www.sick.de/MLG)

	Brief description	Type	Part no.
<b>Mounting brackets and mounting plates</b>			
	Side mounting with T-nuts, 4 pieces, mounting hardware included	BEF-NUT-MLG	2023696
	Metal mounting bracket, compact, steel, zinc coated, Set, consisting of 4 pieces, without mounting hardware	BEF-WK-XLG	2029100
<b>Terminal and alignment brackets</b>			
	4 pieces, Mounting kit 1, rotatable, swivel mount, plastic	BEF-2SMKEAKU4	2019649
<b>Adapters and distributors</b>			
	Male connector M12, 8-pin, straight, to 1 x female connector M12, 8-pin, straight and 1 x female connector M12, 8-pin, straight	SBO-02F12-SM	6029306
<b>Plug connectors and cables</b>			

	<b>Brief description</b>	<b>Type</b>	<b>Part no.</b>
	Head A: female connector, M12, 8-pin, straight Head B: cable Cable: PVC, shielded, 2 m	DOL-1208-G02MA	6020633
	Head A: female connector, M12, 8-pin, straight Head B: cable Cable: PVC, shielded, 5 m	DOL-1208-G05MA	6020993
	Head A: female connector, M12, 8-pin, straight Head B: cable Cable: PVC, shielded, 10 m	DOL-1208-G10MA	6022152
	Head A: female connector, M12, 8-pin, angled Head B: cable Cable: PVC, shielded, 2 m	DOL-1208-W02MA	6020992
	Head A: female connector, M12, 8-pin, angled Head B: cable Cable: PVC, shielded, 5 m	DOL-1208-W05MA	6021033
	Head A: female connector, M8, 4-pin, straight Head B: female connector, D-Sub, 9-pin, straight Cable: unshielded, 2 m Rectangular plug-in system, parameterization cable	DSL-8D04-G02M	2023695
	Head A: female connector, M12, 8-pin, straight Head B: male connector, M12, 8-pin, straight Cable: drag chain use, PUR, halogen-free, shielded, 2 m	DSL-1208-G02MAC	6030121
	Head A: female connector, M12, 8-pin, straight Head B: male connector, M12, 8-pin, straight Cable: drag chain use, PUR, halogen-free, shielded, 5 m	DSL-1208-G05MAC	6032325
	Head A: female connector, M12, 8-pin, straight Head B: male connector, M12, 8-pin, straight Cable: drag chain use, PUR, halogen-free, shielded, 10 m	DSL-1208-G10MAC	6034901

## SICK AT A GLANCE

SICK is one of the leading manufacturers of intelligent sensors and sensor solutions for industrial applications. A unique range of products and services creates the perfect basis for controlling processes securely and efficiently, protecting individuals from accidents and preventing damage to the environment.

We have extensive experience in a wide range of industries and understand their processes and requirements. With intelligent sensors, we can deliver exactly what our customers need. In application centers in Europe, Asia and North America, system solutions are tested and optimized in accordance with customer specifications. All this makes us a reliable supplier and development partner.

Comprehensive services complete our offering: SICK LifeTime Services provide support throughout the machine life cycle and ensure safety and productivity.

For us, that is “Sensor Intelligence.”

## WORLDWIDE PRESENCE:

Contacts and other locations –[www.sick.com](http://www.sick.com)