

1. PART NO. EXPRESSION :

C 1 H Q - 1 N 0 S - □□
 (a) (b) (c) (d) (e)

(a) Series code

(b) Category Code

(c) Inductance code : 1N0 = 1.0nH

(d) Inductance Tolerance : S=±0.3nH , J=±5% , K=±10%

(e) 10: Standard

11 ~ 99 : Internal control number

2. CONFIGURATION & DIMENSIONS :

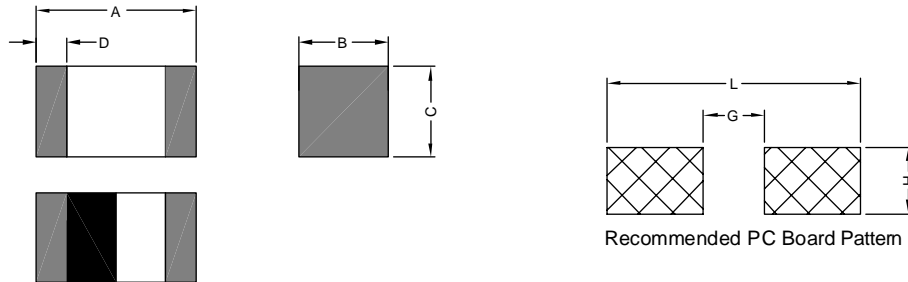

Unit:m/m

A	B	C	D	L	G	H
1.00±0.05	0.60±0.10	0.50±0.05	0.175±0.075	1.55 Ref.	0.50-0.55	0.60-0.70

3. SCHEMATIC :

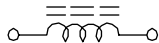

4. MATERIALS :

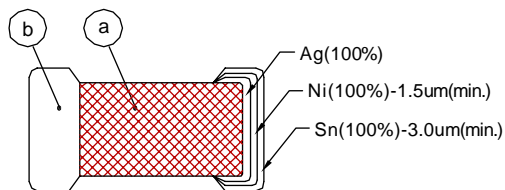

(a) Body : ceramic (Pb Free)

(b) Termination : (Pb Free)

5. GENERAL SPECIFICATION :

- a) Operating temp. : -40° C to +105° C (including self-temperature. rise)
- b) Storage condition (component in its packaging)
 - i) Temperature : -10 to 40° C
 - ii) Humidity : 60%



RoHS Compliant

NOTE : Specifications subject to change without notice. Please check our website for latest information.

28.01.2015

6. ELECTRICAL CHARACTERISTICS :

Part Number	Inductance (nH)	Test Frequency (MHz)	Q Min	Q(Typ.) Frequency(MHz)					Rated Current (mA) Max	DC Resistance (Ω)		SRF (MHz)	
				300	800	900	1500	1800		Typ.	Max.	Typ.	Min.
C1HQ-1N0S-10	1.0	100	8	53	129	147	217	244	710	0.014	0.07	>13000	10000
C1HQ-1N2S-10	1.2	100	8	45	97	110	156	177	710	0.016	0.07	>13000	10000
C1HQ-1N5S-10	1.5	100	8	35	69	76	104	116	710	0.030	0.07	>13000	8000
C1HQ-1N8S-10	1.8	100	8	32	61	66	92	100	710	0.035	0.07	11000	6000
C1HQ-2N0S-10	2.0	100	8	38	68	73	94	103	660	0.035	0.08	10500	6000
C1HQ-2N2S-10	2.2	100	8	37	67	71	92	101	660	0.040	0.08	10000	6000
C1HQ-2N4S-10	2.4	100	8	34	54	59	74	86	630	0.050	0.09	9600	6000
C1HQ-2N7S-10	2.7	100	8	30	49	52	67	73	630	0.060	0.09	9200	6000
C1HQ-3N0S-10	3.0	100	8	31	51	54	70	76	570	0.070	0.11	8700	6000
C1HQ-3N3S-10	3.3	100	8	32	54	57	72	79	540	0.075	0.12	8300	6000
C1HQ-3N6S-10	3.6	100	8	33	53	56	71	77	500	0.080	0.14	7800	5000
C1HQ-3N9S-10	3.9	100	8	34	53	56	70	76	490	0.085	0.15	7300	4000
C1HQ-4N3S-10	4.3	100	8	29	47	50	64	71	470	0.090	0.16	6900	4000
C1HQ-4N7S-10	4.7	100	8	30	48	51	65	72	450	0.095	0.17	6400	4000
C1HQ-5N1S-10	5.1	100	8	30	48	51	64	71	430	0.110	0.19	6300	4000
C1HQ-5N6S-10	5.6	100	8	30	48	51	65	71	420	0.120	0.20	6200	4000
C1HQ-6N2S-10	6.2	100	8	31	49	52	66	72	400	0.130	0.22	6100	3900
C1HQ-6N8S-10	6.8	100	8	28	44	49	59	64	390	0.130	0.23	6000	3900
C1HQ-7N5S-10	7.5	100	8	28	45	50	60	65	370	0.135	0.25	5500	3700
C1HQ-8N2S-10	8.2	100	8	29	46	50	62	66	360	0.140	0.27	5000	3600
C1HQ-9N1S-10	9.1	100	8	29	45	49	59	62	350	0.150	0.29	4800	3400
C1HQ-10NS-10	10	100	8	28	45	48	57	60	330	0.165	0.31	4500	3200
C1HQ-12NS-10	12	100	8	26	40	45	51	52	300	0.165	0.39	4300	2700
C1HQ-15NS-10	15	100	8	25	38	42	49	51	280	0.190	0.45	4100	2300

Inductance Tolerance : S=± 0.3nH , J=± 5% , K=± 10%



RoHS Compliant

NOTE : Specifications subject to change without notice. Please check our website for latest information.

28.01.2015



SUPERWORLD ELECTRONICS (S) PTE LTD

7. CHARACTERISTICS CURVES :

Impedance v.s. Frequency Characteristics

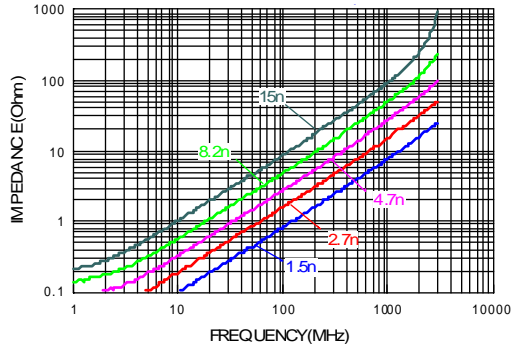

Inductance v.s. Frequency Characteristics

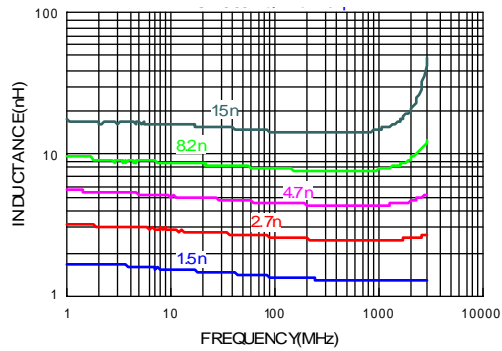

Q v.s. Frequency Characteristics

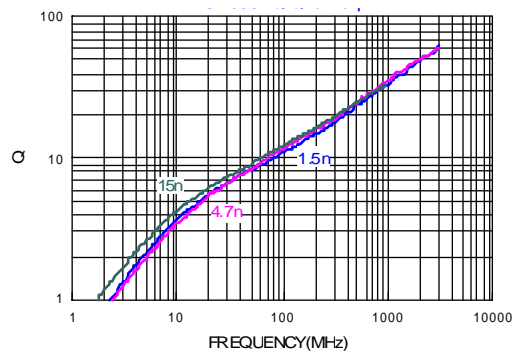

RoHS Compliant

NOTE : Specifications subject to change without notice. Please check our website for latest information.

28.01.2015



SUPERWORLD ELECTRONICS (S) PTE LTD

8. SOLDERING AND MOUNTING :

8-1. Recommended PC Board Pattern

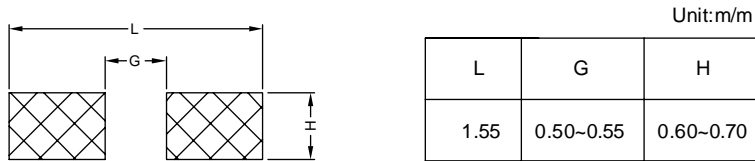

PC board should be designed so that products are not sufficient under mechanical stress as warping the board.

Products shall be positioned in the sideways direction against the mechanical stress to prevent failure.

8-2. Soldering

Mildly activated rosin fluxes are preferred. The terminations are suitable for re-flow soldering systems. If hand soldering cannot be avoided, the preferred technique is the utilization of hot air soldering tools.

Note.

If wave soldering is used ,there will be some risk.

Re-flow soldering temperatures below 240 degrees, there will be non-wetting risk

8-2.1 Lead Free Solder Re-flow :

Recommended temperature profiles for re-flow soldering in Figure 1.

8-2.2 Soldering Iron (Figure 2) :

Products attachment with soldering iron is discouraged due to the inherent process Control limitations. In the event that a soldering iron must be employed the following precautions are reCommended.

Note :

- a) Preheat circuit and products to 150° C.
- b) 350° C tip temperature (max)
- c) Never Contact the ceramic with the iron tip
- d) 1.0mm tip diameter (max)
- e) Use a 20 watt soldering iron with tip diameter of 1.0mm
- f) Limit soldering time to 4 ~ 5 secs.

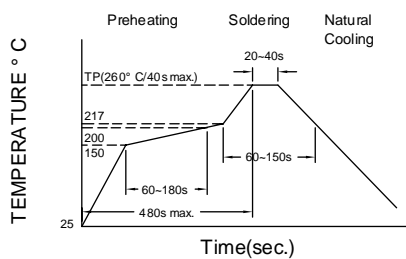

Figure 1. Re-flow Soldering : 3 times max

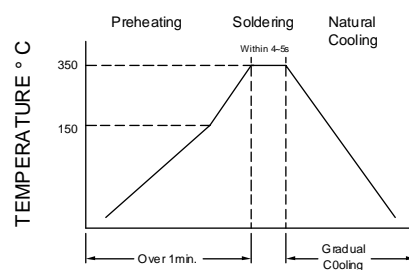

Figure 2. Hand Soldering : 1 times max



RoHS Compliant

NOTE : Specifications subject to change without notice. Please check our website for latest information.



8-3. Solder Volume

Accordingly increasing the solder volume, the mechanical stress to product is also increased. Exceeding solder volume may cause the failure of mechanical or electrical performance. Solder shall be used not to be exceed as shown in Fig. 3.

Minimum fillet height = soldering thickness + 25% product height

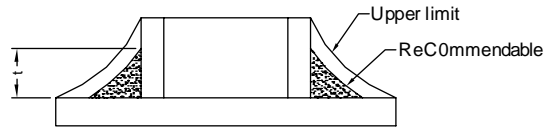

Figure 3



RoHS Compliant

NOTE : Specifications subject to change without notice. Please check our website for latest information.

28.01.2015



SUPERWORLD ELECTRONICS (S) PTE LTD

9. PACKAGING INFORMATION :

9-1. Reel Dimension

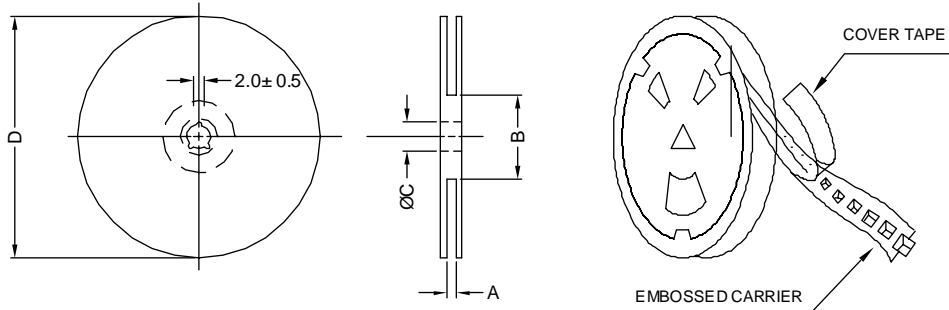

Type	A(mm)	B(mm)	C(mm)	D(mm)
7" x 8mm	10± 1.5	50 or more	13± 0.2	178.0± 2.0

9-2 Tape Dimension / 8mm

Material : Paper

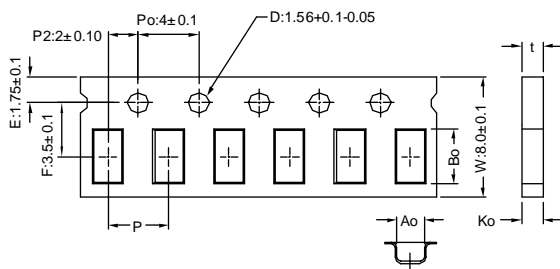

Size	Bo(mm)	Ao(mm)	Ko(mm)	P(mm)	t(mm)
C1HQ	1.15± 0.10	0.75± 0.10	0.80 max	2.0± 0.05	0.80 max

9-3. Packaging Quantity

Chip Size	C1HQ
Chip / Reel	10000
Inner Box	50000
Middle Box	250000
Carton	500000



RoHS Compliant

NOTE : Specifications subject to change without notice. Please check our website for latest information.

28.01.2015



SUPERWORLD ELECTRONICS (S) PTE LTD

9-4. Tearing Off Force

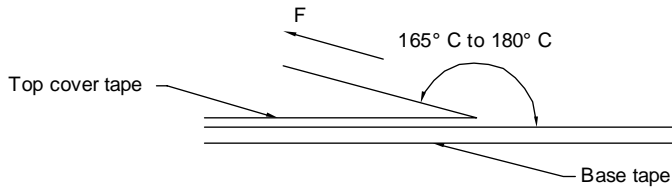

The force for tearing off cover tape is 15 to 60 grams in the arrow direction under the following conditions.

Room Temp. (° C)	Room Humidity (%)	Room atm (hPa)	Tearing Speed (mm/min)
5~35	45~85	860~1060	300

Application Notice

1. Storage Conditions :

To maintain the solderability of terminal electrodes :

- a) Recommended products should be used within 12 months from the time of delivery.
- b) The packaging material should be kept where no chlorine or sulfur exists in the air.

2. Transportation :

- a) Products should be handled with care to avoid damage or contamination from perspiration and skin oils.
- b) The use of tweezers or vacuum pick up is strongly recommended for individual components.
- c) Bulk handling should ensure that abrasion and mechanical shock are minimized.



RoHS Compliant

NOTE : Specifications subject to change without notice. Please check our website for latest information.

28.01.2015



SUPERWORLD ELECTRONICS (S) PTE LTD

PG. 7