

Wall Industries, Inc.

DCMCW60 SERIES

4:1 Ultra Wide Input Voltage Ranges
-55°C to +95°C Operating Temperature
Single Outputs, Standard Half-Brick Package
60 Watt DC/DC Power Converters



FEATURES

- Single Outputs
- 4:1 Ultra Wide Input Voltage Range: 9-36VDC and 18-75VDC
- 60 Watts Output Power
- 1500VDC I/O Isolation
- Up to 86% High Efficiency
- Lead Free Design, RoHS Compliant
- Operating Temperature Range: -55°C to +95°C (with derating)
- Remote ON/OFF
- Standard 2.40" x 2.28" x 0.5" Half-Brick Package
- Five-Sided Shielded Metal Case
- ±10% Output Trim
- Short Circuit, Over Voltage, Over Load, and Over Temperature Protection
- Custom Designs Available
- Optional Heatsink Available (Suffix "HS")

APPLICATIONS

- Distributed Power Systems
- Measurement Equipment
- Telecom
- Wireless Networks
- Industry Control Systems
- Battery Operated Equipment
- Military / Defense Applications

DESCRIPTION

The DCMCW60 series of isolated DC/DC power converters provides 60 Watts of continuous output power in a standard 2.40" x 2.28" x 0.5" half-brick package. This series consists of 5V, 12V, and 24VDC single output models with 4:1 input voltage ranges of 9-36VDC or 18~75VDC. Some features include high efficiency up to 86%, remote on/off, adjustable output voltage, 1500VDC I/O isolation, -55°C~+95°C operating temperature range (with derating), and five-sided shielding. The DCMCW60 series is RoHS compliant and has short circuit, over load, over voltage, and over temperature protection. These converters are best suited for use in battery operated equipment, measurement equipment, telecom, wireless networks, industry control systems, military/defense applications and anywhere where isolated, tightly regulated voltages and compact size are required.

TECHNICAL SPECIFICATIONS: DCMCW60 SERIES

All specifications are based on 25°C, Nominal Input Voltage, and Maximum Output Current unless otherwise noted.
We reserve the right to change specifications based on technological advances.

SPECIFICATION	TEST CONDITIONS	Min	Nom	Max	Unit
INPUT SPECIFICATIONS					
Input Voltage Range	24VDC nominal input models	9	24	36	VDC
	48VDC nominal input models	18	48	75	
Input Surge Voltage	24VDC nominal input models	100ms max.		50	VDC
	48VDC nominal input models			100	
Input Reflected Ripple Current	Nominal Vin and full load		200		mAp-p
Input Current		See Table			
Input Filter		Pi Type			
Remote ON/OFF	Converter ON	Open or $3.5V < V_r < 12V$			
	Converter: OFF	Short (to -Vin) or $0V < V_r < 1.2V$			
Sourcing Current of Remote Control Pin	Nominal Vin			0.2	mA
Idle Input Current (at Remote OFF State)	Nominal Vin			20	mA
OUTPUT SPECIFICATIONS					
Output Voltage		See Table			
Voltage Accuracy	Full load and nominal Vin	-1		+1	%
Output Current		See Table			
Output Trim	See page 4	-10		+10	%
Minimum Load		See Table			
Capacitive Load		See Table			
Start-up Time	Nominal Vin and constant resistive load		150		ms
Line Regulation	LL to HL at full load	-0.5		+0.5	%
Load Regulation	25% load to full load	-0.5		+0.5	%
Output Power		0		60	W
Ripple & Noise	5VDC & 12VDC models	20MHz Bandwidth		100	mVp-p
	15VDC models			200	
Temperature Coefficient		-0.02		+0.02	%/°C
Transient Response Overshoot	di/dt=0.8A/μs	-8		+8	% of Vo
Transient Response Settling Time	50% load step change		7.7		ms
Remote Sense		See Page 4			
PROTECTION					
Over Voltage Protection	5VDC output models	Zener Diode Clamp		6.2	VDC
	12VDC output models			15	
	24VDC output models			27	
Short Circuit Protection		Hiccup, automatic recovery			
Over Load Protection	% of full load at nominal input	110			%
Thermal Shutdown			110		°C
GENERAL SPECIFICATIONS					
Efficiency	Nominal input	See Table			
Isolation Voltage	Input to Output	1500			VDC
Isolation Resistance	500VDC	10			GΩ
Isolation Capacitance			250		pF
Switching Frequency			300		KHz
ENVIRONMENTAL SPECIFICATIONS					
Operating Temperature	With derating (see derating curve)	-55		+95	°C
Storage Temperature		-55		+125	°C
Maximum Case Temperature				+105	°C
Relative Humidity				95	% RH
Cooling	Forced air cooling		1.5m/s		
MTBF		718,000 hours			
PHYSICAL SPECIFICATIONS					
Case Material		Aluminum			
Base Material		FR4 PCB			
Potting Material		Silicon rubber (UL94V-0)			
Soldering Temperature	Lead-free wave soldering	260°C/10sec max.			
Weight		3.42oz (97g)			
Dimensions (L x W x H)		2.40 x 2.28 x 0.50 inches (61.0 x 57.9 x 12.7 mm)			

MODEL SELECTION TABLE									
Model Number	Input Voltage	Output Voltage	Output Current ⁽¹⁾		Input Current		Output Power	Efficiency ⁽²⁾	Maximum Capacitive Load
			Min Load	Full Load	No Load	Full Load			
DCMCW60-24S05	24 VDC (9 – 36 VDC)	5 VDC	50mA	12000mA	110mA	3205mA	60W	82%	1000µF
DCMCW60-24S12		12 VDC	50mA	5000mA	110mA	3086mA	60W	85%	330µF
DCMCW60-24S24		24 VDC	90mA	2500mA	110mA	3086mA	60W	85%	100µF
DCMCW60-48S05	48 VDC (18 – 75 VDC)	5 VDC	50mA	12000mA	50mA	1582mA	60W	83%	1000µF
DCMCW60-48S12		12 VDC	50mA	5000mA	50mA	1524mA	60W	86%	330µF
DCMCW60-48S24		24 VDC	90mA	2500mA	50mA	1524mA	60W	86%	100µF

NOTES

1. Output current below this value will not damage these converters; however, they may not meet all listed specifications.
2. Typical value tested at nominal input and full load.
3. For Heatsink option, add the suffix “HS” to the model number.

DERATING CURVES

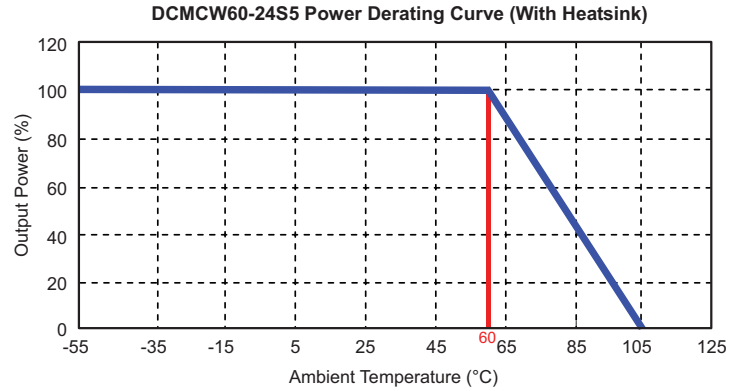
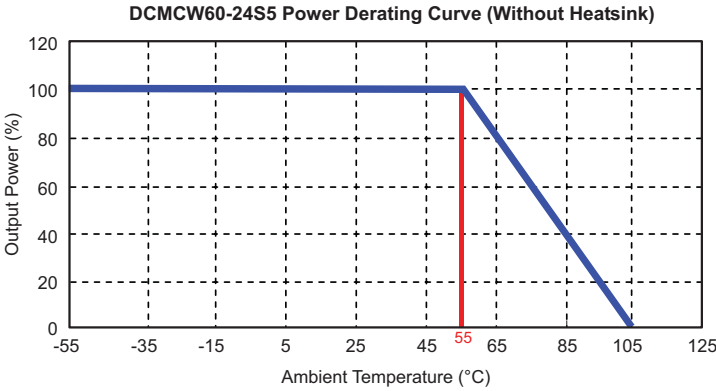

EFFICIENCY

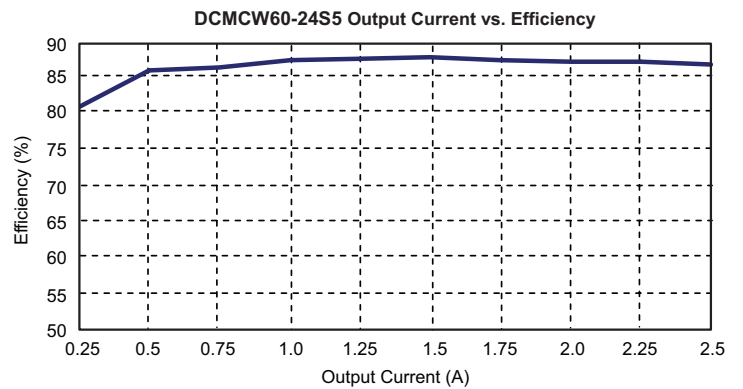
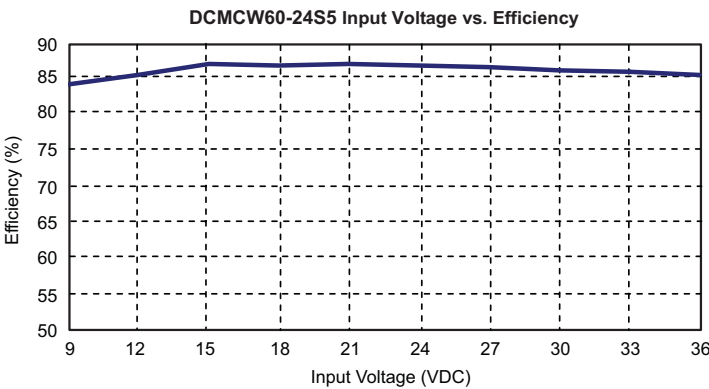

REMOTE SENSE APPLICATION CIRCUIT

The Remote Sense function is used to compensate for the voltage drop incurred when the load is located physically far away from the DC/DC converter providing its power. The remote sense pins are connected as close to the load as possible. The DC/DC converter’s regulation specifications are maintained across the points where the remote sense wires are connected at the load. This will remove the effect of the voltage drop caused by the resistance of the wires used to conduct the power from the DC/DC converter to the load. This is represented by R_{CL1} and R_{CL2} . With the use of remote sense, the effects of R_{CL1} and R_{CL2} are eliminated.

If the Remote Sense function is not used, the +Sense has to be connected to +Vout and the -Sense has to be connected to -Vout as close to the DC/DC converter as possible.

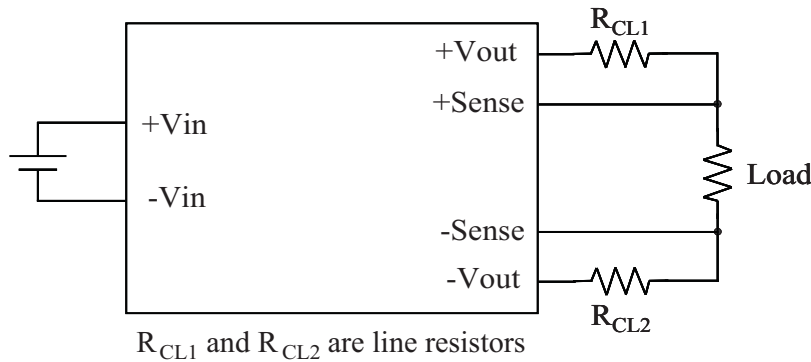

EXTERNAL OUTPUT TRIM

The output is adjustable $\pm 10\%$ of rated output voltage. To trim the output voltage up, place the trim resistor between the Trim and -Vo pins. To trim the output voltage down, place the trim resistor between the Trim and +Vo pins.

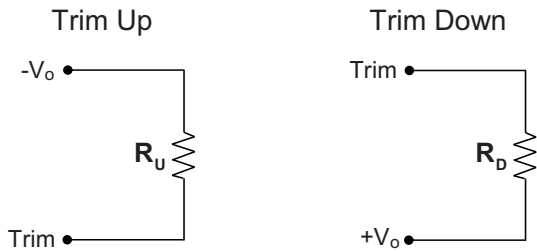

DCMCW60-XXS05 TRIM TABLE				
Trim	Trim _{up}	R _{up}	Trim _{down}	R _{down}
10%	5.5V	0.4kΩ	4.5V	0.48kΩ
7.5%	5.375V	5.175kΩ	4.625V	6.08kΩ
5%	5.25V	16.8kΩ	4.75V	17.28kΩ
2.5%	5.125V	49.59kΩ	4.875V	50.89kΩ

DCMCW60-XXS12 TRIM TABLE				
Trim	Trim _{up}	R _{up}	Trim _{down}	R _{down}
10%	13.2V	1.06kΩ	10.8V	1.19kΩ
7.5%	12.9V	6.74kΩ	11.1V	23.01kΩ
5%	12.6V	18.11kΩ	11.4V	66.64kΩ
2.5%	12.3V	52.22kΩ	11.7V	197.5kΩ

DCMCW60-XXS24 TRIM TABLE				
Trim	Trim _{up}	R _{up}	Trim _{down}	R _{down}
10%	26.4V	5.4kΩ	21.6V	0kΩ
7.5%	25.8V	13.2kΩ	22.2V	63.9kΩ
5%	25.2V	28.8kΩ	22.8V	197kΩ
2.5%	24.6V	75.6kΩ	23.4V	596kΩ

MECHANICAL DRAWINGS

Standard

Unit: inches (mm)

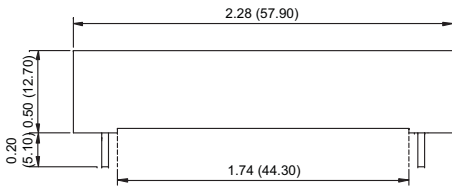
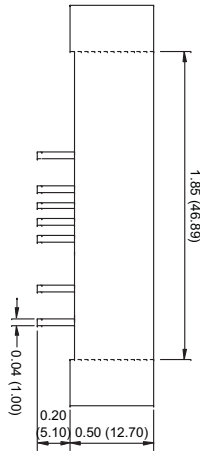
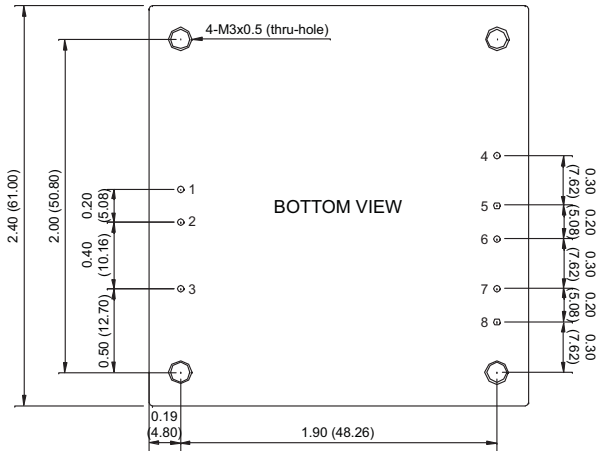

PIN CONNECTIONS	
Pin	Single
1	+Vin
2	-Vin
3	Remote ON/OFF
4	-Sense
5	+Sense
6	+Vout
7	-Vout
8	Trim

- NOTES**
1. All dimensions are for reference only
 2. Pin Diameter: 0.04 (1.0)
 3. Tolerance: ±0.02 (±0.5)

- PHYSICAL**
- Weight: 3.42oz (97g)
 - Case Material: Aluminum
 - Base Material: FR4 PCB
 - Potting Material: Silicon rubber (UL94V-0)

Heatsink Option (Suffix "HS")

Unit: inches (mm)

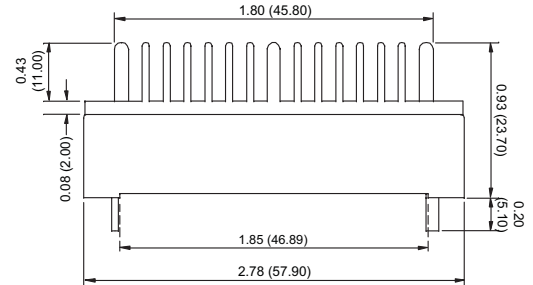
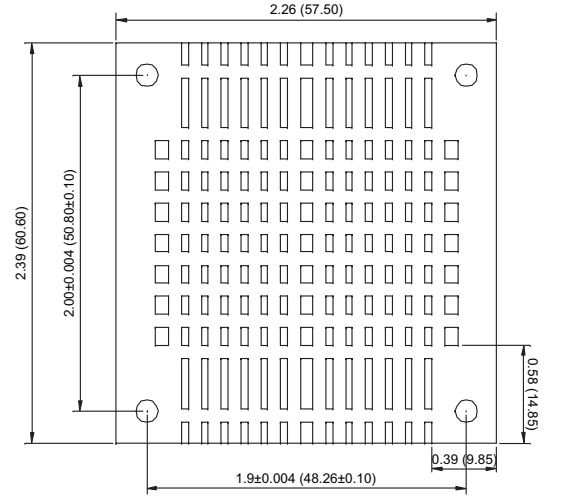

- NOTES**
1. All dimensions are for reference only
 2. Weight: 1.23oz (35g)
 3. Material: Aluminum

COMPANY INFORMATION

Wall Industries, Inc. has created custom and modified units for over 50 years. Our in-house research and development engineers will provide a solution that exceeds your performance requirements on-time and on budget. Our ISO9001-2008 certification is just one example of our commitment to producing a high quality, well-documented product for our customers.

Our past projects demonstrate our commitment to you, our customer. Wall Industries, Inc. has a reputation for working closely with its customers to ensure each solution meets or exceeds form, fit and function requirements. We will continue to provide ongoing support for your project above and beyond the design and production phases. Give us a call today to discuss your future projects.

Contact **Wall Industries** for further information:

- Phone: (603)778-2300
- Toll Free: (888)587-9255
- Fax: (603)778-9797
- E-mail: sales@wallindustries.com
- Web: www.wallindustries.com
- Address: 5 Watson Brook Rd.
Exeter, NH 03833