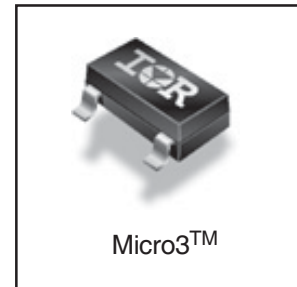
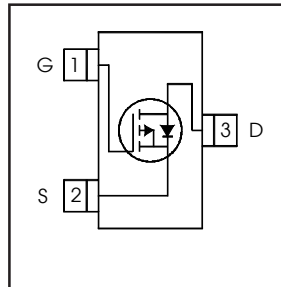


$V_{DS}$	<b>-20</b>	<b>V</b>
$R_{DS(on) max}$ (@ $V_{GS} = -4.5V$ )	<b>0.60</b>	$\Omega$
$Q_g$ (typical)	<b>2.4</b>	<b>nC</b>
$I_D$ (@ $T_A = 25^\circ C$ )	<b>-0.78</b>	<b>A</b>

HEXFET<sup>®</sup> Power MOSFET



**Features**

Industry-standard pinout SOT-23 Package
Compatible with Existing Surface Mount Techniques
RoHS Compliant, Halogen-Free
MSL1, Industrial qualification



**Benefits**

Multi-Vendor Compatibility
Easier Manufacturing
Environmentally Friendlier
Increased Reliability

Base Part Number	Package Type	Standard Pack		Orderable Part Number
		Form	Quantity	
IRLML6302TRPbF-1	Micro3™ (SOT-23)	Tape and Reel	3000	IRLML6302TRPbF-1

**Absolute Maximum Ratings**

	Parameter	Max.	Units
$I_D @ T_A = 25^\circ C$	Continuous Drain Current, $V_{GS} @ -4.5V$	-0.78	A
$I_D @ T_A = 70^\circ C$	Continuous Drain Current, $V_{GS} @ -4.5V$	-0.62	
$I_{DM}$	Pulsed Drain Current ①	-4.9	
$P_D @ T_A = 25^\circ C$	Power Dissipation	540	mW
	Linear Derating Factor	4.3	mW/°C
$V_{GS}$	Gate-to-Source Voltage	± 12	V
$dv/dt$	Peak Diode Recovery $dv/dt$ ②	-5.0	V/ns
$T_J, T_{STG}$	Junction and Storage Temperature Range	-55 to + 150	°C

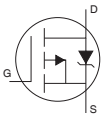
**Thermal Resistance**

	Parameter	Typ.	Max.	Units
$R_{\theta JA}$	Maximum Junction-to-Ambient ④	—	230	°C/W

**Electrical Characteristics @ T<sub>J</sub> = 25°C (unless otherwise specified)**

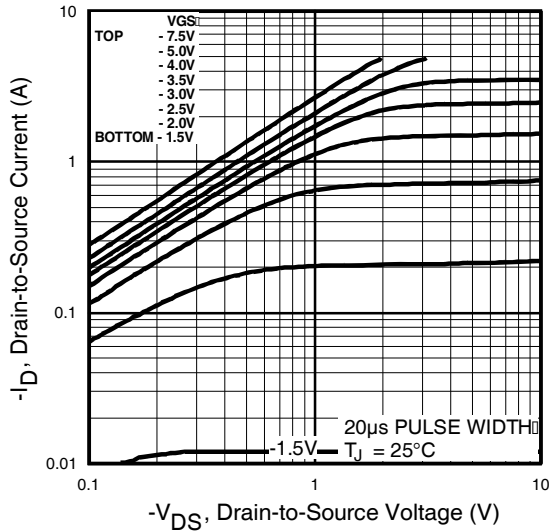
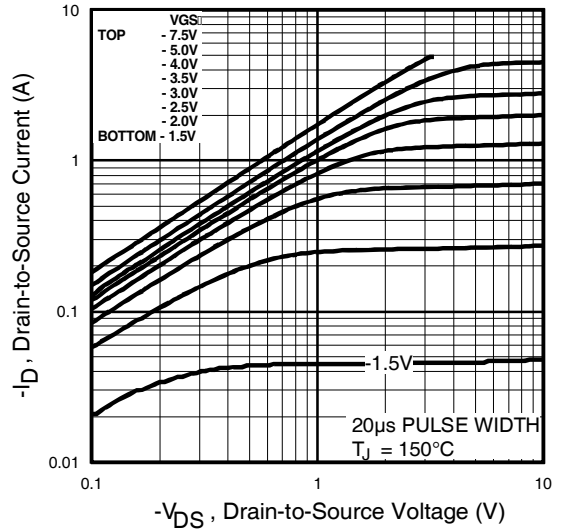
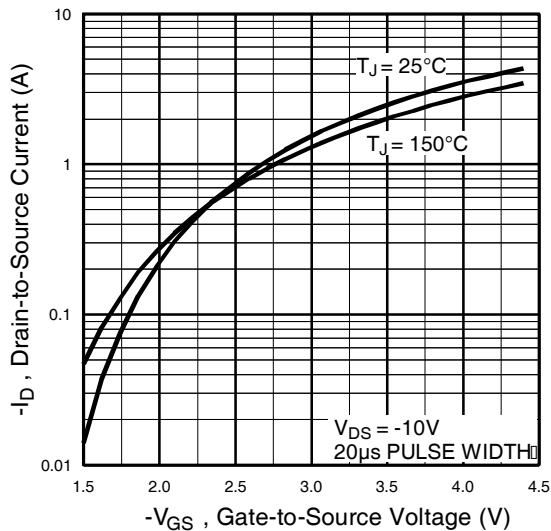
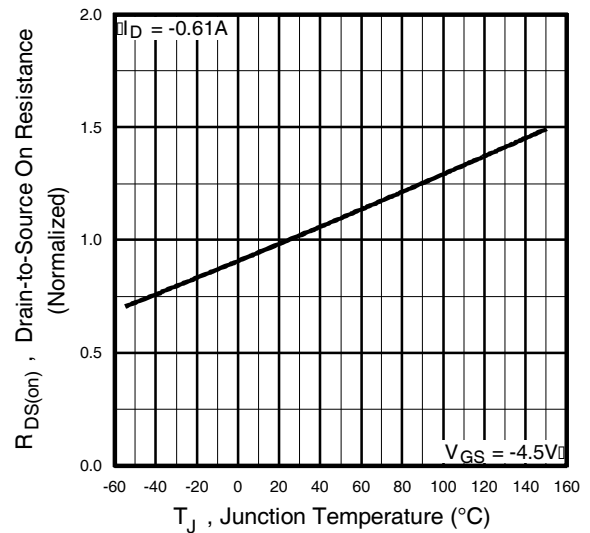
	Parameter	Min.	Typ.	Max.	Units	Conditions
V <sub>(BR)DSS</sub>	Drain-to-Source Breakdown Voltage	-20	—	—	V	V <sub>GS</sub> = 0V, I <sub>D</sub> = -250μA
ΔV <sub>(BR)DSS</sub> /ΔT <sub>J</sub>	Breakdown Voltage Temp. Coefficient	—	-4.9	—	mV/°C	Reference to 25°C, I <sub>D</sub> = -1mA
R <sub>DS(ON)</sub>	Static Drain-to-Source On-Resistance	—	—	0.60	Ω	V <sub>GS</sub> = -4.5V, I <sub>D</sub> = -0.61A ③
		—	—	0.90		V <sub>GS</sub> = -2.7V, I <sub>D</sub> = -0.31A ③
V <sub>GS(th)</sub>	Gate Threshold Voltage	-0.70	—	-1.5	V	V <sub>DS</sub> = V <sub>GS</sub> , I <sub>D</sub> = -250μA
g <sub>fs</sub>	Forward Transconductance	0.56	—	—	S	V <sub>DS</sub> = -10V, I <sub>D</sub> = -0.31A
I <sub>DSS</sub>	Drain-to-Source Leakage Current	—	—	-1.0	μA	V <sub>DS</sub> = -16V, V <sub>GS</sub> = 0V
		—	—	-25		V <sub>DS</sub> = -16V, V <sub>GS</sub> = 0V, T <sub>J</sub> = 125°C
I <sub>GSS</sub>	Gate-to-Source Forward Leakage	—	—	-100	nA	V <sub>GS</sub> = -12V
	Gate-to-Source Reverse Leakage	—	—	100		V <sub>GS</sub> = 12V
Q <sub>g</sub>	Total Gate Charge	—	2.4	3.6	nC	I <sub>D</sub> = -0.61A
Q <sub>gs</sub>	Gate-to-Source Charge	—	0.56	0.84		V <sub>DS</sub> = -16V
Q <sub>gd</sub>	Gate-to-Drain ("Miller") Charge	—	1.0	1.5		V <sub>GS</sub> = -4.5V, See Fig. 6 and 9 ③
t <sub>d(on)</sub>	Turn-On Delay Time	—	13	—	ns	V <sub>DD</sub> = -10V
t <sub>r</sub>	Rise Time	—	18	—		I <sub>D</sub> = -0.61A
t <sub>d(off)</sub>	Turn-Off Delay Time	—	22	—		R <sub>G</sub> = 6.2Ω
t <sub>f</sub>	Fall Time	—	22	—		R <sub>D</sub> = 16Ω, See Fig. 10 ③
C <sub>iss</sub>	Input Capacitance	—	97	—	pF	V <sub>GS</sub> = 0V
C <sub>oss</sub>	Output Capacitance	—	53	—		V <sub>DS</sub> = -15V
C <sub>rss</sub>	Reverse Transfer Capacitance	—	28	—		f = 1.0MHz, See Fig. 5

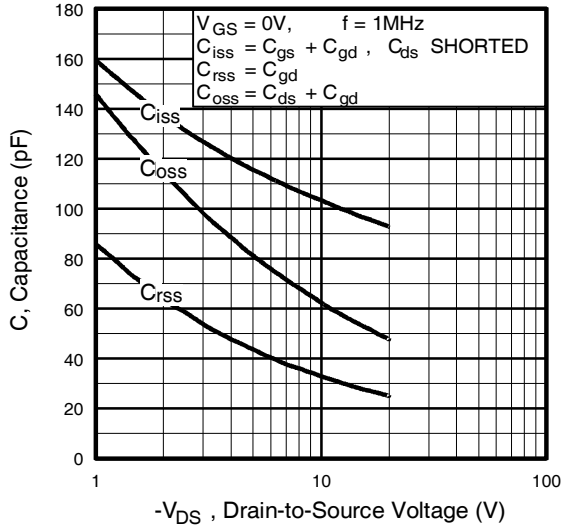
**Source-Drain Ratings and Characteristics**

	Parameter	Min.	Typ.	Max.	Units	Conditions
I <sub>S</sub>	Continuous Source Current (Body Diode)	—	—	-0.54	A	MOSFET symbol showing the integral reverse p-n junction diode. 
I <sub>SM</sub>	Pulsed Source Current (Body Diode) ①	—	—	-4.9		
V <sub>SD</sub>	Diode Forward Voltage	—	—	-1.2	V	T <sub>J</sub> = 25°C, I <sub>S</sub> = -0.61A, V <sub>GS</sub> = 0V ④
t <sub>rr</sub>	Reverse Recovery Time	—	35	53	ns	T <sub>J</sub> = 25°C, I <sub>F</sub> = -0.61A
Q <sub>rr</sub>	Reverse Recovery Charge	—	26	39	nC	di/dt = -100A/μs ④

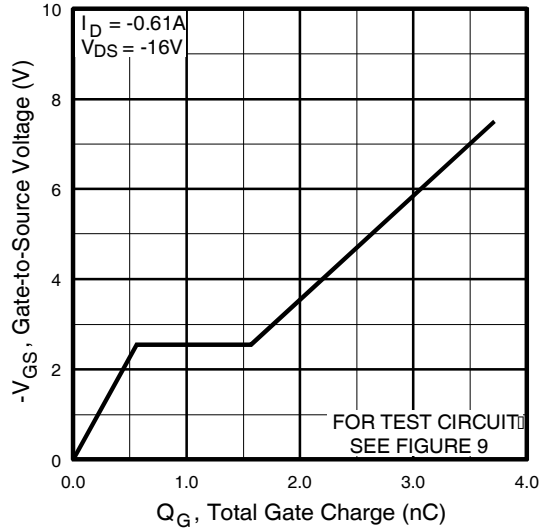
**Notes:**

- ① Repetitive rating; pulse width limited by max. junction temperature. ( See fig. 11 )
- ② I<sub>SD</sub> ≤ -0.61A, di/dt ≤ 76A/μs, V<sub>DD</sub> ≤ V<sub>(BR)DSS</sub>, T<sub>J</sub> ≤ 150°C
- ③ Pulse width ≤ 300μs; duty cycle ≤ 2%.
- ④ Surface mounted on FR-4 board, t ≤ 5sec.

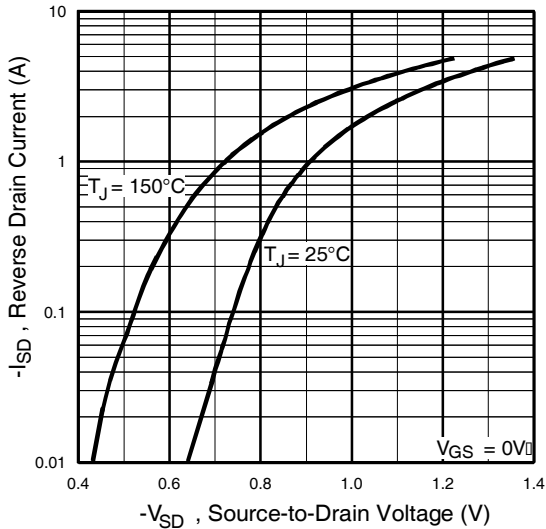

**Fig 1. Typical Output Characteristics**

**Fig 2. Typical Output Characteristics**

**Fig 3. Typical Transfer Characteristics**

**Fig 4. Normalized On-Resistance Vs. Temperature**



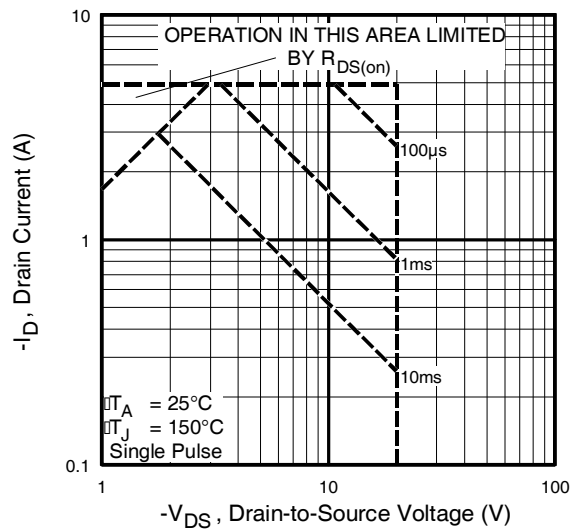
**Fig 5.** Typical Capacitance Vs. Drain-to-Source Voltage



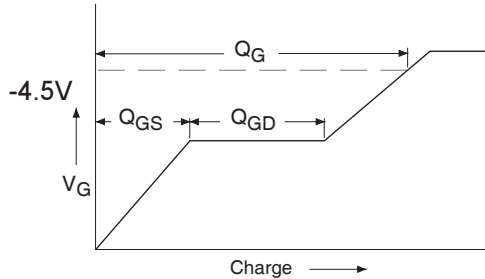
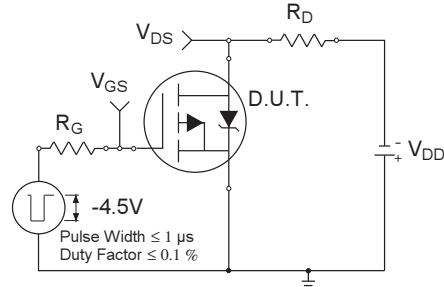
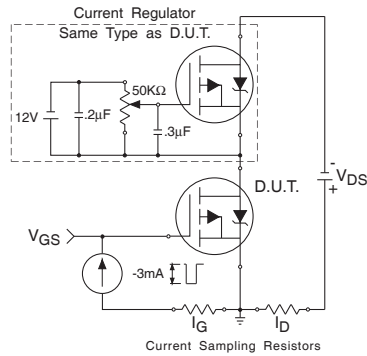
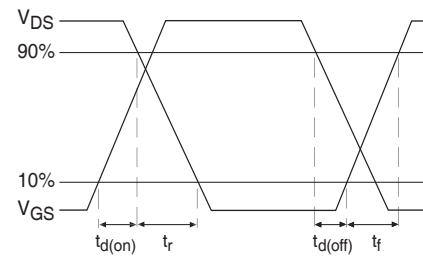
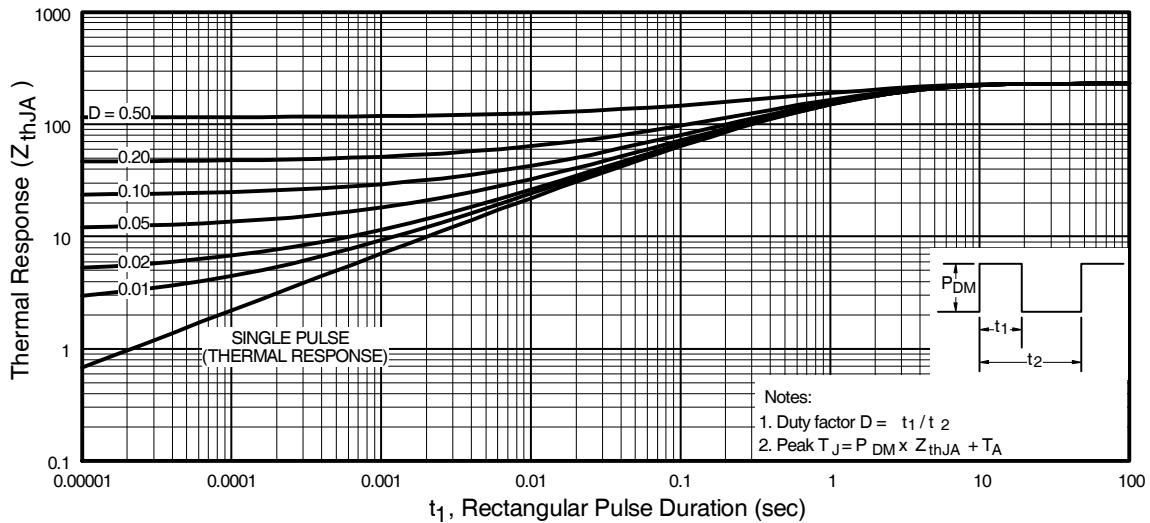
**Fig 6.** Typical Gate Charge Vs. Gate-to-Source Voltage

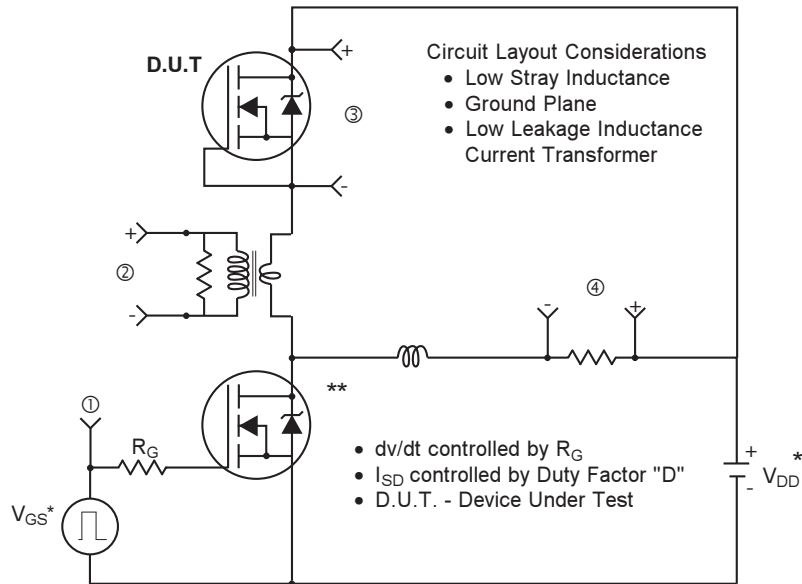


**Fig 7.** Typical Source-Drain Diode Forward Voltage



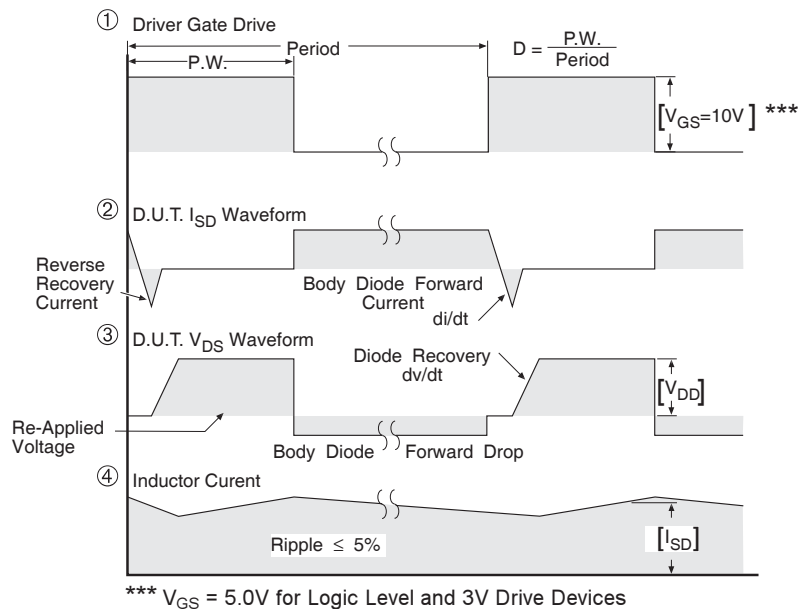
**Fig 8.** Maximum Safe Operating Area


**Fig 9a. Basic Gate Charge Waveform**

**Fig 10a. Switching Time Test Circuit**

**Fig 9b. Gate Charge Test Circuit**

**Fig 10b. Switching Time Waveforms**

**Fig 11. Maximum Effective Transient Thermal Impedance, Junction-to-Ambient**

**Peak Diode Recovery dv/dt Test Circuit**


\* Reverse Polarity for P-Channel

\*\* Use P-Channel Driver for P-Channel Measurements

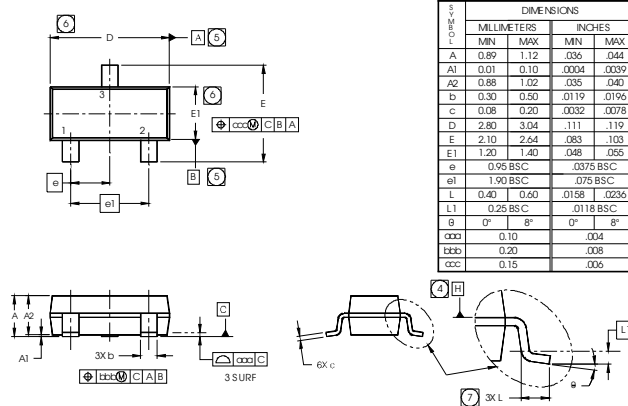


**Fig 13. For P-Channel HEXFETS**



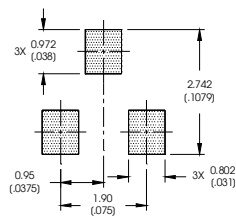
### Micro3 (SOT-23) (Lead-Free) Package Outline

Dimensions are shown in millimeters (inches)



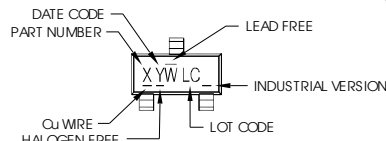
DIMENSIONS	DIMENSIONS			
	MILLIMETERS		INCHES	
	MIN	MAX	MIN	MAX
A	0.89	1.12	.036	.044
A1	0.01	0.10	.0004	.0039
A2	0.88	1.02	.035	.040
b	0.30	0.50	.0119	.0196
c	0.08	0.20	.0032	.0078
D	2.90	3.04	.111	.119
E	2.10	2.64	.083	.103
E1	1.20	1.40	.048	.055
e	0.95 BSC		.0375 BSC	
e1	1.90 BSC		.075 BSC	
L	0.40	0.60	.0158	.0236
L1	0.25 BSC		.0118 BSC	
g	0°	8°	0°	8°
ddd	0.10		.004	
bbb	0.20		.008	
ccc	0.15		.006	

RECOMMENDED FOOTPRINT



- NOTES
1. DIMENSIONING AND TOLERANCING PER ASME Y14.5M-1994.
  2. DIMENSIONS ARE SHOWN IN MILLIMETERS AND INCHES.
  3. CONTROLLING DIMENSION: MILLIMETER.
  4. DATUM PLANE H IS LOCATED AT THE MOLD PARTING LINE.
  5. DATUM A AND B TO BE DETERMINED AT DATUM PLANE H.
  6. DIMENSIONS D AND E1 ARE MEASURED AT DATUM PLANE H.
  7. DIMENSION L IS THE LEAD LENGTH FOR SOLDERING TO A SUBSTRATE.
  8. OUTLINE CONFORMS TO JEDEC OUTLINE TO 236AB.

### Micro3 (SOT-23 / TO-236AB) Part Marking Information



X = PART NUMBER CODE REFERENCE:

- |               |               |
|---------------|---------------|
| A = IRLML2402 | S = IRLML6244 |
| B = IRLML2803 | T = IRLML6246 |
| C = IRLML6302 | U = IRLML6344 |
| D = IRLML5103 | V = IRLML6346 |
| E = IRLML6402 | W = IRFML8244 |
| F = IRLML6401 | X = IRLML2244 |
| G = IRLML2502 | Y = IRLML2246 |
| H = IRLML5203 | Z = IRFML9244 |
| I = IRLML0030 |               |
| J = IRLML2030 |               |
| K = IRLML0100 |               |
| L = IRLML0060 |               |
| M = IRLML0040 |               |
| N = IRLML2060 |               |
| P = IRLML9301 |               |
| R = IRLML9303 |               |

Note: A line above the work week (as shown here) indicates Lead-Free.

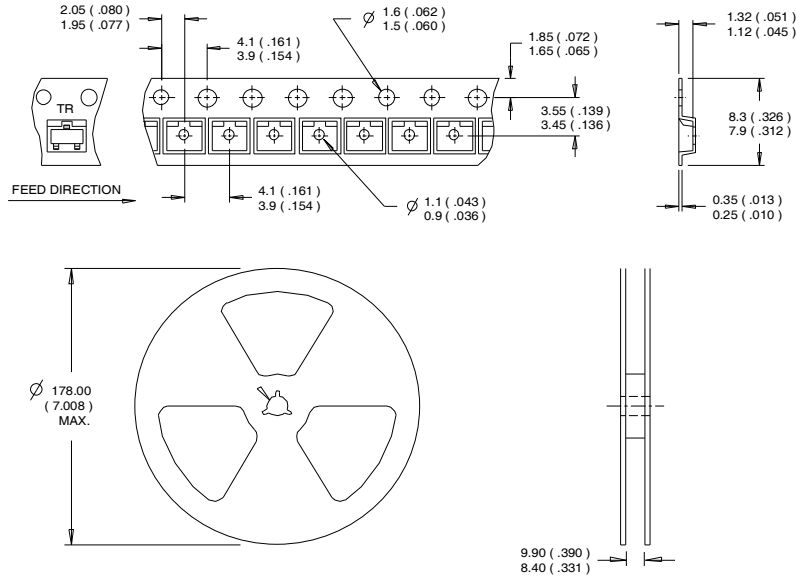
W = (1-26) IF PRECEDED BY LAST DIGIT OF CALENDAR YEAR

YEAR	Y	WORK WEEK	W	
2011	2001	1	01	A
2012	2002	2	02	B
2013	2003	3	03	C
2014	2004	4	04	D
2015	2005	5		
2016	2006	6		
2017	2007	7		
2018	2008	8		
2019	2009	9		
2020	2010	0	24	X
			25	Y
			26	Z

W = (27-52) IF PRECEDED BY A LETTER

YEAR	Y	WORK WEEK	W	
2011	2001	A	27	A
2012	2002	B	28	B
2013	2003	C	29	C
2014	2004	D	30	D
2015	2005	E		
2016	2006	F		
2017	2007	G		
2018	2008	H		
2019	2009	J		
2020	2010	K	50	X
			51	Y
			52	Z

Note: For the most current drawing please refer to IR website at <http://www.irf.com/package/>

**Micro3™ Tape & Reel Information** (Dimensions are shown in millimeters (inches))


NOTES:  
 1. CONTROLLING DIMENSION : MILLIMETER.  
 2. OUTLINE CONFORMS TO EIA-481 & EIA-541.

**Note:** For the most current drawing please refer to IR website at <http://www.irf.com/package/>

**Qualification information†**

Qualification level	Industriid (per JEDEC JESD47F <sup>††</sup> guidelines)	
Moisture Sensitivity Level	Micro3™ (SOT-23)	M5L1 (per JEDEC J-STD-020D <sup>††</sup> )
RoHS compliant	Yes	

† Qualification standards can be found at International Rectifier's web site: <http://www.irf.com/product-info/reliability>

†† Applicable version of JEDEC standard at the time of product release

**Revision History**

Date	Comment
10/28/2014	• Updated partmarking to reflect Industrial partmarking on page 7.

International  
 Rectifier

**IR WORLD HEADQUARTERS:** 101 N. Sepulveda Blvd., El Segundo, California 90245, USA  
 To contact International Rectifier, please visit <http://www.irf.com/whoto-call/>