



ON Semiconductor®

<http://onsemi.com>

LA59700MC

Monolithic Linear IC

Adjustable Voltage Type Regulator

Overview

LA59700MC is an adjustable voltage regulator which has chip enable function.
The maximum current of 1.0A can be output.

Features

- Adjustable output voltage
- Maximum output current: 1.0A
- Chip enable function
- Build-in over current protection circuit
- Available ceramic capacitors

Specifications

Maximum Ratings at $T_a = 25^\circ\text{C}$

Parameter	Symbol	Conditions	Ratings	Unit
Maximum supply voltage	$V_{CC \text{ max}}$		16	V
Maximum input voltage	$V_{IN \text{ max}}$		16	V
Allowable power dissipation	$P_d \text{ max}$	Mounted on a specified board *1	1.8	W
Operating temperature	T_{opr}		-40 to +85	$^\circ\text{C}$
Storage temperature	T_{stg}		-55 to +150	$^\circ\text{C}$

*1. Specified board: 50mm × 50mm × 1.6mm, glass epoxy double side board.

Stresses exceeding Maximum Ratings may damage the device. Maximum Ratings are stress ratings only. Functional operation above the Recommended Operating Conditions is not implied. Extended exposure to stresses above the Recommended Operating Conditions may affect device reliability.

LA59700MC

Recommended Operating Conditions at $T_a = 25^\circ\text{C}$

Parameter	Symbol	Conditions	Ratings	Unit
Input voltage (V_{CC1})	V_{CC1}		3.5 to 15	V
Input voltage (V_{CC2})	V_{CC2}		*2 ($V_{OUT}+V_{DROP}$) to 15	V
Input voltage (EN)	V_{EN}		0 to 15	V
Output voltage	V_{OUT}		1.5 to ($V_{CC1}-1.5$)	V

*2. V_{DROP} : Dropout voltage

Electrical Characteristics at $T_a = 25^\circ\text{C}$, $V_{CC1} = V_{CC2} = 3.5\text{V}$, $V_{EN} = 1.6\text{V}$, $V_{OUT} = 1.5\text{V}$

Parameter	Symbol	Conditions	Ratings			Unit
			min	typ	max	
Supply current	I_{CC}	$V_{EN} = 1.6\text{V}$		3.5	7	mA
Standby current	I_{STBY}	$V_{EN} = 0\text{V}$			1	μA
Output voltage	V_{OUT}	OUT = ADJ, $I_{OUT} = 10\text{mA}$	1.225	1.25	1.275	V
Output current	I_{OUT}		1.0			A
Dropout voltage ($V_{CC2}-V_{OUT}$)	V_{DROP}	$I_{OUT} = 500\text{mA}$		0.42	0.6	V
		$I_{OUT} = 1.0\text{A}$		0.84	1.2	V
ADJ source current	I_{ADJ}	ADJ = 0V, OUT = Open		160	300	nA
Load regulation	R_{LD}	$I_{OUT} = 10\text{mA}$ to 500mA			10	mV
Line regulation	R_{LN}	$V_{CC1} = V_{CC2} = 3.5\text{V}$ to 7V , $I_{OUT} = 10\text{mA}$			10	mV
Output voltage temperature coefficient *3	$\Delta V / \Delta T$	$T_a = -40$ to $+85^\circ\text{C}$, $I_{OUT} = 10\text{mA}$		± 100		ppm/ $^\circ\text{C}$
Ripple rejection *3	R_{RR}	$V_{CC1} = V_{CC2} = 4.25\text{V}$, OUT = ADJ, $I_{OUT} = 10\text{mA}$, $V_{Rpp} = 1\text{V}$, $f_{RR} = 120\text{Hz}$, $C_{OUT} = \text{Ceramic } 10\mu\text{F}$		65		dB
Chip enable voltage	V_{EN}		1.6			V
Disable voltage	V_{DIS}				0.4	V
EN input current	I_{EN}	$V_{EN} = 1.6\text{V}$		50		μA
Thermal shutdown temperature *3	T_{TSD}	Junction temperature		170		$^\circ\text{C}$
TSD hysteresis *3	T_{HYS}			30		$^\circ\text{C}$

*3. Design guarantee value, Do not measurement.

Package Dimensions

unit : mm (typ)

3439

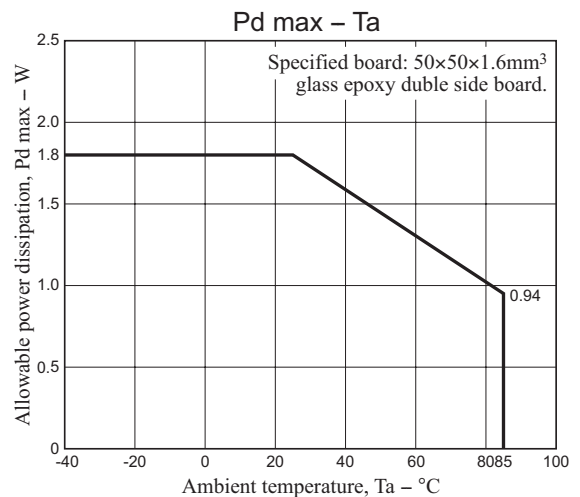
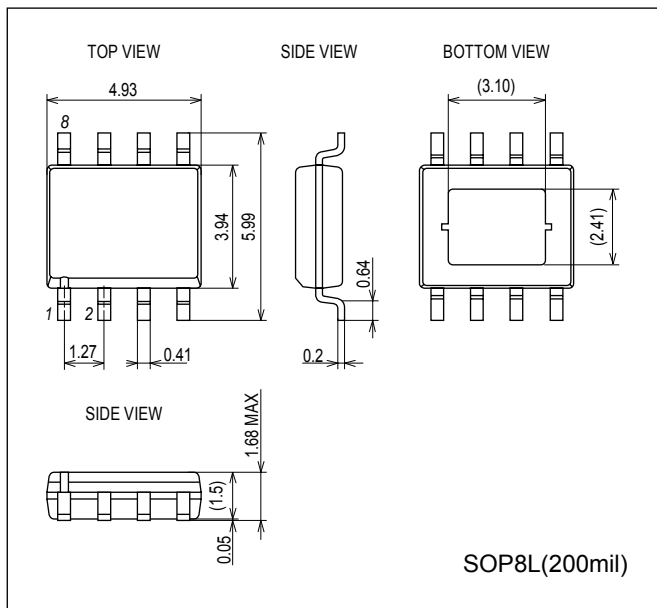

LA59700MC

<<front>>

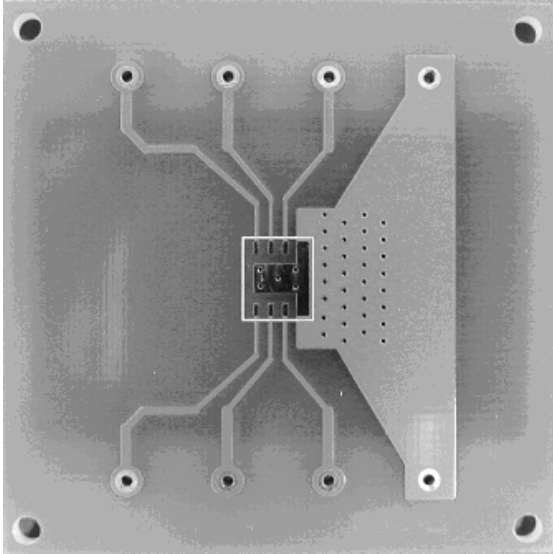

<<back>>

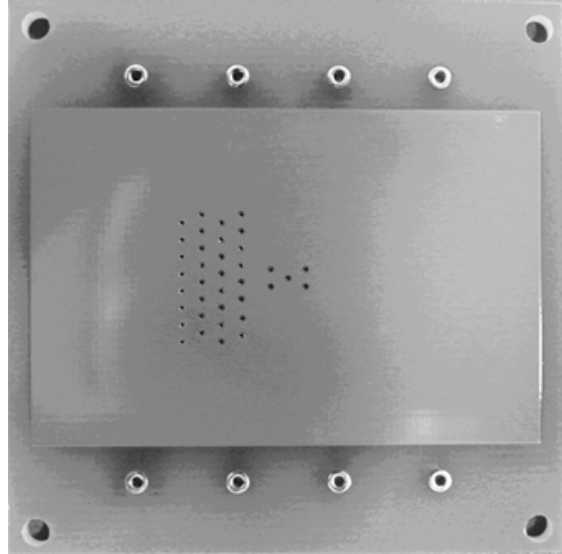

Specification of evaluation board: 50mm × 50mm × 1.6mm, glass epoxy, double side board

Pin Assignment

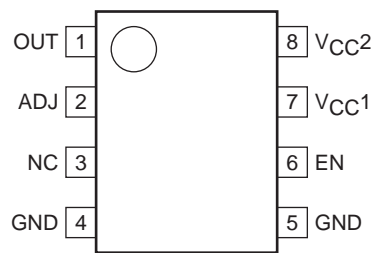

Top view

Block Diagram and Application Circuit Example

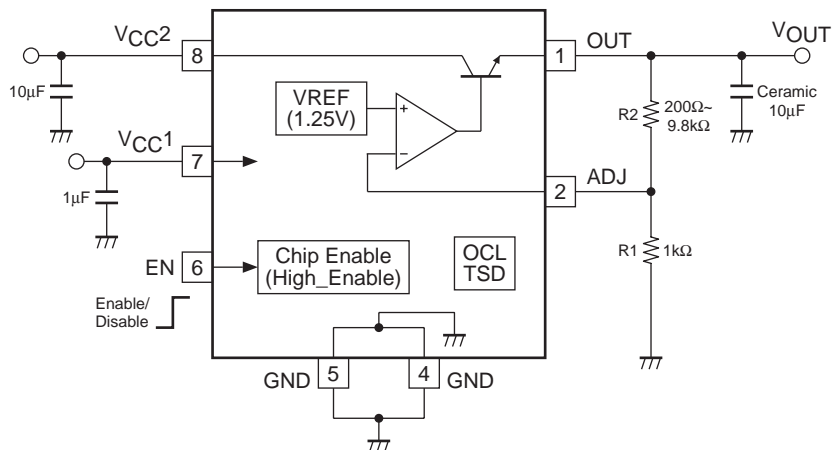

LA59700MC

Formula of Output Voltage Adjustment

$$V_{OUT} = V_{ADJ} (\approx 1.25V) \times (R1+R2)/R1$$

Note: Set the resistance of R1 and R2 so that a large enough current flows through the two resistors, making the effect on the source current from the ADJ pin negligible.

Startup Method

This IC can be started in one of the following two ways:

- (1) Start the IC by turning on and off the EN pin after applying power to VCC1 and VCC2.
- (2) Short circuit the VCC1, VCC2, and EN pins.

When using method (1), apply power to VCC1 and VCC2 simultaneously, or in the order of VCC1 to VCC2, then to the EN pin.

To shutdown the IC, follow the start-up procedure in reverse order.

Pin Function

Pin No.	Pin name	Function	Equivalent circuit
1	OUT	Output.	
2	ADJ	Adjustable input.	
3	NC	No connection.	
4	GND	Ground. Connect to Pin 5 internally.	
5	GND	Ground. Connect to Pin 4 internally.	
6	EN	Chip Enable. (High Enable)	
7	VCC1	Analog power supply.	
8	VCC2	Output power supply.	

*4 When you use this IC, Please short-circuit Exposed-Pad and GND-pin on the IC mounting side.

LA59700MC

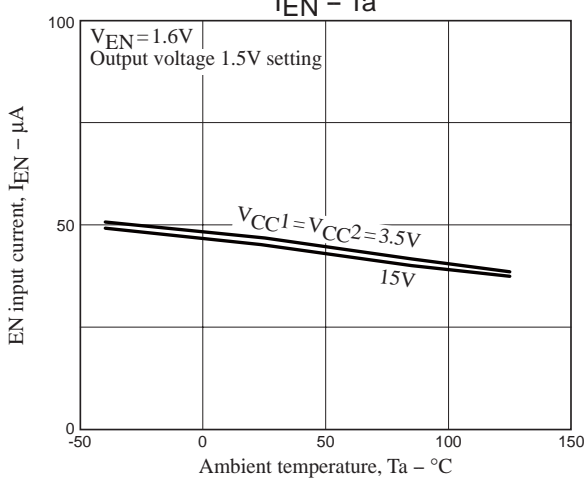
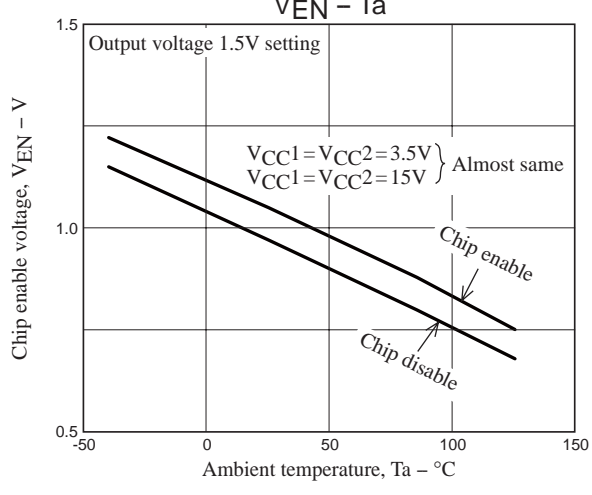
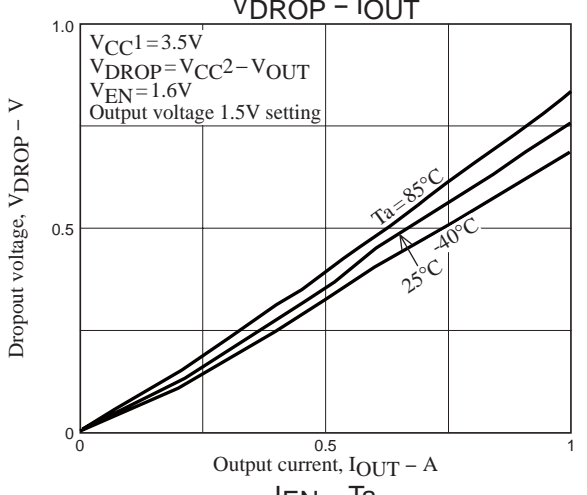
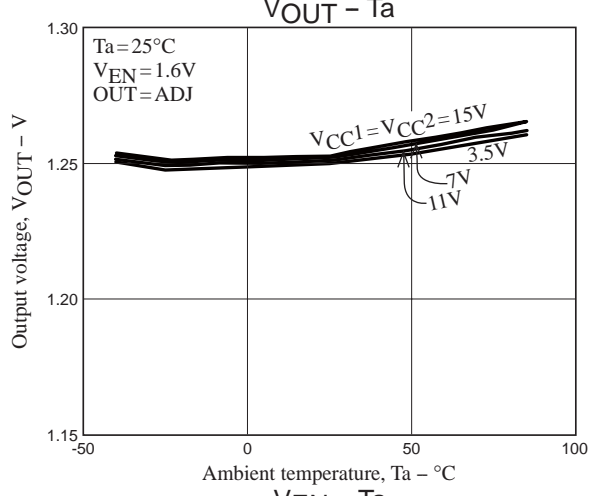
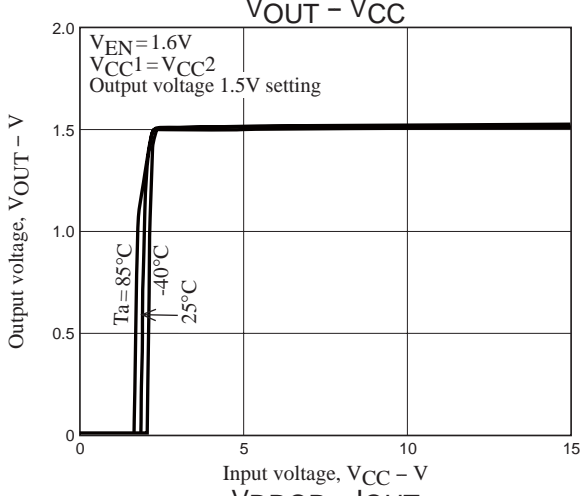
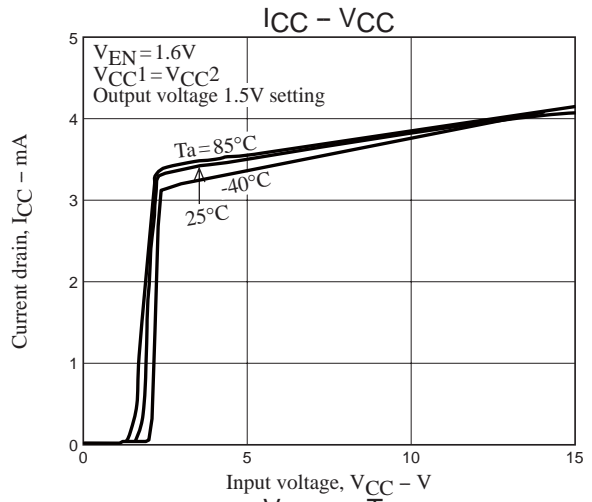
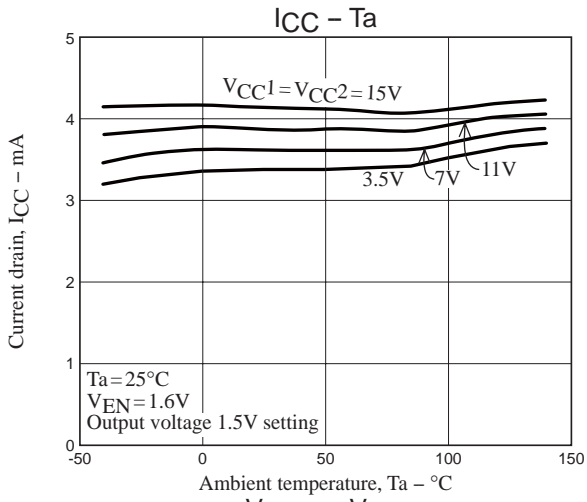

LA59700MC

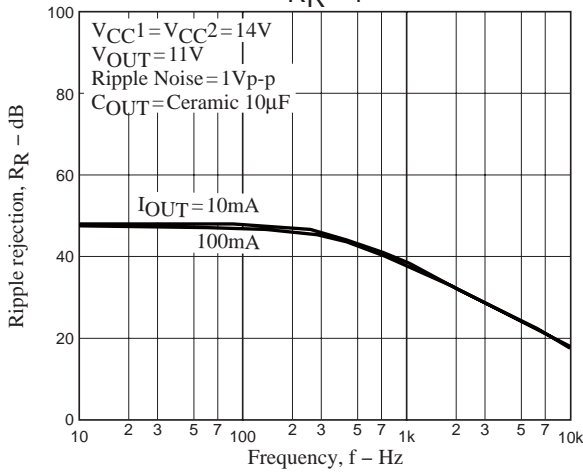
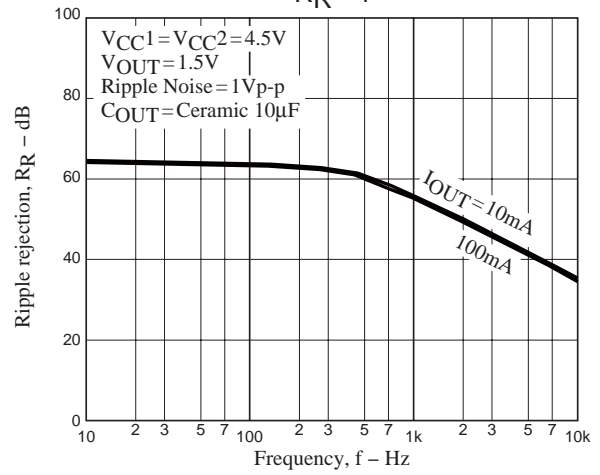
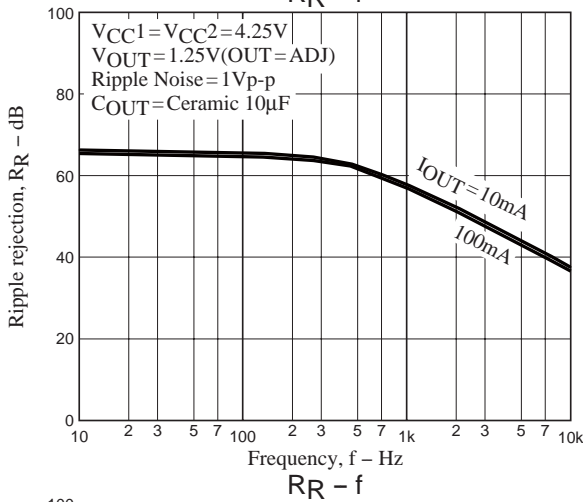
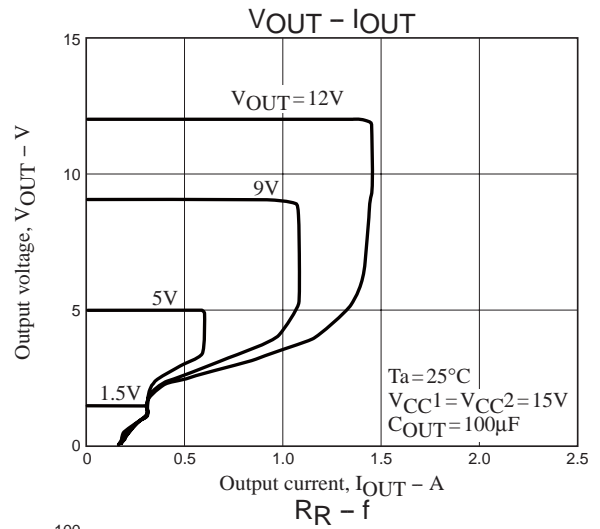
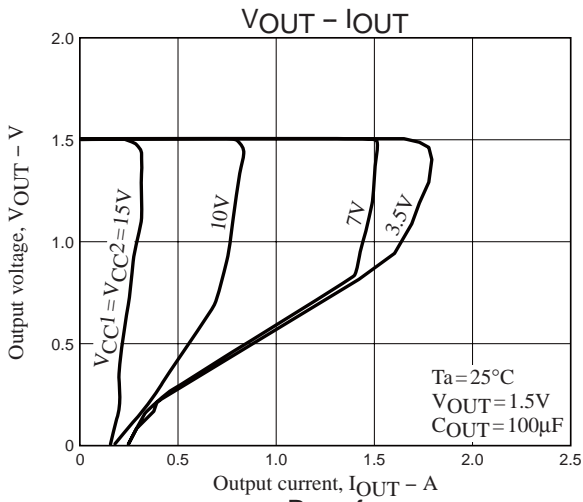

V_{OUT} Startup Characteristic

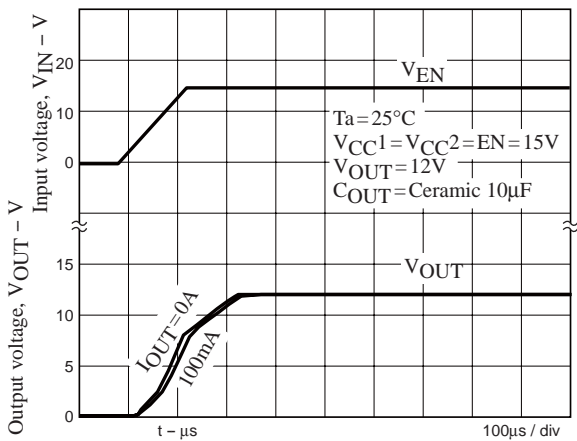
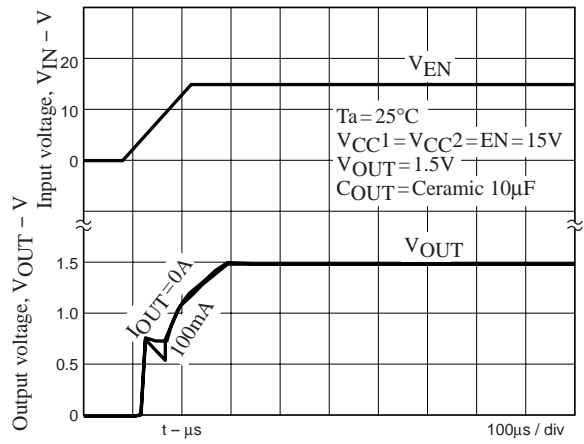
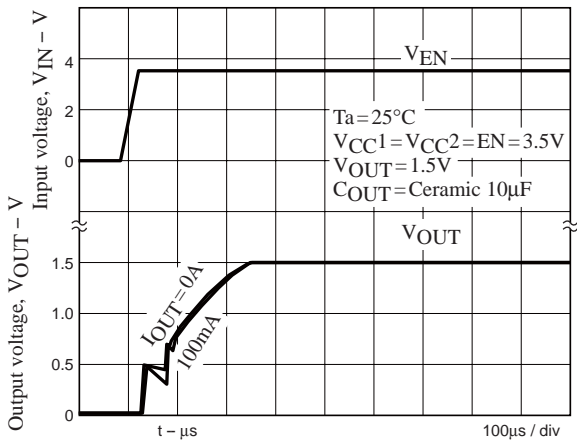
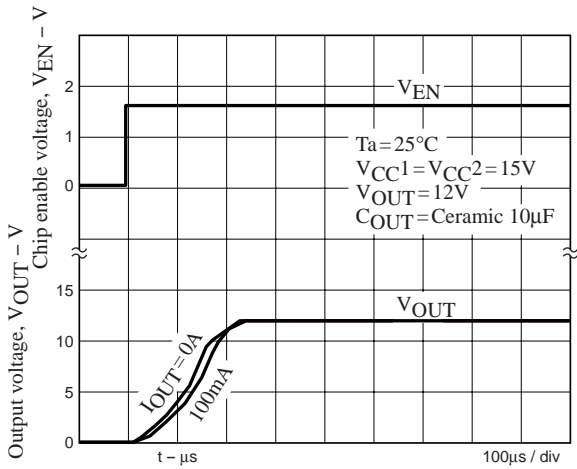
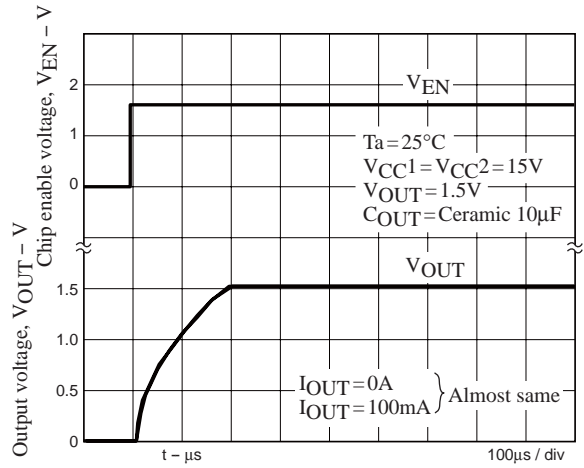
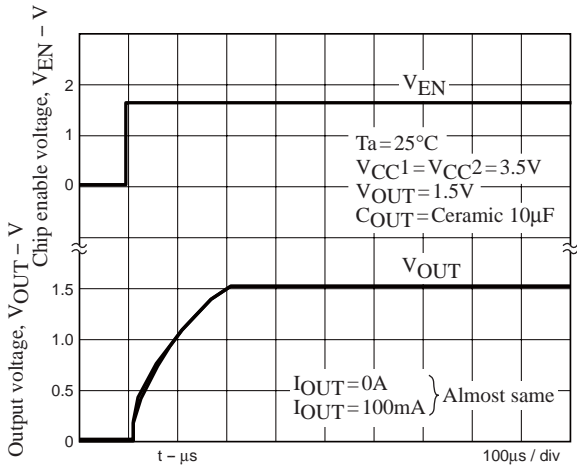

Note: The output voltage (V_{OUT}) may overshoot when V_{IN} starts up with slew rate of 0.1V/µs or over.

Load Transient Response Characteristics

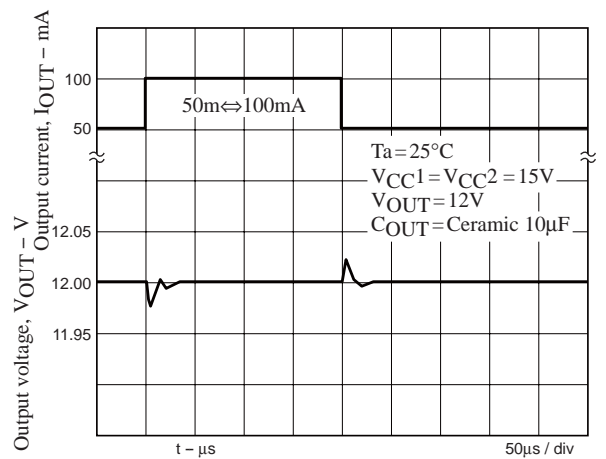
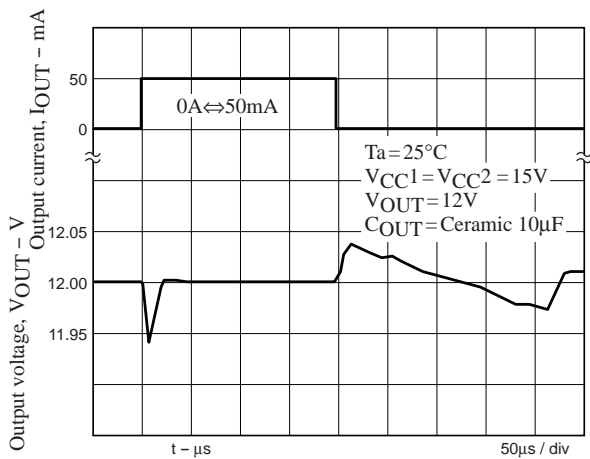
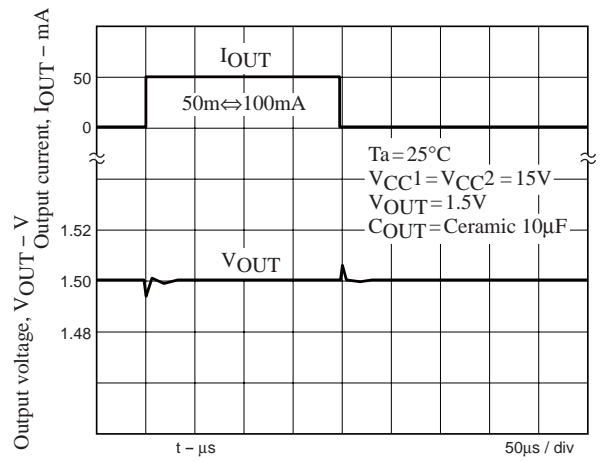
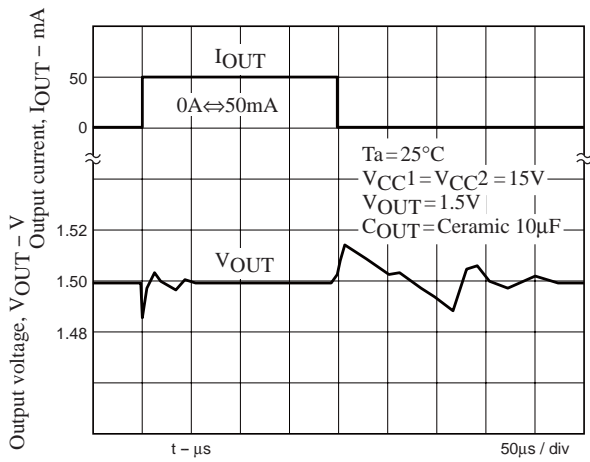
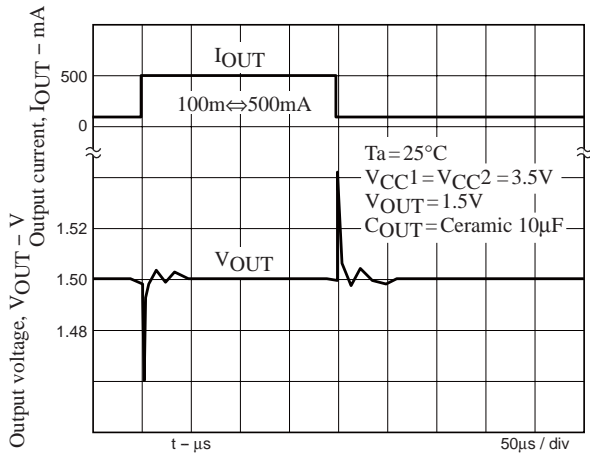
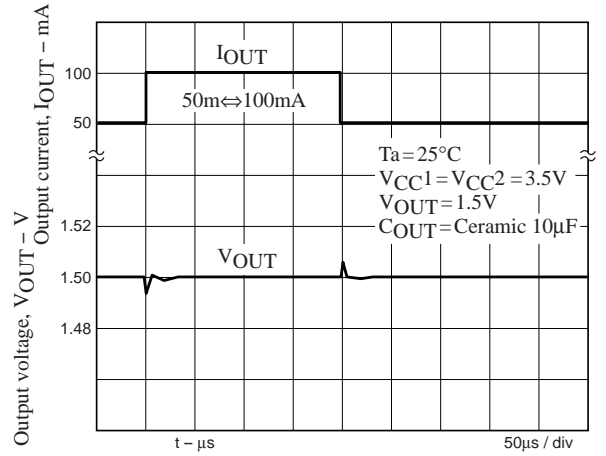
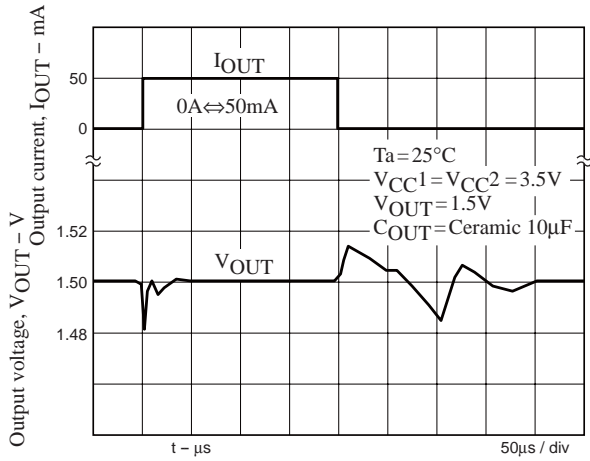

LA59700MC

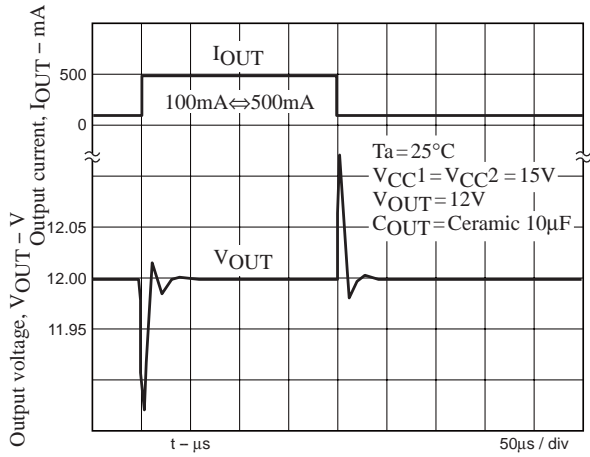

ON Semiconductor and the ON logo are registered trademarks of Semiconductor Components Industries, LLC (SCILLC). SCILLC owns the rights to a number of patents, trademarks, copyrights, trade secrets, and other intellectual property. A listing of SCILLC's product/patent coverage may be accessed at www.onsemi.com/site/pdf/Patent-Marking.pdf. SCILLC reserves the right to make changes without further notice to any products herein. SCILLC makes no warranty, representation or guarantee regarding the suitability of its products for any particular purpose, nor does SCILLC assume any liability arising out of the application or use of any product or circuit, and specifically disclaims any and all liability, including without limitation special, consequential or incidental damages. "Typical" parameters which may be provided in SCILLC data sheets and/or specifications can and do vary in different applications and actual performance may vary over time. All operating parameters, including "Typicals" must be validated for each customer application by customer's technical experts. SCILLC does not convey any license under its patent rights nor the rights of others. SCILLC products are not designed, intended, or authorized for use as components in systems intended for surgical implant into the body, or other applications intended to support or sustain life, or for any other application in which the failure of the SCILLC product could create a situation where personal injury or death may occur. Should Buyer purchase or use SCILLC products for any such unintended or unauthorized application, Buyer shall indemnify and hold SCILLC and its officers, employees, subsidiaries, affiliates, and distributors harmless against all claims, costs, damages, and expenses, and reasonable attorney fees arising out of, directly or indirectly, any claim of personal injury or death associated with such unintended or unauthorized use, even if such claim alleges that SCILLC was negligent regarding the design or manufacture of the part. SCILLC is an Equal Opportunity/Affirmative Action Employer. This literature is subject to all applicable copyright laws and is not for resale in any manner.