

LD15011A/BRG Series - 1.50 inch Single Digit 7 Segment Dual-color LED Display



ATTENTION
OBSERVE PRECAUTIONS
FOR HANDLING
ELECTROSTATIC
DISCHARGE
SENSITIVE
DEVICES



Features

- 38.10 mm (1.50 inch) digit high
- Excellent digit appearance
- Wide viewing angle
- Range of emitted colors
- I.C. compatible
- Low power consumption
- White segment, black face
- RoHS compliant

Available options

- Alternative emitting luminosity:
Standard or high brightness version
- Alternative emitted color
- Alternative face and segment color
- Alternative font
- Both CA and CC versions are available
- Cropped terminal pins

Package Dimensions

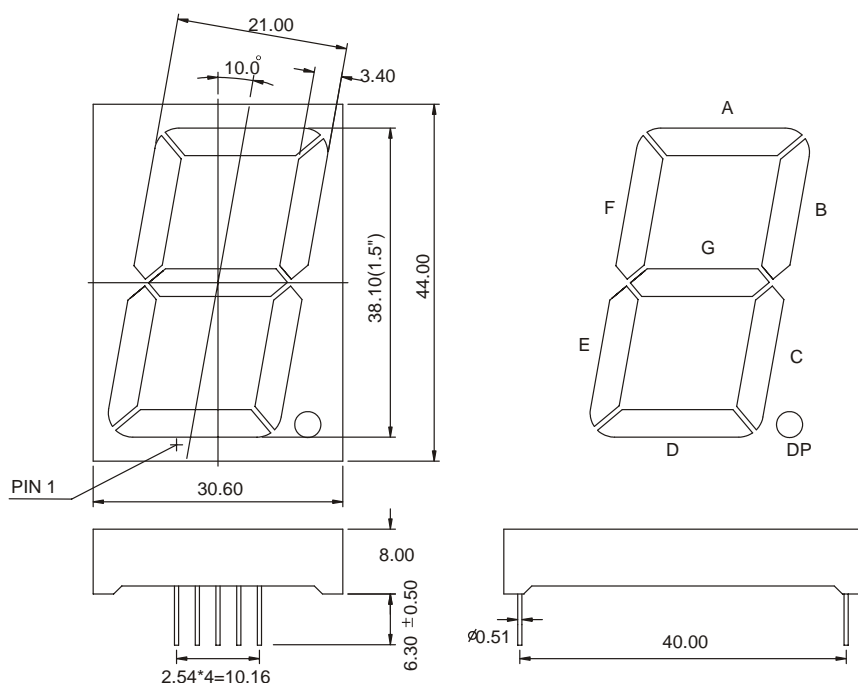

Notes:

1. All dimensions are in millimeters (inches), Tolerance is $\pm 0.25\text{mm}$ (0.01inch) unless otherwise noted.
2. Specifications are subject to change without notice.
3. The gap between the reflector and PCB shall not exceed 0.25mm.

Internal Circuit Diagram

LD15011ARG (Common Cathode)

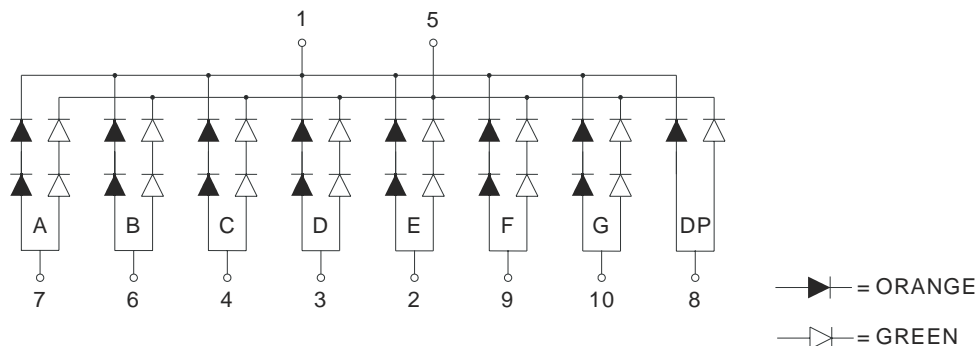

LD15011BRG (Common Anode)

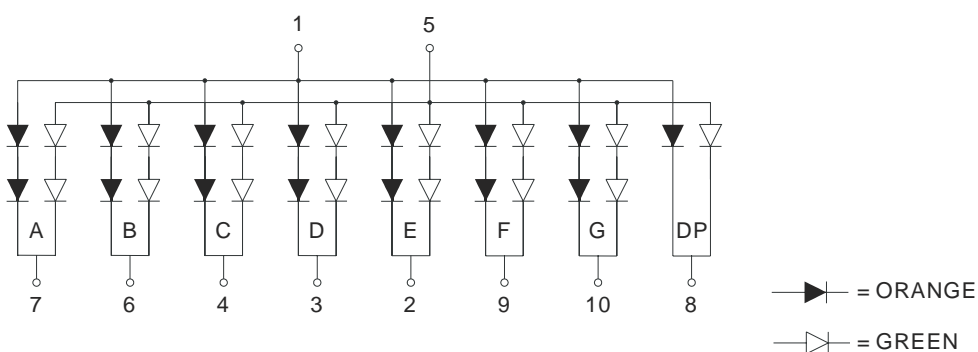

Selection Guide

Single Digit 7 Segment LED Display, Digit Height: 30.60mm(1.20inch), External Dimensions: 30.60x44.00x8.00mm (L x W x H)							
Description	Part No.		Chip			Iv(mcd)@20mA	
	Cathode Row	Anode Row	Material	Color	W LD (nm)	One Seg(DP)	
						Min.	Typ.
Standard Brightness	LD15011ARG	LD15011BRG	GaAlAs	Super Red	640	12(8)	15(10)
			GaP	Green	568	10.5(7)	13.5(9)
Ultra-High Brightness	LD15011AURUG	LD15011BURUG	AlGaInP	Ultra Red	640	45(30)	67.5(45)
			AlGaInP	Ultra Green	573	45(30)	67.5(45)

Electrical Characteristics & Absolute Maximum Ratings

LD12011BURPGUB		Electrical optical Characteristics ^[1]		Absolute Maximum Ratings ^[1]		
Color	Forward Voltage(V) @ IF=20mA		Reverse Current VR=5V (uA)	Power Dissipation (mW)	DC Forward Current (mA)	Peak Forward Current ^[2] (mA)
	One Seg (DP)	Typ.				
Super Red	3.6(1.8)	4.4(2.2)	50(30)	120(60)	25	100
Green	4.4(2.2)	5.0(2.5)	50(30)	160(80)	30	100
Ultra Red	3.8(1.9)	5.2(2.6)	50(30)	120(60)	30	100
Ultra Green	4.2(2.1)	5.2(2.6)	50(30)	150(75)	30	100

Operating/ Storage Temp.: -40 to +80 deg.;

Lead Solder Temp.: 260 deg. for 3-5 Sec. 2mm below package base

Notes:

1. At Ta = 25 °C.
2. Peak forward current at 1/10 Duty Cycle, 0.1ms Pulse.