

BGA7130

400 MHz to 2700 MHz 1 W high linearity silicon amplifier

Rev. 1 — 9 October 2012

Product data sheet

1. General description

The MMIC is a single-stage amplifier, offered in a leadless surface-mount package. It delivers 30 dBm output power at 1 dB gain compression and a superior performance up to 2700 MHz. Its power saving features include simple quiescent current adjustment and logic-level shutdown control to reduce the supply current to 4 μ A.

2. Features and benefits

- 400 MHz to 2700 MHz frequency operating range
- Integrated active biasing
- External matching allows broad application optimization of the electrical performance
- 5 V single supply operation
- Power-down
- Excellent robustness:
 - ◆ All pins ESD protected (HBM 6 kV; CDM 2 kV)
 - ◆ Withstands mismatch of VSWR 50 : 1 through all phases
 - ◆ Withstands electrical over-stress peaks of 7 V on the supply voltage

3. Applications

In this data sheet two base station applications are described, namely LTE at 750 MHz and UMTS at 2140 MHz. The BGA7130 is also suited for a range of other applications:

- Wireless infrastructure (base station, repeater, backhaul systems)
- Broadband CPE / MoCA
- Industrial applications
- WLAN / ISM / RFID
- Satellite Master Antenna TV (SMATV)

4. Quick reference data

Table 1. Quick reference data

$4.75\text{ V} \leq V_{\text{SUP}} \leq 5.25\text{ V}$; $-40\text{ }^{\circ}\text{C} \leq T_{\text{case}} \leq +85\text{ }^{\circ}\text{C}$; $P_i < -20\text{ dBm}$; $R_3 = 523\ \Omega$ (tolerance 1 %); input and output impedances matched to $50\ \Omega$ (see [Section 14](#)); pin ENABLE = HIGH; unless otherwise specified.

Symbol	Parameter	Conditions	Min	Typ	Max	Unit
V_{SUP}	supply voltage		1 4.75	-	5.25	V
$I_{\text{CC(tot)}}$	total supply current		2 390	450	510	mA
		$500\ \Omega \leq R_3 \leq 4.7\text{ k}\Omega$	2 50	-	550	mA
		$500\ \Omega \leq R_3 \leq 4.7\text{ k}\Omega$; pin ENABLE = LOW	2 -	4	6	μ A



Table 1. Quick reference data ...continued

4.75 V ≤ V_{SUP} ≤ 5.25 V; -40 °C ≤ T_{case} ≤ +85 °C; P_i < -20 dBm; R₃ = 523 Ω (tolerance 1 %); input and output impedances matched to 50 Ω (see [Section 14](#)); pin ENABLE = HIGH; unless otherwise specified.

Symbol	Parameter	Conditions	Min	Typ	Max	Unit
T _{case}	case temperature		[3] -40	+25	+85	°C
f	frequency		400	-	2700	MHz
Measured at LTE-750 MHz (see Section 14)						
f	frequency		[4] 728	748	768	MHz
G _p	power gain	728 MHz ≤ f ≤ 768 MHz	17	20	23	dB
P _{L(1dB)}	output power at 1 dB gain compression	728 MHz ≤ f ≤ 768 MHz	27	30.5	-	dBm
IP _{3O}	output third-order intercept point	728 MHz ≤ f ≤ 768 MHz; P _L = 19 dBm per tone; tone spacing = 1 MHz	39	42.5	-	dBm
Measured at UMTS-2140 MHz (see Section 14)						
f	frequency		[5] 2110	2140	2170	MHz
G _p	power gain	2110 MHz ≤ f ≤ 2170 MHz	9	12	15	dB
P _{L(1dB)}	output power at 1 dB gain compression	2110 MHz ≤ f ≤ 2170 MHz	27	30	-	dBm
IP _{3O}	output third-order intercept point	2110 MHz ≤ f ≤ 2170 MHz; P _L = 19 dBm per tone; tone spacing = 1 MHz	40.5	44	-	dBm

[1] Supply voltage on pins RF_OUT and V_{CC}.

[2] Current through pins RF_OUT and V_{CC}.

[3] T_{case} is the temperature at the soldering point of the exposed die pad.

[4] Covering downlink frequency range of eUTRAN bands 11, 13, 14 and 17.

[5] Covering downlink frequency range of eUTRAN bands 1, 4 and 10.

5. Design support

Table 2. Available design support

Download from the BGA7130 product page on <http://www.nxp.com>.

Support item	Available	Remarks
Device models for Agilent EEsof EDA ADS	planned	[1] Based on Mextram device model.
Device models for AWR Microwave Office	no	[1] Based on Mextram device model.
Device models for ANSYS Ansoft designer	no	[1] Based on Mextram device model.
SPICE model	planned	[1] Based on Gummel-Poon device model.
S-parameters	yes	
Noise parameters	yes	
Customer evaluation kit	yes	See Section 6 and Section 14 .
Gerber files	yes	Gerber files of boards provided with the customer evaluation kit.
Solder pattern	yes	

[1] See <http://www.nxp.com/models.html>.

6. Ordering information

Table 3. Ordering information

Type number	Package		Version
	Name	Description	
BGA7130	HVSON8	plastic thermal enhanced very thin small outline package; no leads; 8 terminals; body 3 × 3 × 0.85 mm	SOT908-3
OM7941/BGA7130LTE	-	Customer evaluation kit for BGA7130 in a 750 MHz LTE application [1]	-
OM7942/BGA7130WCDMA	-	Customer evaluation kit for BGA7130 in a 2140 MHz UMTS application [1]	-

- [1] The customer evaluation kit contains the following:
- a) Fully populated and matched RF evaluation board
 - b) BGA7130 samples

7. Functional diagram

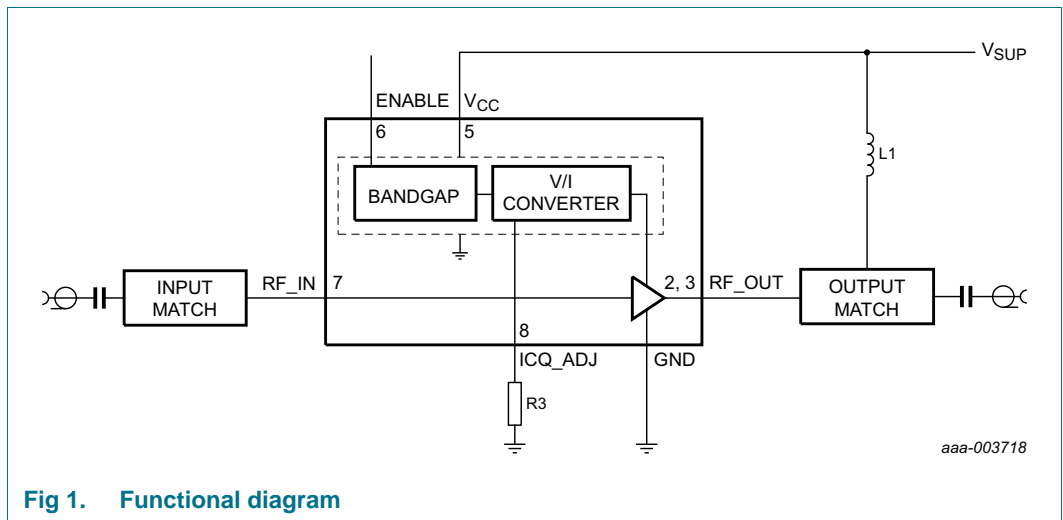
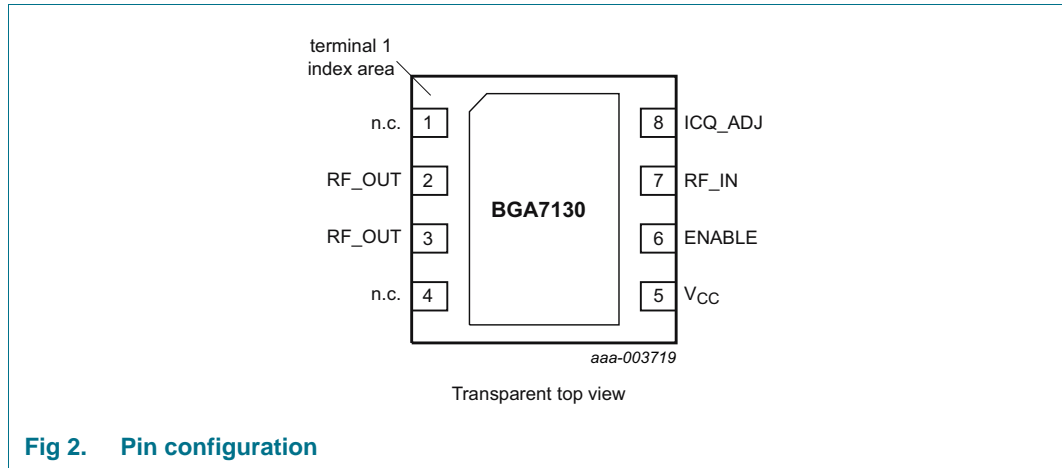

Fig 1. Functional diagram

8. Pinning information

8.1 Pinning



8.2 Pin description

Table 4. Pin description

Symbol	Pin	Description
n.c.	1, 4	not connected [1]
RF_OUT	2, 3	RF output and supply to the amplifier [2]
V _{CC}	5	bias supply voltage [3]
ENABLE	6	enable
RF_IN	7	RF input [2]
ICQ_ADJ	8	quiescent collector current adjustment by an external resistor
GND	exposed die pad	ground [4]

[1] This pin can be connected to ground.

[2] This pin requires an external DC-blocking capacitor.

[3] RF decoupled.

[4] The exposed die pad of the SOT908-3 also functions as heatsink for the power amplifier.

9. Functional description

9.1 Supply current adjustment

The supply current can be adjusted by changing the value of biasing resistor R3 which connects pin ICQ_ADJ (pin 8) to ground (see [Figure 1](#)).

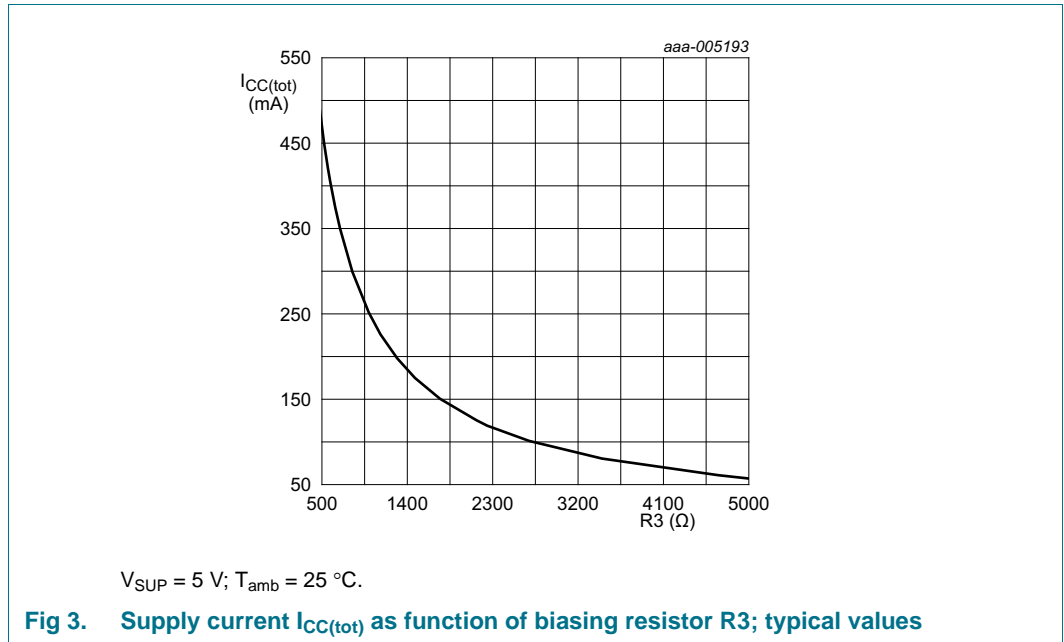

9.2 Enable control

The BGA7130 can be powered down using enable pin 6 (ENABLE). In case this control function is not needed the enable pin can be connected to the bias supply voltage pin 5 (V_{CC}). The current through the enable pin 6 should never exceed 20 mA as this might damage the ESD protection circuitry. This can be avoided either by preventing the voltage on this pin to exceed the supply voltage (V_{SUP}) or by adding a series resistor.

Table 5. Enable truth table

Logic level on pin ENABLE (pin 6)	Status BGA7130
LOW	powered down
HIGH	powered on

10. Limiting values

Table 6. Limiting values

In accordance with the Absolute Maximum Rating System (IEC 60134).

Symbol	Parameter	Conditions	Min	Max	Unit
V_{SUP}	supply voltage		[1] -0.5	+7	V
$V_{I(dig)}$	digital input voltage		[2][4] 0	V_{SUP}	V
$I_{I(dig)}$	digital input current		[3][4] -20	+20	mA
$I_{CC(tot)}$	total supply current		-	1000	mA

Table 6. Limiting values ...continued
In accordance with the Absolute Maximum Rating System (IEC 60134).

Symbol	Parameter	Conditions	Min	Max	Unit
P _{I(RF)}	RF input power	f = 750 MHz; switched	-	18	dBm
		f = 2140 MHz; switched	-	25	dBm
T _{stg}	storage temperature		-65	+150	°C
T _j	junction temperature		-	150	°C
V _{ESD}	electrostatic discharge voltage	Human Body Model (HBM); According JEDEC standard 22-A114E	-	6	kV
		Charged Device Model (CDM); According JEDEC standard 22-C101B	-	2	kV

- [1] Absolute maximum DC voltage on pins RF_OUT, ICQ_ADJ and V_{CC}.
- [2] Absolute maximum DC voltage on pin ENABLE.
- [3] Absolute maximum DC current through pin ENABLE.
- [4] If V_{I(dig)} exceeds V_{SUP} the internal ESD protection circuit can be damaged. The pin ENABLE can be connected to V_{CC} in case the enable control function is not used (see [Section 9.2](#)).

11. Thermal characteristics

Table 7. Thermal characteristics

Symbol	Parameter	Conditions	Typ	Unit
R _{th(j-case)}	thermal resistance from junction to case	T _{case} < 85 °C	6	K/W

12. Static characteristics

Table 8. Static characteristics

4.75 V ≤ V_{SUP} ≤ 5.25 V; -40 °C ≤ T_{case} ≤ +85 °C; P_i < -20 dBm; R₃ = 523 Ω (tolerance 1 %); input and output impedances matched to 50 Ω (see [Section 14](#)); pin ENABLE = HIGH; unless otherwise specified.

Symbol	Parameter	Conditions	Min	Typ	Max	Unit
V _{SUP}	supply voltage		[1] 4.75	-	5.25	V
I _{CC(tot)}	total supply current		[2] 390	450	510	mA
		0 Ω ≤ R ₃ ≤ 5 kΩ	[2] 30	-	550	mA
		0 Ω ≤ R ₃ ≤ 5 kΩ; pin ENABLE = LOW	[2] -	4	6	μA
T _{case}	case temperature		[3] -40	+25	+85	°C
I _{CC}	supply current	on pin RF_OUT	-	420	-	mA
		on pin V _{CC}	-	30	-	mA
		on pin ENABLE	-	-	3	μA
V _{IL}	LOW-level input voltage		[4] 0	-	0.7	V
V _{IH}	HIGH-level input voltage		[4] 2.5	-	V _{SUP}	V

- [1] Supply voltage on pins RF_OUT and V_{CC}.
- [2] Current through pins RF_OUT and V_{CC}.
- [3] T_{case} is the temperature at the soldering point of the exposed die pad.
- [4] On digital input pin ENABLE.

13. Dynamic characteristics

Table 9. Dynamic characteristics

$4.75\text{ V} \leq V_{SUP} \leq 5.25\text{ V}$; $-40\text{ }^{\circ}\text{C} \leq T_{case} \leq 85\text{ }^{\circ}\text{C}$; $P_i < -20\text{ dBm}$; $R_3 = 523\ \Omega$ (tolerance 1 %); input and output impedances matched to $50\ \Omega$ (see [Section 14](#)); pin ENABLE = HIGH; unless otherwise specified.

Symbol	Parameter	Conditions	Min	Typ	Max	Unit
f	frequency		400	-	2700	MHz
Measured at LTE-750 MHz (see Section 14)						
f	frequency		[1] 728	748	768	MHz
G _p	power gain	728 MHz ≤ f ≤ 768 MHz	17	20	23	dB
		728 MHz ≤ f ≤ 768 MHz; pin ENABLE = LOW	-	-18	-	dB
P _{L(1dB)}	output power at 1 dB gain compression	728 MHz ≤ f ≤ 768 MHz	27	30.5	-	dBm
IP _{3O}	output third-order intercept point	728 MHz ≤ f ≤ 768 MHz; P _L = 15 dBm per tone; tone spacing = 1 MHz	39	42.5	-	dBm
EVM	error vector magnitude	E-UTRA Test Model (E-TM) 3.1 LTE; P _{L(AV)} = 20 dBm	-	2	-	%
NF	noise figure	728 MHz ≤ f ≤ 768 MHz	-	5	-	dB
RL _{in}	input return loss	728 MHz ≤ f ≤ 768 MHz	-	6	-	dB
		728 MHz ≤ f ≤ 768 MHz; pin ENABLE = LOW	-	1	-	dB
RL _{out}	output return loss	728 MHz ≤ f ≤ 768 MHz	-	10	-	dB
		728 MHz ≤ f ≤ 768 MHz; pin ENABLE = LOW	-	0.5	-	dB
ISL	isolation	728 MHz ≤ f ≤ 768 MHz	-	29	-	dB
		728 MHz ≤ f ≤ 768 MHz; pin ENABLE = LOW	-	18	-	dB
t _{d(pu)}	power-up delay time	after pin ENABLE is switched to logic HIGH; to within 0.1 dB of final gain state.	-	3	-	μs
t _{d(pd)}	power-down delay time	after pin ENABLE is switched to logic LOW; to within 0.1 dB of final gain state.	-	0.5	-	μs
Measured at UMTS-2140 MHz (see Section 14)						
f	frequency		[2] 2110	2140	2170	MHz
G _p	power gain	2110 MHz ≤ f ≤ 2170 MHz	9	12	15	dB
		2110 MHz ≤ f ≤ 2170 MHz; pin ENABLE = LOW	-	-15	-	dB
P _{L(1dB)}	output power at 1 dB gain compression	2110 MHz ≤ f ≤ 2170 MHz	27	30	-	dBm
IP _{3O}	output third-order intercept point	2110 MHz ≤ f ≤ 2170 MHz; P _L = 15 dBm per tone; tone spacing = 1 MHz	41	44	-	dBm
ACPR	adjacent channel power ratio	2110 MHz ≤ f ≤ 2170 MHz	[3] -	-60	-	dBc
NF	noise figure	2110 MHz ≤ f ≤ 2170 MHz	-	5	-	dB
RL _{in}	input return loss	2110 MHz ≤ f ≤ 2170 MHz	-	6	-	dB
		2110 MHz ≤ f ≤ 2170 MHz; pin ENABLE = LOW	-	3	-	dB
RL _{out}	output return loss	2110 MHz ≤ f ≤ 2170 MHz	-	10	-	dB
		2110 MHz ≤ f ≤ 2170 MHz; pin ENABLE = LOW	-	1	-	dB

Table 9. Dynamic characteristics ...continued

4.75 V ≤ V_{SUP} ≤ 5.25 V; -40 °C ≤ T_{case} ≤ 85 °C; P_i < -20 dBm; R₃ = 523 Ω (tolerance 1 %); input and output impedances matched to 50 Ω (see Section 14); pin ENABLE = HIGH; unless otherwise specified.

Symbol	Parameter	Conditions	Min	Typ	Max	Unit
ISL	isolation	2110 MHz ≤ f ≤ 2170 MHz	-	24	-	dB
		2110 MHz ≤ f ≤ 2170 MHz; pin ENABLE = LOW	-	15	-	dB
t _{d(pu)}	power-up delay time	after pin ENABLE is switched to logic HIGH; to within 0.1 dB of final gain state.	-	3	-	μs
t _{d(pd)}	power-down delay time	after pin ENABLE is switched to logic LOW; to within 0.1 dB of final gain state.	-	0.5	-	μs

- [1] Covering downlink frequency range of eUTRAN bands 11, 13, 14 and 17.
- [2] Covering downlink frequency range of eUTRAN bands 1, 4 and 10.
- [3] Two carrier W-CDMA; each carrier according to 3GPP test model 1; 64 DPCH; PAR for composite signal = 7 dB; 5 MHz carrier spacing.

14. Application information

The BGA7130 can be used for a wide variety of applications. This section describes two example base station applications: LTE at 750 MHz and UMTS at 2140 MHz. It serves as a pre-driver for the high-power amplifier in the Base Transceiver Station (BTS), see Figure 4.

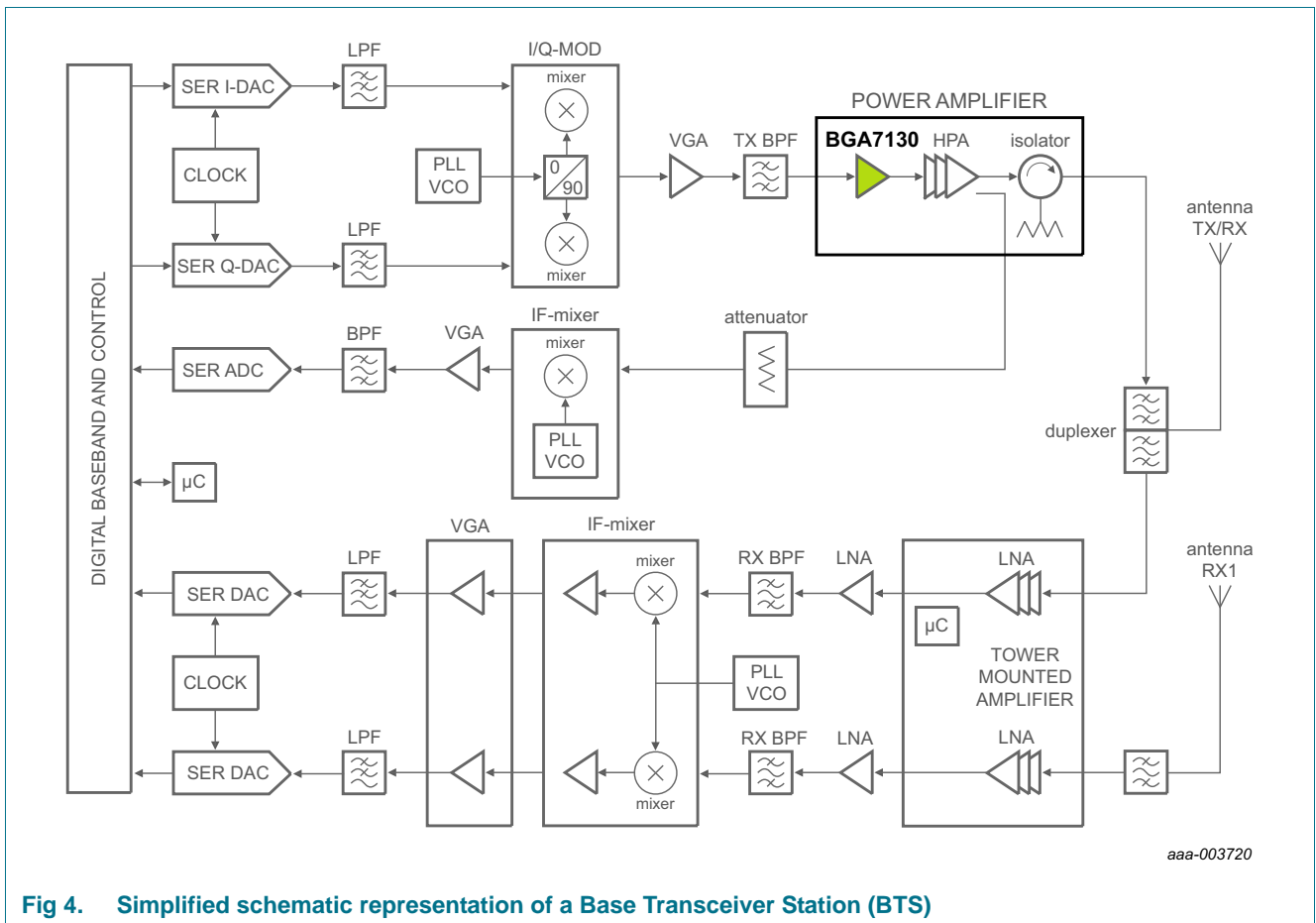

Fig 4. Simplified schematic representation of a Base Transceiver Station (BTS)

The LTE 750 MHz circuit described here is matched for the downlink frequency range of band 12, 13, 14 and 17 as defined in the evolved UMTS Terrestrial Radio Access Network (eUTRAN) air interface of Long Term Evolution (LTE) mobile networks. These bands are used in the United States and are expected to be used in Canada in the future. Band 12, 13 and 14 are commonly referred to as SMH bands.

Table 10. Covered LTE downlink bands

eUTRAN band	Uplink	Downlink	Region
XII (12) - SMH	698 MHz to 716 MHz	728 MHz to 746 MHz	United States, Canada
XIII (13) - SMH	776 MHz to 787 MHz	746 MHz to 757 MHz	United States, Canada
XIV (14) - SMH	788 MHz to 798 MHz	758 MHz to 768 MHz	United States, Canada
XVII (17)	704 MHz to 716 MHz	734 MHz to 746 MHz	United States, Canada

The UMTS 2140 MHz circuit described here is matched for the downlink frequency range of band 1, 4 and 10 as defined in the evolved UMTS Terrestrial Radio Access Network (eUTRAN) air interface of the Universal Mobile Telecommunications System (UMTS) mobile networks.

Table 11. Covered UMTS bands

eUTRAN band	Uplink	Downlink	Region
I (1) - UMTS	1920 MHz to 1980 MHz	2110 MHz to 2170 MHz	Japan, Europe, Asia
IV (4) - AWS	1710 MHz to 1755 MHz	2110 MHz to 2155 MHz	United States, Canada, Latin America
X (10) - UMTS	1710 MHz to 1770 MHz	2110 MHz to 2170 MHz	Uruguay, Ecuador, Peru

14.1 Application board

Customer evaluation boards are available from NXP (see [Section 6 “Ordering information”](#)). The BGA7130 shall be decoupled and matched as depicted in [Figure 5](#). The ground leads and exposed paddle should be connected directly to the ground plane. Enough via holes should be provided to connect top and bottom ground planes in the final application board. Sufficient cooling should be provided preventing the temperature of the exposed die pad from exceeding 85 °C.

The LTE-750 and UMTS-2140 application boards differ in input and output matching topology have the same input and output matching topology.

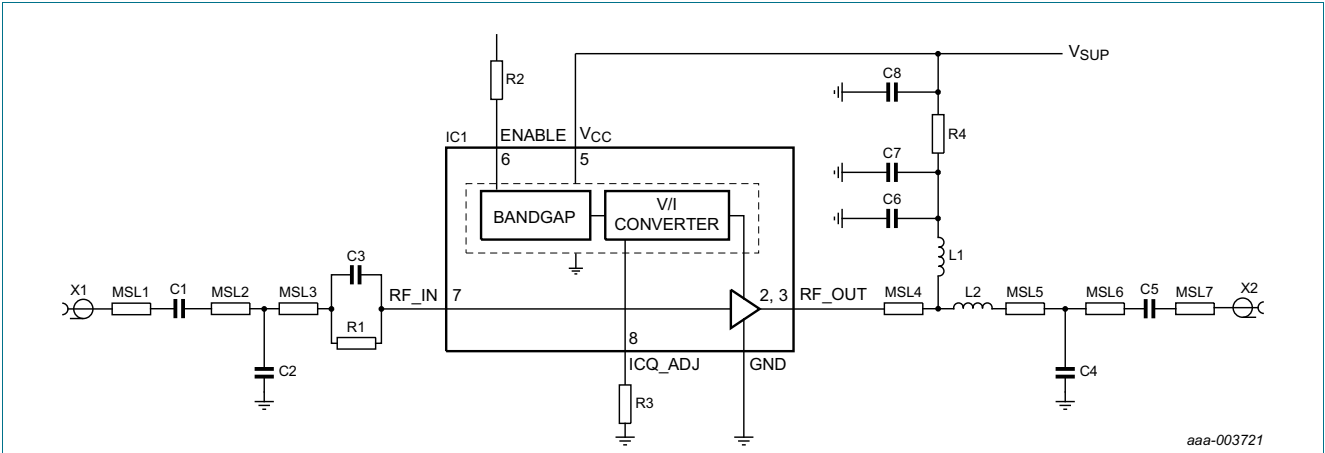

See [Table 12](#) for list of components.

Fig 5. Application diagram of customer evaluation board for LTE-750 application

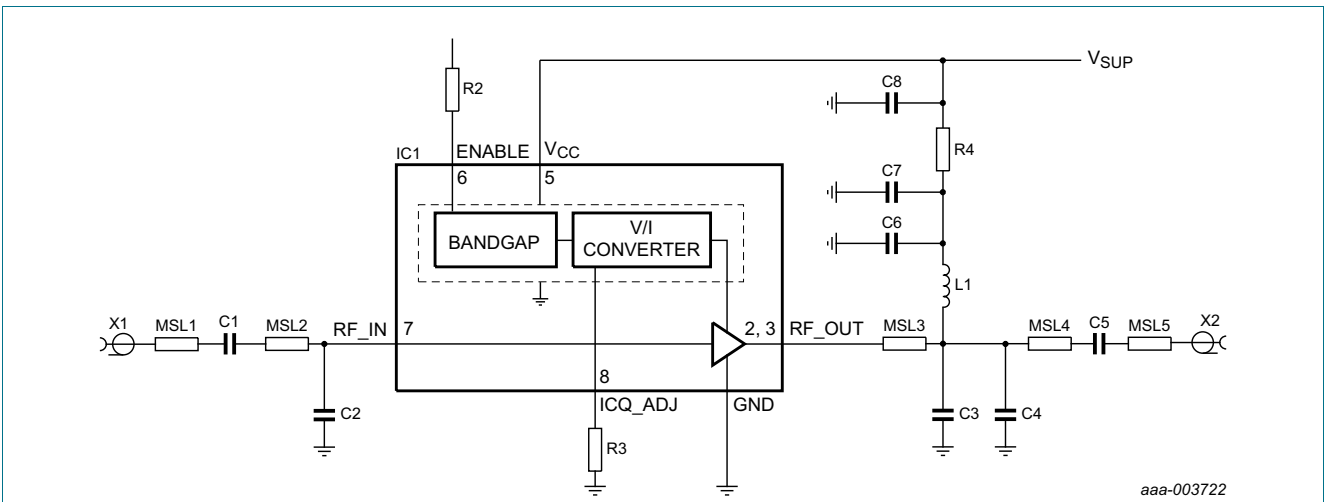

See [Table 12](#) for list of components.

Fig 6. Application diagram of customer evaluation board for UMTS-2140 application

The Printed-Circuit Board (PCB) is a four metal layer substrate board as described in [Figure 7](#). The width and the gap between the strip-line and ground plane are configured such that a 50 ohm transmission line is obtained.

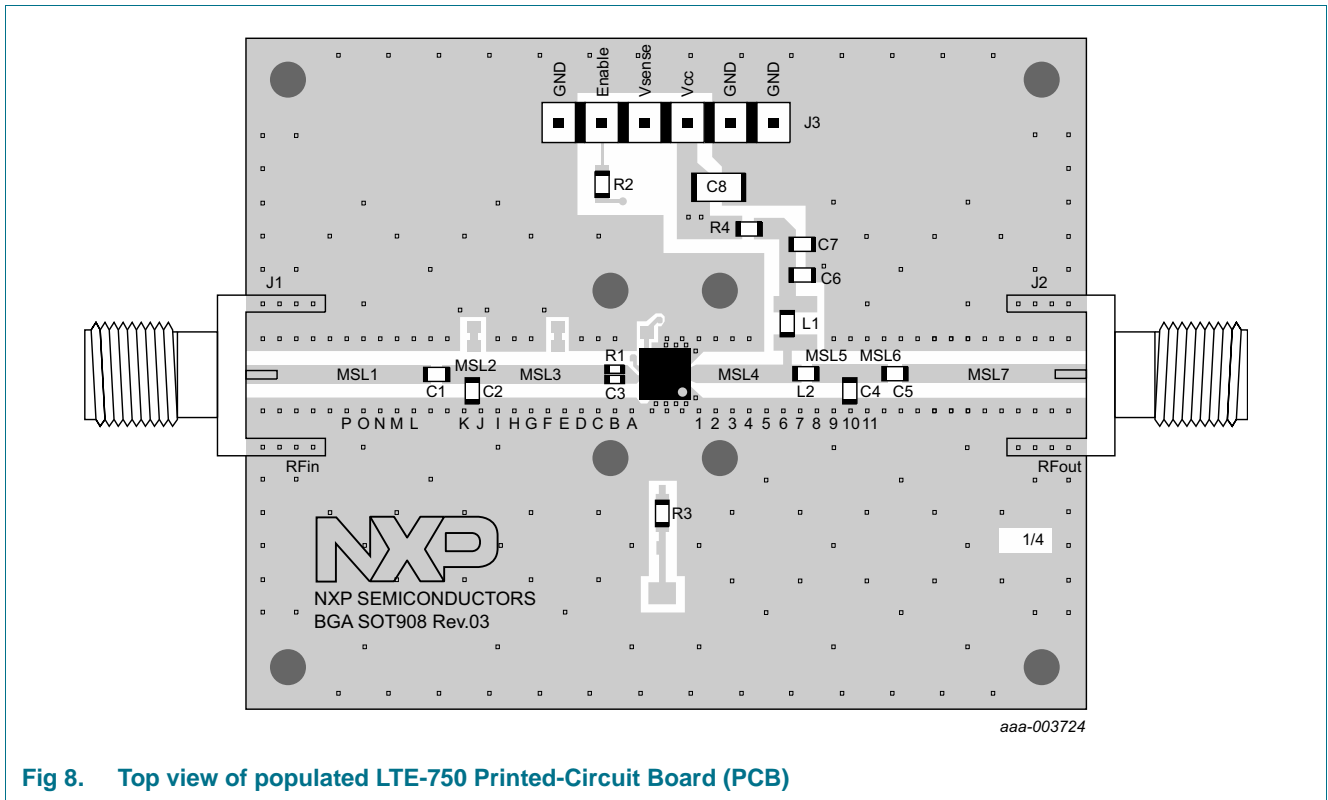
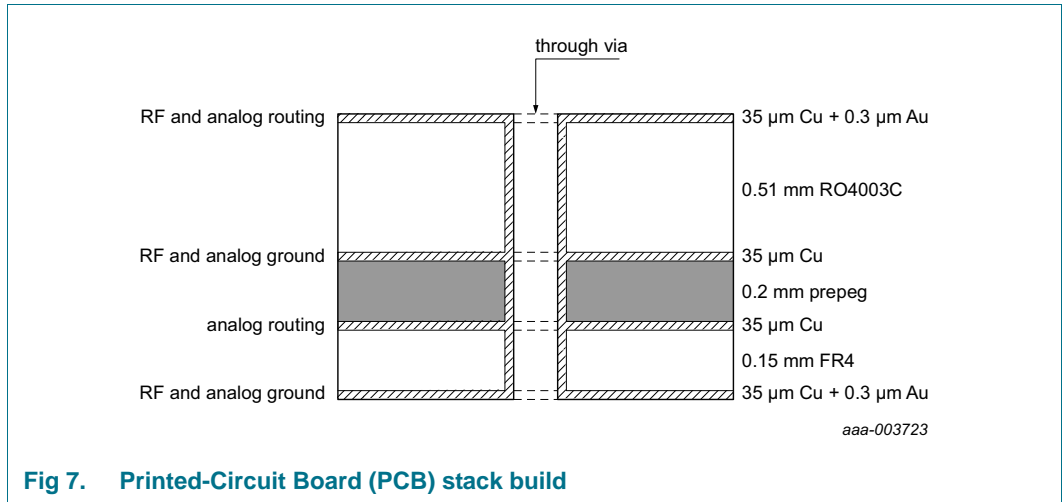

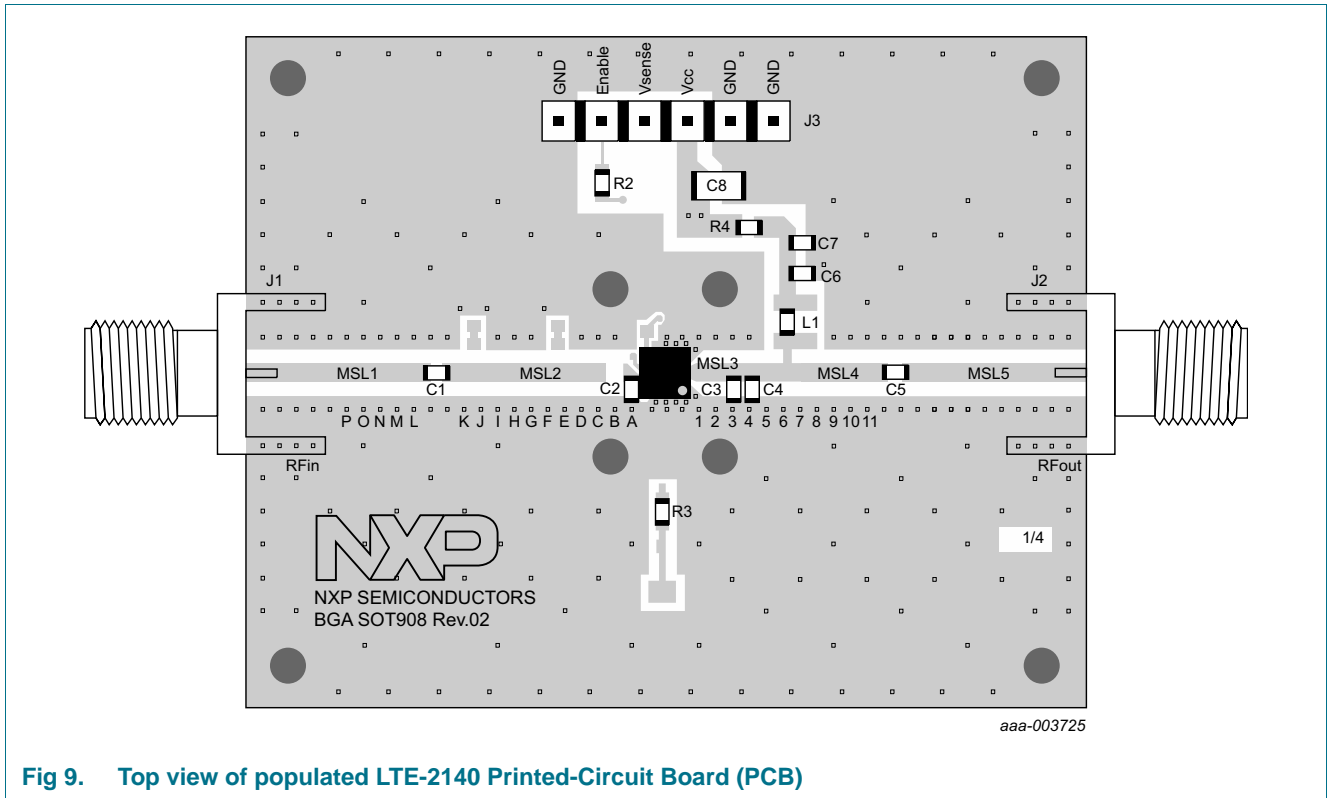

Fig 9. Top view of populated LTE-2140 Printed-Circuit Board (PCB)

Table 12. List of components

See Figure 5 for schematics.

Component	Description	Value		Remarks
		LTE-750	UMTS-2140	
C1, C5	capacitor	47 pF	15 pF	
C2	capacitor	12 pF	3.3 pF	
C3	capacitor	47 pF	0.82 pF	
C4	capacitor	10 pF	2.2 pF	
C6	capacitor	1 nF	10 nF	
C7	capacitor	100 nF	1 μF	
C8	capacitor	10 μF	10 μF	
IC1	BGA7130	-	-	NXP
MSL1	micro stripline	10.95 mm	10.95 mm	[1]
MSL2	micro stripline	1.5 mm	11.2 mm	[1]
MSL3	micro stripline	8.0 mm	3.3 mm	[1]
MSL4	micro stripline	6.3 mm	8.6 mm	[1]
MSL5	micro stripline	1.9 mm	10.95 mm	[1]
MSL6	micro stripline	2.0 mm	-	[1]
MSL7	micro stripline	10.95 mm	-	[1]
R1	resistor	47 Ω	-	
R2	resistor	240 Ω	240 Ω	
R3	resistor	523 Ω	523 Ω	

Table 12. List of components ...continued
See [Figure 5](#) for schematics.

Component	Description	Value		Remarks
		LTE-750	UMTS-2140	
R4	resistor	0 Ω	0 Ω	
L1	RF choke	68 nH	18 nH	
L2	inductor	1.5 nH	-	
X1, X2	SMA connector	-	-	

[1] length (L) is specified, width (W) = 1.14 mm and spacing (S) = 0.8 mm.

14.2 Characteristics LTE-750

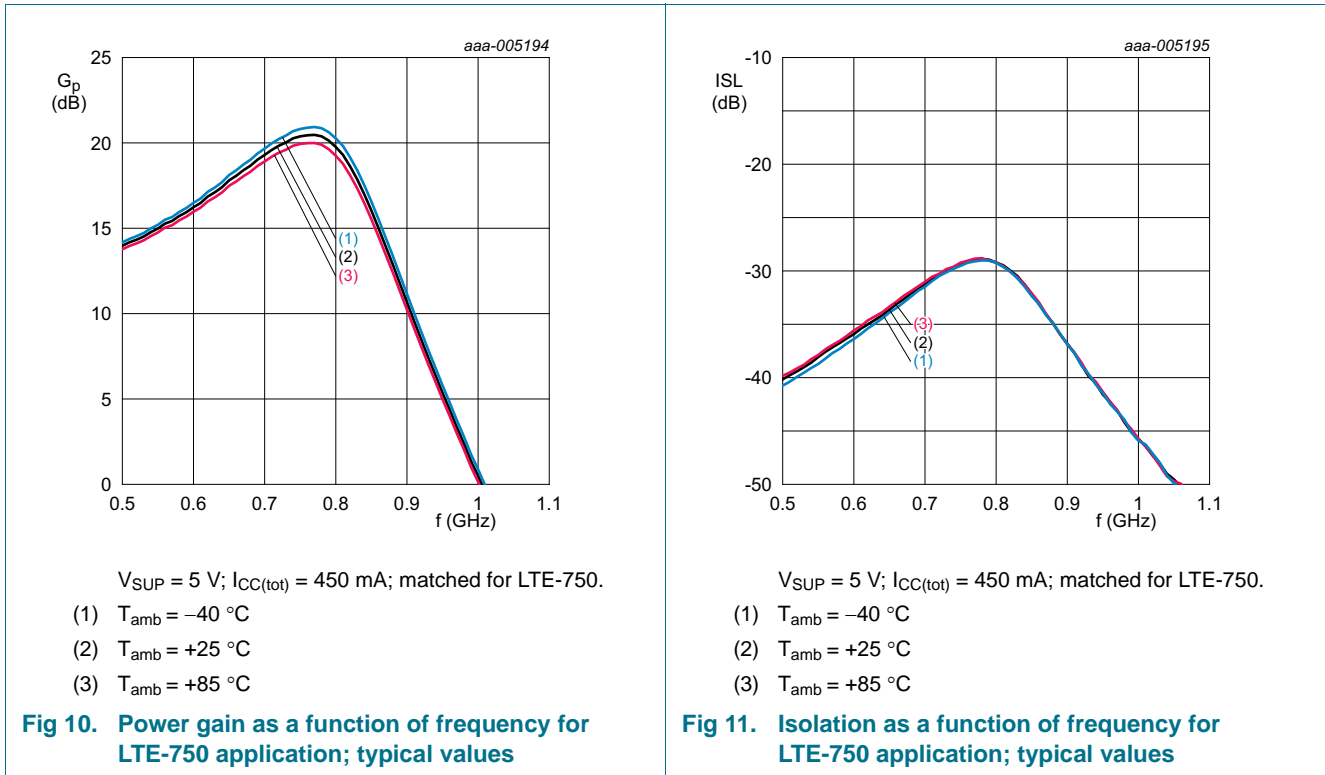

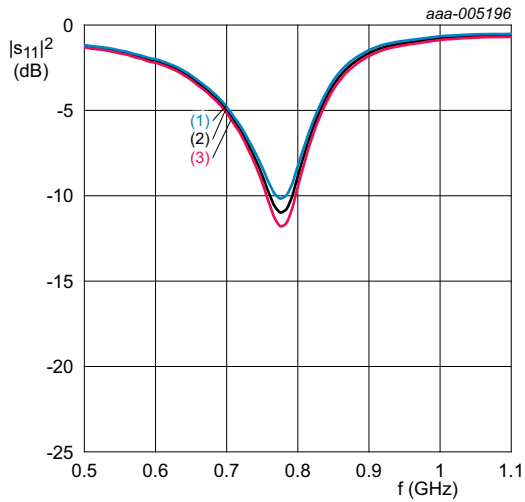

$V_{SUP} = 5\text{ V}$; $I_{CC(tot)} = 450\text{ mA}$; matched for LTE-750.
 (1) $T_{amb} = -40\text{ }^{\circ}\text{C}$
 (2) $T_{amb} = +25\text{ }^{\circ}\text{C}$
 (3) $T_{amb} = +85\text{ }^{\circ}\text{C}$

Fig 12. Input return loss as a function of frequency for LTE-750 application; typical values

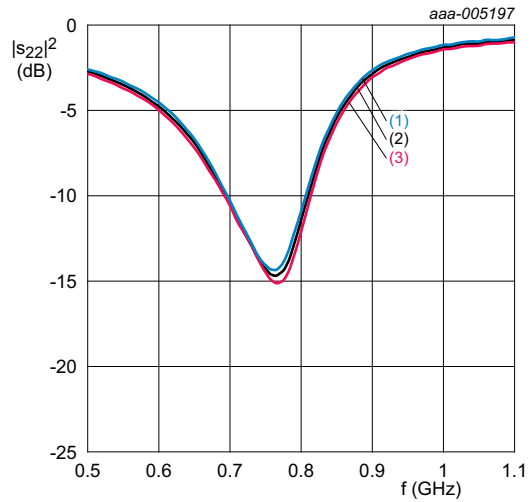

$V_{SUP} = 5\text{ V}$; $I_{CC(tot)} = 450\text{ mA}$; matched for LTE-750.
 (1) $T_{amb} = -40\text{ }^{\circ}\text{C}$
 (2) $T_{amb} = +25\text{ }^{\circ}\text{C}$
 (3) $T_{amb} = +85\text{ }^{\circ}\text{C}$

Fig 13. Output return loss as a function of frequency for LTE-750 application; typical values

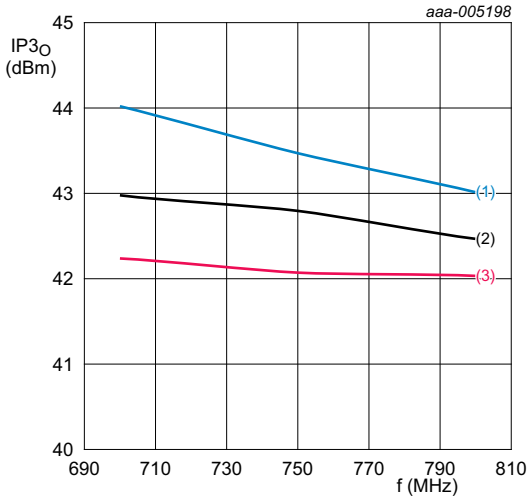

$V_{SUP} = 5\text{ V}$; $I_{CC(tot)} = 450\text{ mA}$; $P_L = 19\text{ dBm}$ per tone;
 $f = 748\text{ MHz}$; $\Delta f = 1\text{ MHz}$; matched for LTE-750.
 (1) $T_{amb} = -40\text{ }^{\circ}\text{C}$
 (2) $T_{amb} = +25\text{ }^{\circ}\text{C}$
 (3) $T_{amb} = +85\text{ }^{\circ}\text{C}$

Fig 14. Output third order intercept point as a function of frequency for LTE-750 application; different temperatures; typical values

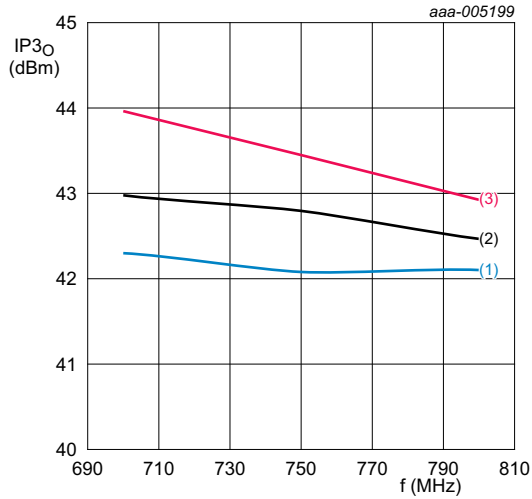

$T_{amb} = 25\text{ }^{\circ}\text{C}$; $I_{CC(tot)} = 450\text{ mA}$; $P_L = 19\text{ dBm}$ per tone;
 $f = 748\text{ MHz}$; $\Delta f = 1\text{ MHz}$; matched for LTE-750.
 (1) $V_{SUP} = 4.75\text{ V}$
 (2) $V_{SUP} = 5\text{ V}$
 (3) $V_{SUP} = 5.25\text{ V}$

Fig 15. Output third order intercept point as a function of frequency for LTE-750 application; different supply voltages; typical values

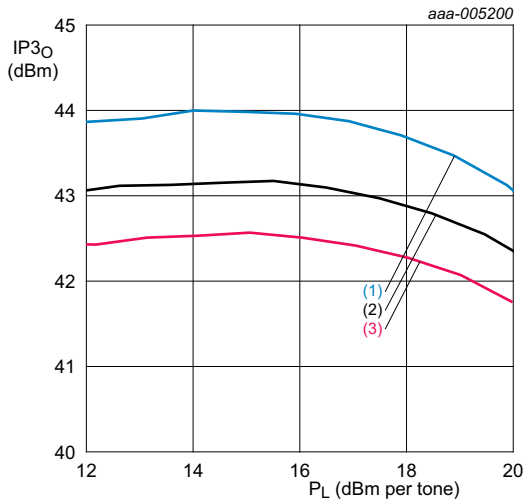

$V_{SUP} = 5\text{ V}$; $I_{CC(tot)} = 450\text{ mA}$; $f = 748\text{ MHz}$; $\Delta f = 1\text{ MHz}$; matched for LTE-750.

- (1) $T_{amb} = -40\text{ }^{\circ}\text{C}$
- (2) $T_{amb} = +25\text{ }^{\circ}\text{C}$
- (3) $T_{amb} = +85\text{ }^{\circ}\text{C}$

Fig 16. Output third order intercept point as a function of output power for LTE-750 application; different temperatures; typical values

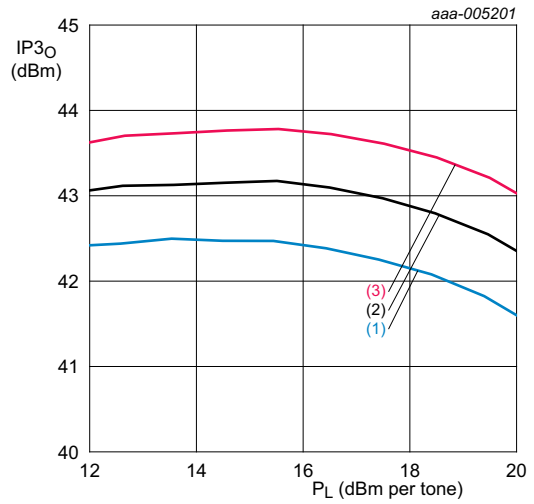

$T_{amb} = 25\text{ }^{\circ}\text{C}$; $I_{CC(tot)} = 450\text{ mA}$; $f = 748\text{ MHz}$; $\Delta f = 1\text{ MHz}$; matched for LTE-750.

- (1) $V_{SUP} = 4.75\text{ V}$
- (2) $V_{SUP} = 5\text{ V}$
- (3) $V_{SUP} = 5.25\text{ V}$

Fig 17. Output third order intercept point as a function of output power for LTE-750 application; different supply voltages; typical values

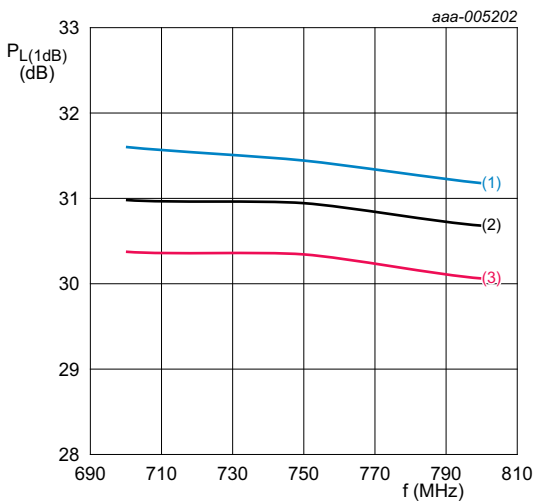

$V_{SUP} = 5\text{ V}$; $I_{CC(tot)} = 450\text{ mA}$; matched for LTE-750.

- (1) $T_{amb} = -40\text{ }^{\circ}\text{C}$
- (2) $T_{amb} = +25\text{ }^{\circ}\text{C}$
- (3) $T_{amb} = +85\text{ }^{\circ}\text{C}$

Fig 18. Output power at 1 dB gain compression as a function of frequency for LTE-750 application; different temperatures; typical values

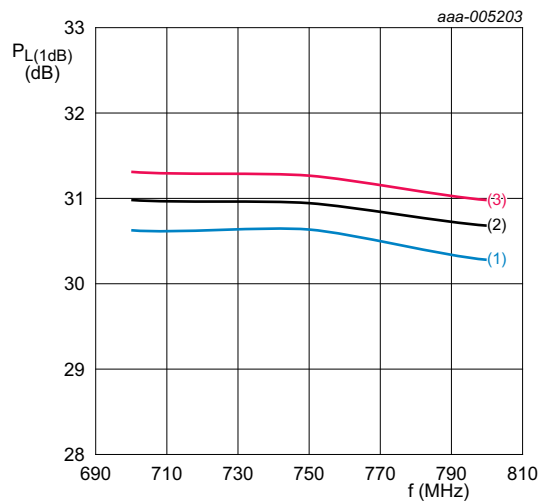

$T_{amb} = 25\text{ }^{\circ}\text{C}$; $I_{CC(tot)} = 450\text{ mA}$; matched for LTE-750.

- (1) $V_{SUP} = 4.75\text{ V}$
- (2) $V_{SUP} = 5\text{ V}$
- (3) $V_{SUP} = 5.25\text{ V}$

Fig 19. Output power at 1 dB gain compression as a function of frequency for LTE-750 application; different supply voltages; typical values

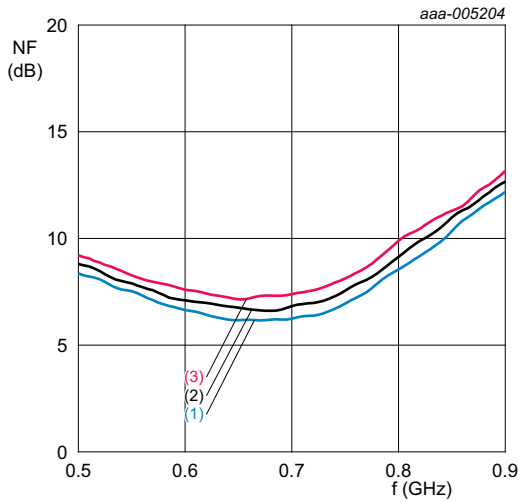

$V_{SUP} = 5\text{ V}$; $I_{CC(tot)} = 450\text{ mA}$; matched for LTE-750.
 (1) $T_{amb} = -40\text{ }^{\circ}\text{C}$
 (2) $T_{amb} = +25\text{ }^{\circ}\text{C}$
 (3) $T_{amb} = +85\text{ }^{\circ}\text{C}$

Fig 20. Noise figure as a function of frequency for LTE-750 application; different temperatures; typical values

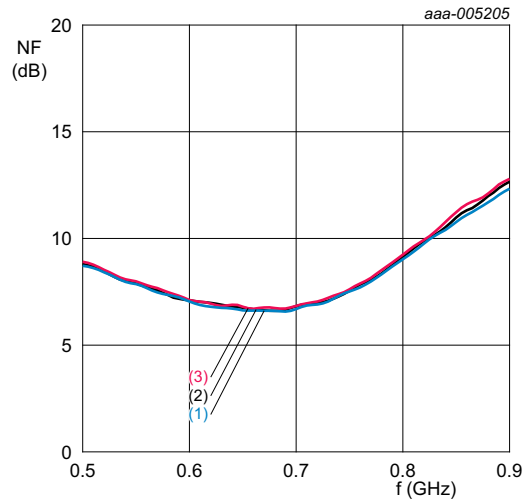

$T_{amb} = 25\text{ }^{\circ}\text{C}$; $I_{CC(tot)} = 450\text{ mA}$; matched for LTE-750.
 (1) $V_{SUP} = 4.75\text{ V}$
 (2) $V_{SUP} = 5\text{ V}$
 (3) $V_{SUP} = 5.25\text{ V}$

Fig 21. Noise figure as a function of frequency for LTE-750 application; different supply voltages; typical values

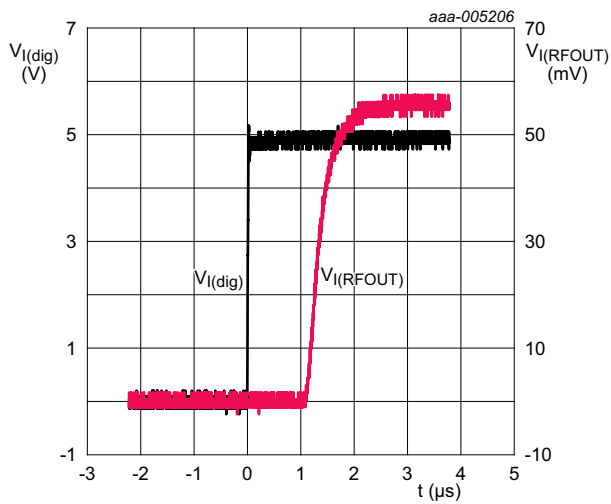

$V_{SUP} = 5\text{ V}$; $I_{CC(tot)} = 450\text{ mA}$; matched for LTE-750.

Fig 22. Power-on delay time; typical values

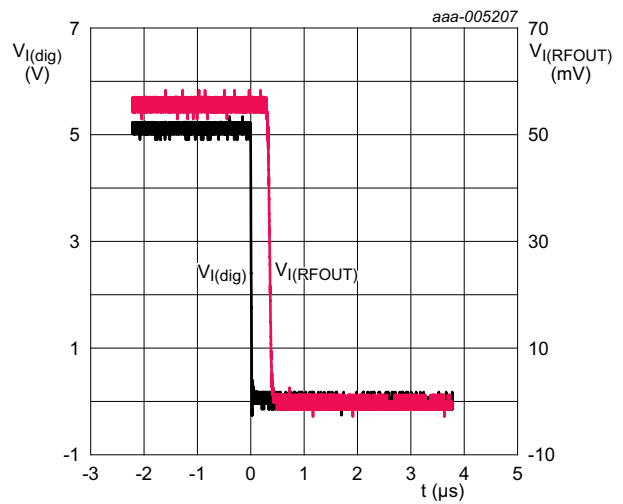

$V_{SUP} = 5\text{ V}$; $I_{CC(tot)} = 450\text{ mA}$; matched for LTE-750.

Fig 23. Power-down delay time; typical values

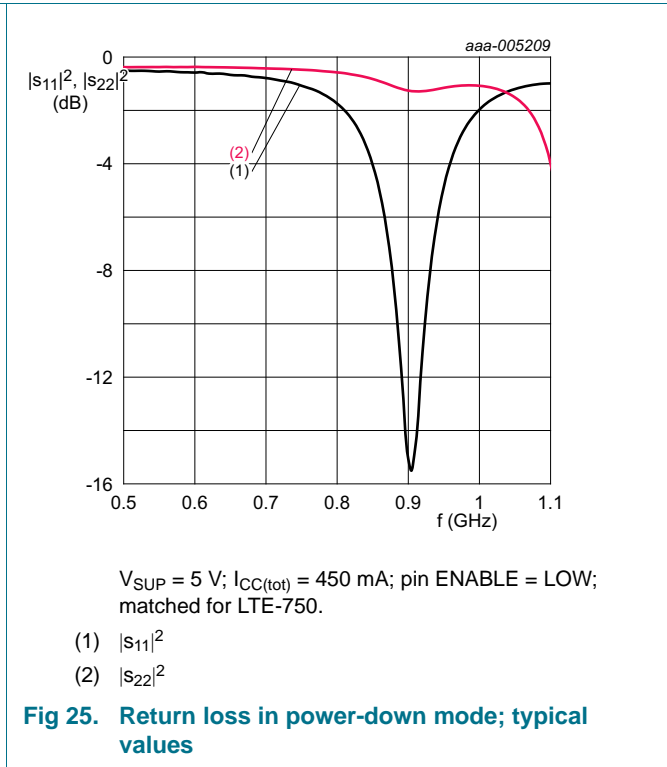
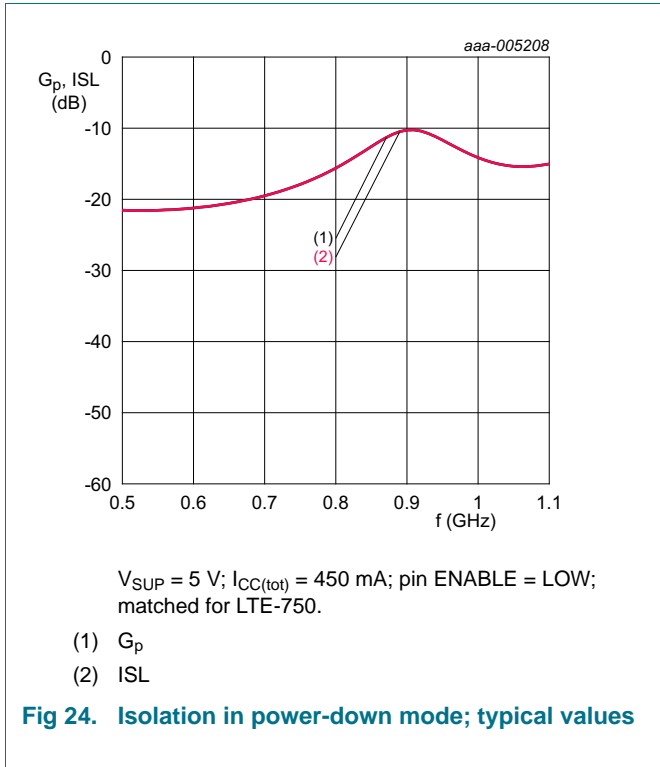

14.3 Characteristics UMTS-2140

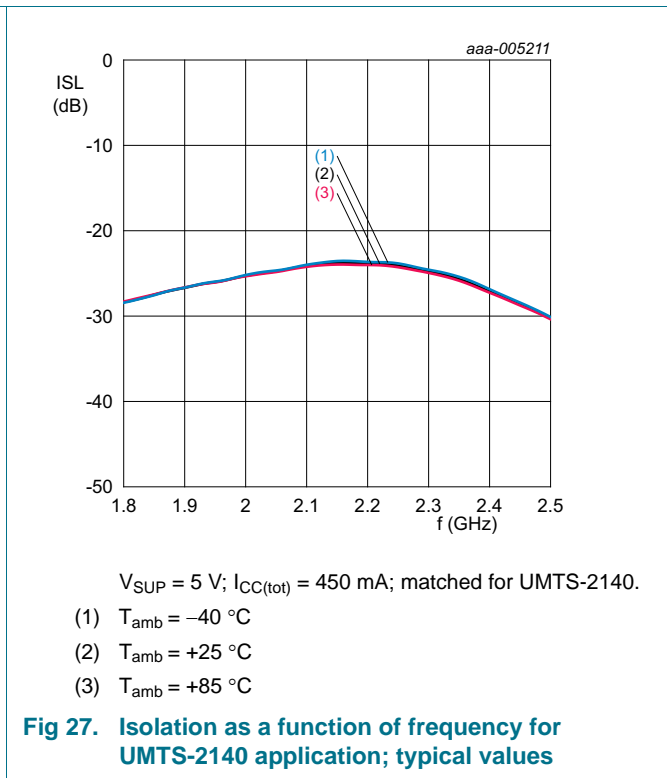
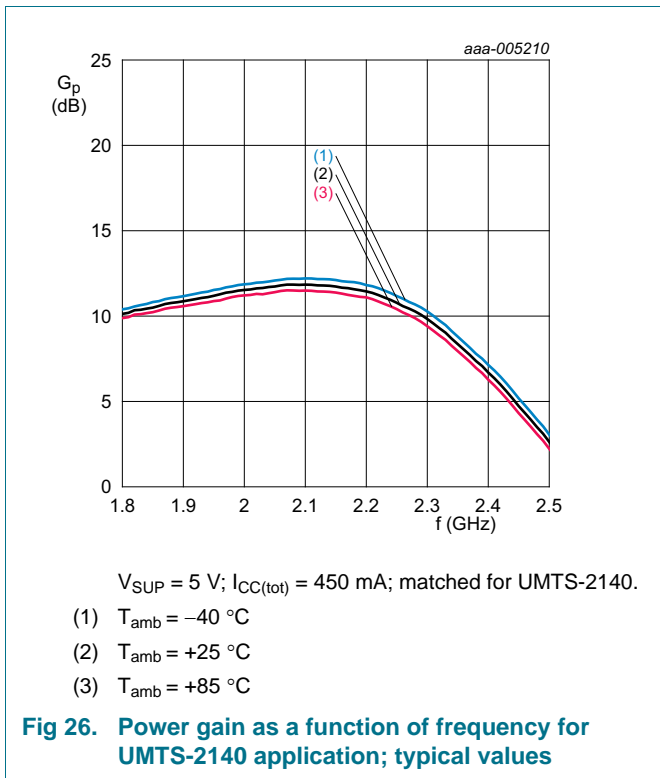

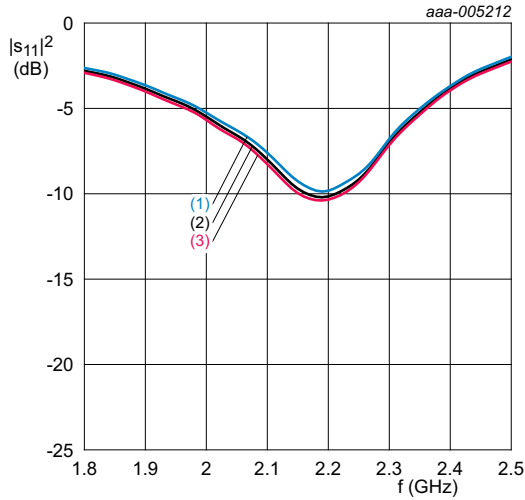

$V_{SUP} = 5\text{ V}$; $I_{CC(tot)} = 450\text{ mA}$; matched for UMTS-2140.
 (1) $T_{amb} = -40\text{ °C}$
 (2) $T_{amb} = +25\text{ °C}$
 (3) $T_{amb} = +85\text{ °C}$

Fig 28. Input return loss as a function of frequency for UMTS-2140 application; typical values

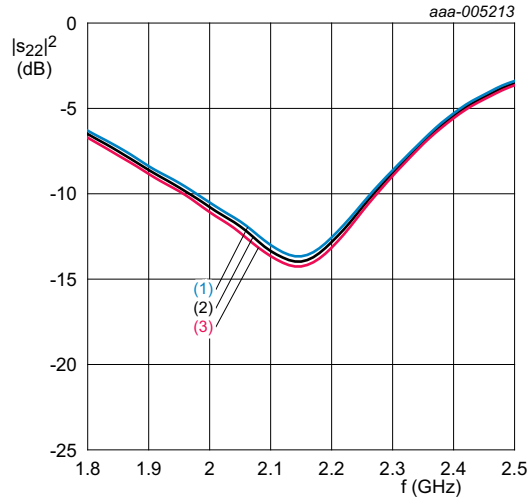

$V_{SUP} = 5\text{ V}$; $I_{CC(tot)} = 450\text{ mA}$; matched for UMTS-2140.
 (1) $T_{amb} = -40\text{ °C}$
 (2) $T_{amb} = +25\text{ °C}$
 (3) $T_{amb} = +85\text{ °C}$

Fig 29. Output return loss as a function of frequency for UMTS-2140 application; typical values

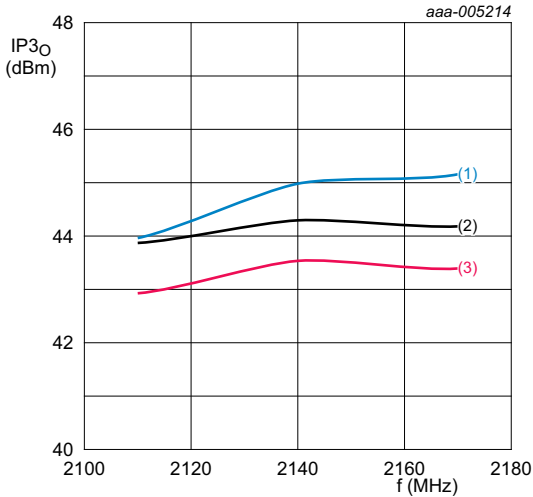

$V_{SUP} = 5\text{ V}$; $I_{CC(tot)} = 450\text{ mA}$; $P_L = 15\text{ dBm}$ per tone;
 $\Delta f = 1\text{ MHz}$; matched for UMTS-2140.
 (1) $T_{amb} = -40\text{ °C}$
 (2) $T_{amb} = +25\text{ °C}$
 (3) $T_{amb} = +85\text{ °C}$

Fig 30. Third order intermodulation distortion as a function of frequency for UMTS-2140 application; different temperatures; typical values

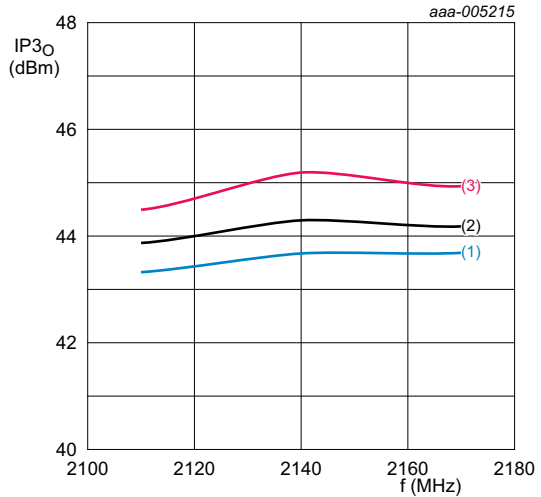

$T_{amb} = 25\text{ °C}$; $I_{CC(tot)} = 450\text{ mA}$; $P_L = 15\text{ dBm}$ per tone;
 $\Delta f = 1\text{ MHz}$; matched for UMTS-2140.
 (1) $V_{SUP} = 4.75\text{ V}$
 (2) $V_{SUP} = 5\text{ V}$
 (3) $V_{SUP} = 5.25\text{ V}$

Fig 31. Third order intermodulation distortion as a function of frequency for UMTS-2140 application; different supply voltages; typical values

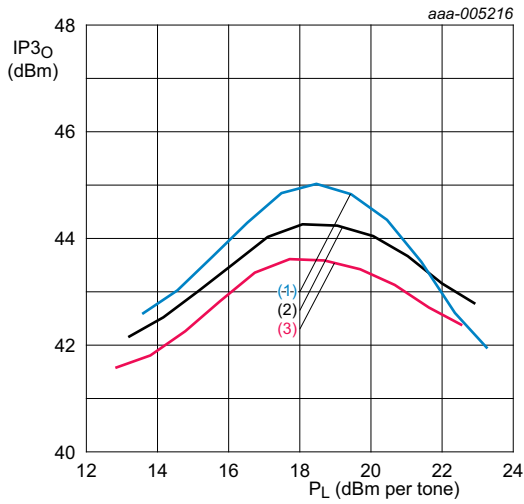

$V_{SUP} = 5\text{ V}$; $I_{CC(tot)} = 450\text{ mA}$; $\Delta f = 1\text{ MHz}$; matched for UMTS-2140.

- (1) $T_{amb} = -40\text{ }^{\circ}\text{C}$
- (2) $T_{amb} = +25\text{ }^{\circ}\text{C}$
- (3) $T_{amb} = +85\text{ }^{\circ}\text{C}$

Fig 32. Third order intermodulation distortion as a function of output power for UMTS-2140 application; different temperatures; typical values

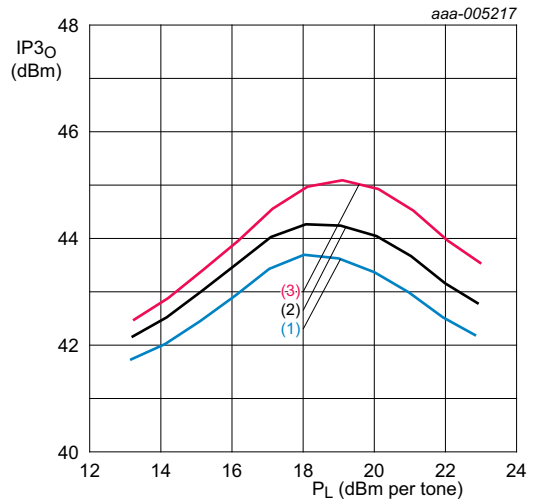

$T_{amb} = 25\text{ }^{\circ}\text{C}$; $I_{CC(tot)} = 450\text{ mA}$; $\Delta f = 1\text{ MHz}$; matched for UMTS-2140.

- (1) $V_{SUP} = 4.75\text{ V}$
- (2) $V_{SUP} = 5\text{ V}$
- (3) $V_{SUP} = 5.25\text{ V}$

Fig 33. Third order intermodulation distortion as a function of output power for UMTS-2140 application; different supply voltages; typical values

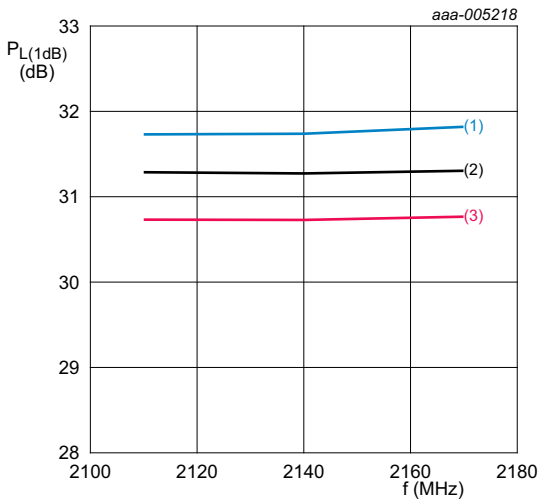

$V_{SUP} = 5\text{ V}$; $I_{CC(tot)} = 450\text{ mA}$; matched for UMTS-2140.

- (1) $T_{amb} = -40\text{ }^{\circ}\text{C}$
- (2) $T_{amb} = +25\text{ }^{\circ}\text{C}$
- (3) $T_{amb} = +85\text{ }^{\circ}\text{C}$

Fig 34. Output power at 1 dB gain compression as a function of frequency for UMTS-2140 application; different temperatures; typical values

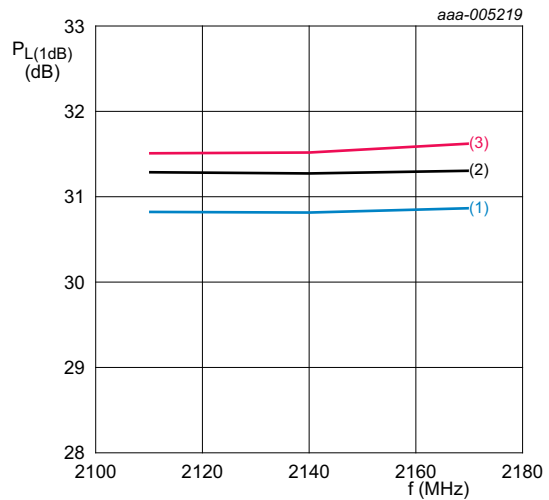

$T_{amb} = 25\text{ }^{\circ}\text{C}$; $I_{CC(tot)} = 450\text{ mA}$; matched for UMTS-2140.

- (1) $V_{SUP} = 4.75\text{ V}$
- (2) $V_{SUP} = 5\text{ V}$
- (3) $V_{SUP} = 5.25\text{ V}$

Fig 35. Output power at 1 dB gain compression as a function of frequency for UMTS-2140 application; different supply voltages; typical values

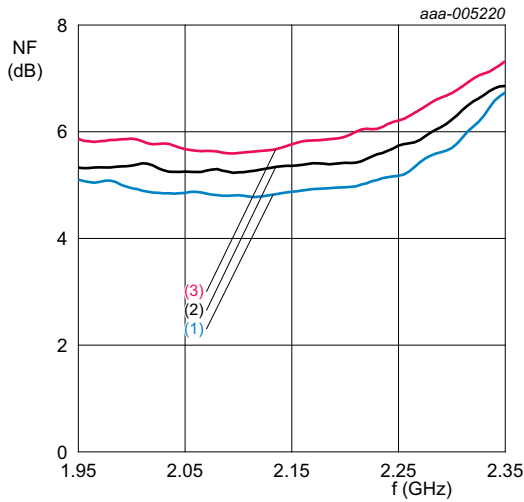

$V_{SUP} = 5\text{ V}$; $I_{CC(tot)} = 450\text{ mA}$; matched for UMTS-2140.
 (1) $T_{amb} = -40\text{ }^{\circ}\text{C}$
 (2) $T_{amb} = +25\text{ }^{\circ}\text{C}$
 (3) $T_{amb} = +85\text{ }^{\circ}\text{C}$

Fig 36. Noise figure as a function of frequency for UMTS-2140 application; different temperatures; typical values

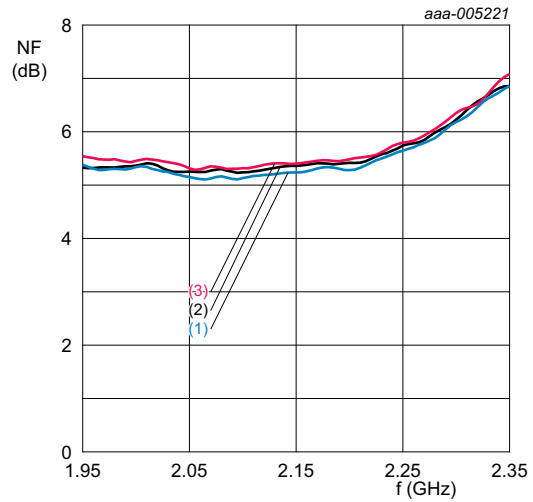

$T_{amb} = 25\text{ }^{\circ}\text{C}$; $I_{CC(tot)} = 450\text{ mA}$; matched for UMTS-2140.
 (1) $V_{SUP} = 4.75\text{ V}$
 (2) $V_{SUP} = 5\text{ V}$
 (3) $V_{SUP} = 5.25\text{ V}$

Fig 37. Noise figure as a function of frequency for UMTS-2140 application; different supply voltages; typical values

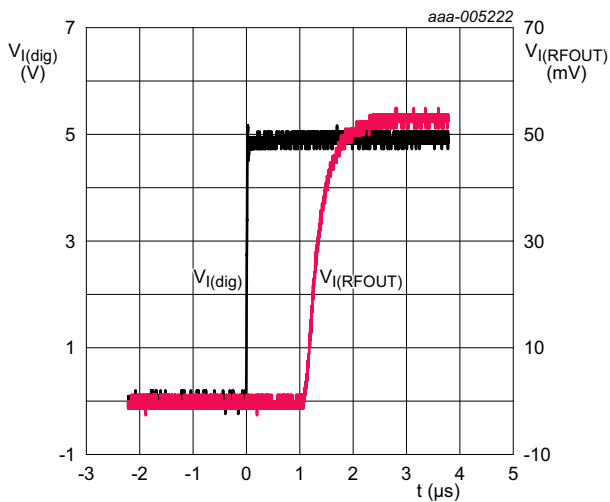

$V_{SUP} = 5\text{ V}$; $I_{CC(tot)} = 450\text{ mA}$; matched for UMTS-2140.

Fig 38. Power-on delay time; typical values

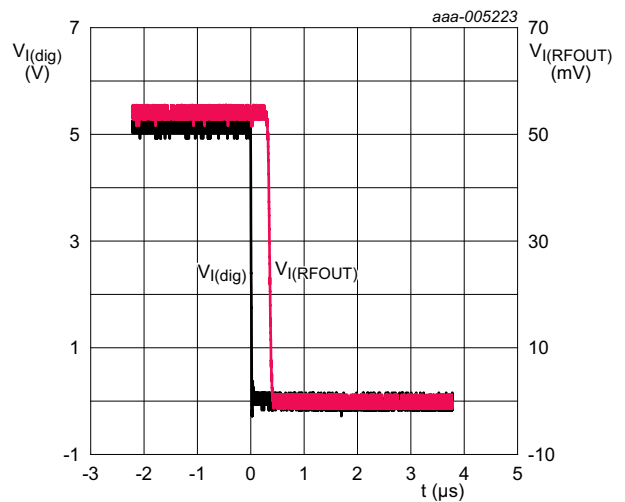

$V_{SUP} = 5\text{ V}$; $I_{CC(tot)} = 450\text{ mA}$; matched for UMTS-2140.

Fig 39. Power-down delay time; typical values

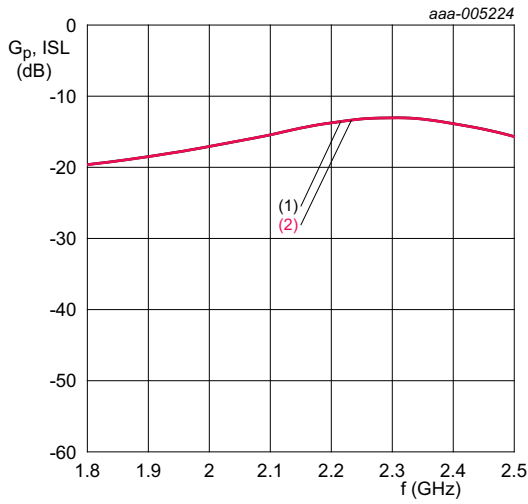

$V_{SUP} = 5\text{ V}$; $I_{CC(tot)} = 450\text{ mA}$; pin ENABLE = LOW; matched for UMTS-2140.

- (1) G_p
- (2) ISL

Fig 40. Isolation in power-down mode; typical values

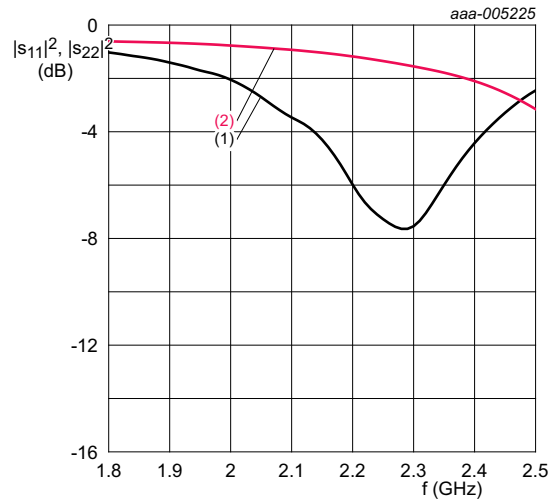

$V_{SUP} = 5\text{ V}$; $I_{CC(tot)} = 450\text{ mA}$; pin ENABLE = LOW; matched for UMTS-2140.

- (1) $|S_{11}|^2$
- (2) $|S_{22}|^2$

Fig 41. Return loss in power-down mode; typical values

15. Package outline

HVSON8: plastic thermal enhanced very thin small outline package; no leads; 8 terminals; body 3 x 3 x 0.85 mm

SOT908-3

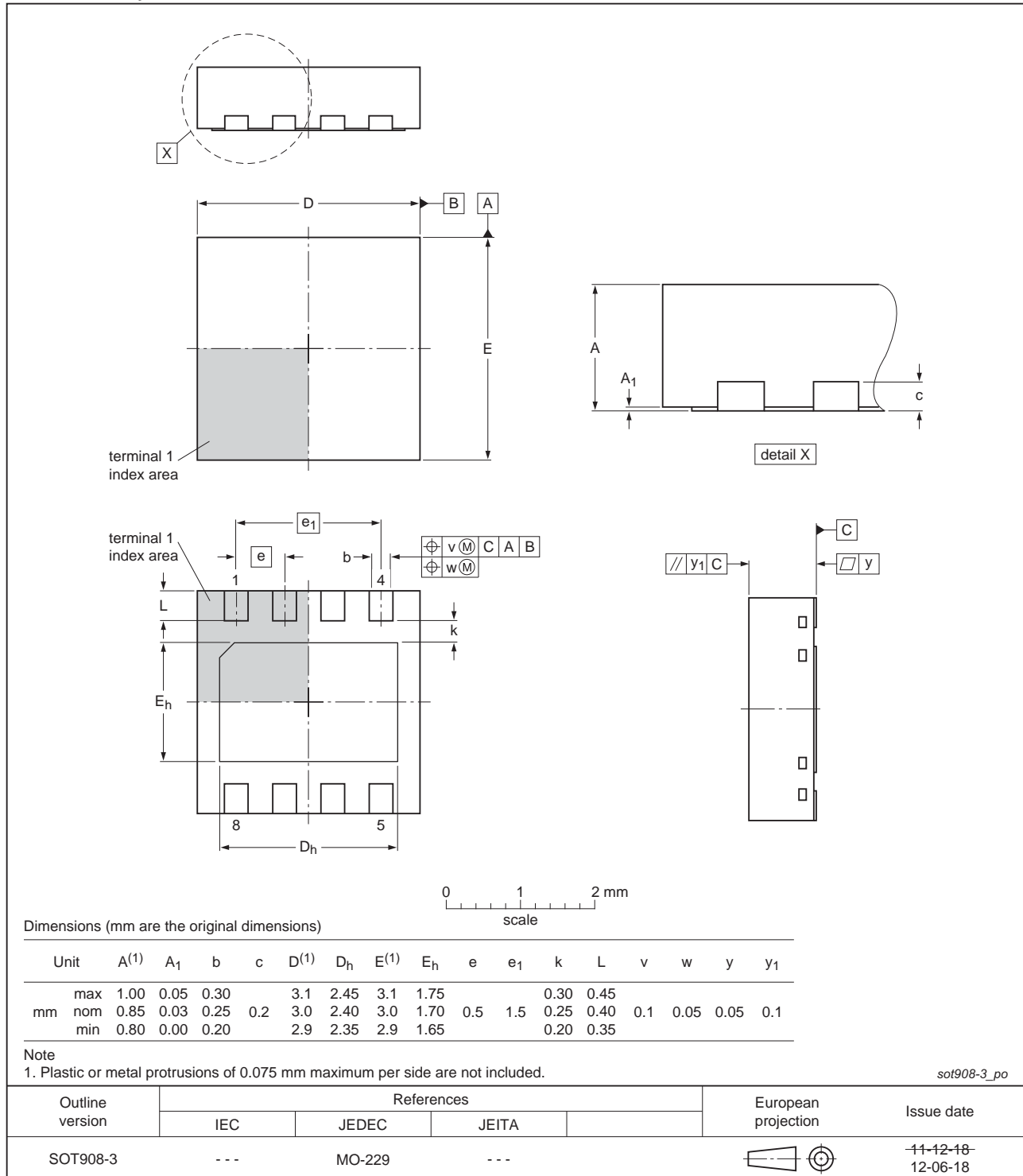
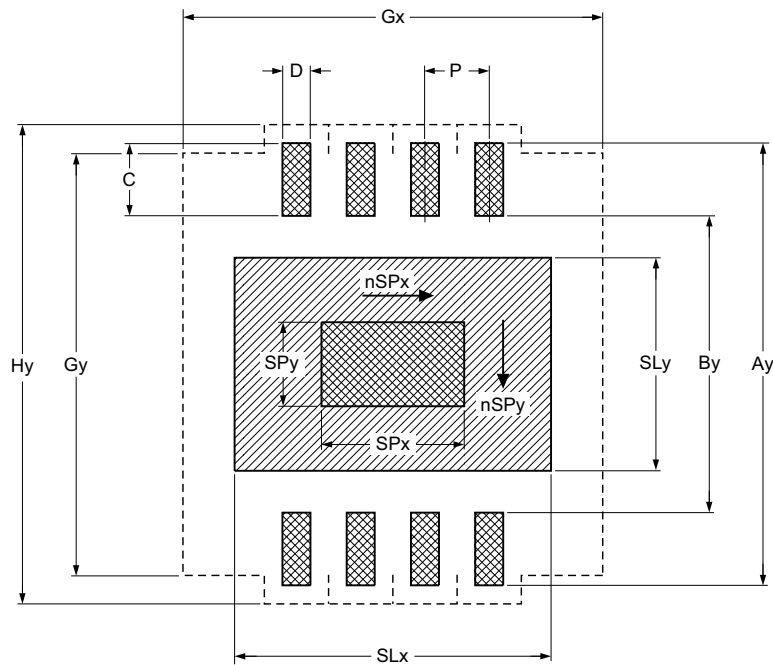





Fig 42. Package outline SOT908-3 (HVSON8)

16. Soldering

Footprint information for reflow soldering of HVSON8 package

SOT908-3



-  solder land
-  solder paste deposit
-  solder land plus solder paste
-  occupied area

DIMENSIONS in mm

P	Ay	By	C	D	SLx	SLy	SPx	SPy	Gx	Gy	Hy
0.5	3.45	2.25	0.6	0.25	2.45	1.65	1.1	0.65	3.25	3.25	3.7

nSPx	nSPy
1	1

Issue date 12-07-03
12-07-12

sot908-3_fr

Fig 43. Reflow soldering footprint

17. Abbreviations

Table 13. Abbreviations

Acronym	Description
CDM	Charged Device Model
CPE	Customer-Premises Equipment
ESD	ElectroStatic Discharge
E-UTRA	Evolved Universal Terrestrial Radio Access
eUTRAN	evolved UMTS Terrestrial Radio Access Network
HBM	Human Body Model
ISM	Industrial, Scientific and Medical
LTE	Long Term Evolution
MMIC	Monolithic Microwave Integrated Circuit
MoCA	Multimedia over Coax Alliance
PAR	Peak-to-Average power Ratio
RFID	Radio Frequency IDentification
SMA	Sub-Miniature version A
UMTS	Universal Mobile Telecommunications System
VSWR	Voltage Standing-Wave Ratio
W-CDMA	Wideband Code Division Multiple Access
WLAN	Wireless Local Area Network

18. Revision history

Table 14. Revision history

Document ID	Release date	Data sheet status	Change notice	Supersedes
BGA7130 v.1	20121009	Product data sheet	-	-

19. Legal information

19.1 Data sheet status

Document status ^{[1][2]}	Product status ^[3]	Definition
Objective [short] data sheet	Development	This document contains data from the objective specification for product development.
Preliminary [short] data sheet	Qualification	This document contains data from the preliminary specification.
Product [short] data sheet	Production	This document contains the product specification.

[1] Please consult the most recently issued document before initiating or completing a design.

[2] The term 'short data sheet' is explained in section "Definitions".

[3] The product status of device(s) described in this document may have changed since this document was published and may differ in case of multiple devices. The latest product status information is available on the Internet at URL <http://www.nxp.com>.

19.2 Definitions

Draft — The document is a draft version only. The content is still under internal review and subject to formal approval, which may result in modifications or additions. NXP Semiconductors does not give any representations or warranties as to the accuracy or completeness of information included herein and shall have no liability for the consequences of use of such information.

Short data sheet — A short data sheet is an extract from a full data sheet with the same product type number(s) and title. A short data sheet is intended for quick reference only and should not be relied upon to contain detailed and full information. For detailed and full information see the relevant full data sheet, which is available on request via the local NXP Semiconductors sales office. In case of any inconsistency or conflict with the short data sheet, the full data sheet shall prevail.

Product specification — The information and data provided in a Product data sheet shall define the specification of the product as agreed between NXP Semiconductors and its customer, unless NXP Semiconductors and customer have explicitly agreed otherwise in writing. In no event however, shall an agreement be valid in which the NXP Semiconductors product is deemed to offer functions and qualities beyond those described in the Product data sheet.

19.3 Disclaimers

Limited warranty and liability — Information in this document is believed to be accurate and reliable. However, NXP Semiconductors does not give any representations or warranties, expressed or implied, as to the accuracy or completeness of such information and shall have no liability for the consequences of use of such information. NXP Semiconductors takes no responsibility for the content in this document if provided by an information source outside of NXP Semiconductors.

In no event shall NXP Semiconductors be liable for any indirect, incidental, punitive, special or consequential damages (including - without limitation - lost profits, lost savings, business interruption, costs related to the removal or replacement of any products or rework charges) whether or not such damages are based on tort (including negligence), warranty, breach of contract or any other legal theory.

Notwithstanding any damages that customer might incur for any reason whatsoever, NXP Semiconductors' aggregate and cumulative liability towards customer for the products described herein shall be limited in accordance with the *Terms and conditions of commercial sale* of NXP Semiconductors.

Right to make changes — NXP Semiconductors reserves the right to make changes to information published in this document, including without limitation specifications and product descriptions, at any time and without notice. This document supersedes and replaces all information supplied prior to the publication hereof.

Suitability for use — NXP Semiconductors products are not designed, authorized or warranted to be suitable for use in life support, life-critical or safety-critical systems or equipment, nor in applications where failure or malfunction of an NXP Semiconductors product can reasonably be expected to result in personal injury, death or severe property or environmental damage. NXP Semiconductors and its suppliers accept no liability for inclusion and/or use of NXP Semiconductors products in such equipment or applications and therefore such inclusion and/or use is at the customer's own risk.

Applications — Applications that are described herein for any of these products are for illustrative purposes only. NXP Semiconductors makes no representation or warranty that such applications will be suitable for the specified use without further testing or modification.

Customers are responsible for the design and operation of their applications and products using NXP Semiconductors products, and NXP Semiconductors accepts no liability for any assistance with applications or customer product design. It is customer's sole responsibility to determine whether the NXP Semiconductors product is suitable and fit for the customer's applications and products planned, as well as for the planned application and use of customer's third party customer(s). Customers should provide appropriate design and operating safeguards to minimize the risks associated with their applications and products.

NXP Semiconductors does not accept any liability related to any default, damage, costs or problem which is based on any weakness or default in the customer's applications or products, or the application or use by customer's third party customer(s). Customer is responsible for doing all necessary testing for the customer's applications and products using NXP Semiconductors products in order to avoid a default of the applications and the products or of the application or use by customer's third party customer(s). NXP does not accept any liability in this respect.

Limiting values — Stress above one or more limiting values (as defined in the Absolute Maximum Ratings System of IEC 60134) will cause permanent damage to the device. Limiting values are stress ratings only and (proper) operation of the device at these or any other conditions above those given in the Recommended operating conditions section (if present) or the Characteristics sections of this document is not warranted. Constant or repeated exposure to limiting values will permanently and irreversibly affect the quality and reliability of the device.

Terms and conditions of commercial sale — NXP Semiconductors products are sold subject to the general terms and conditions of commercial sale, as published at <http://www.nxp.com/profile/terms>, unless otherwise agreed in a valid written individual agreement. In case an individual agreement is concluded only the terms and conditions of the respective agreement shall apply. NXP Semiconductors hereby expressly objects to applying the customer's general terms and conditions with regard to the purchase of NXP Semiconductors products by customer.

No offer to sell or license — Nothing in this document may be interpreted or construed as an offer to sell products that is open for acceptance or the grant, conveyance or implication of any license under any copyrights, patents or other industrial or intellectual property rights.

Export control — This document as well as the item(s) described herein may be subject to export control regulations. Export might require a prior authorization from competent authorities.

Quick reference data — The Quick reference data is an extract of the product data given in the Limiting values and Characteristics sections of this document, and as such is not complete, exhaustive or legally binding.

Non-automotive qualified products — Unless this data sheet expressly states that this specific NXP Semiconductors product is automotive qualified, the product is not suitable for automotive use. It is neither qualified nor tested in accordance with automotive testing or application requirements. NXP Semiconductors accepts no liability for inclusion and/or use of non-automotive qualified products in automotive equipment or applications.

In the event that customer uses the product for design-in and use in automotive applications to automotive specifications and standards, customer (a) shall use the product without NXP Semiconductors' warranty of the

product for such automotive applications, use and specifications, and (b) whenever customer uses the product for automotive applications beyond NXP Semiconductors' specifications such use shall be solely at customer's own risk, and (c) customer fully indemnifies NXP Semiconductors for any liability, damages or failed product claims resulting from customer design and use of the product for automotive applications beyond NXP Semiconductors' standard warranty and NXP Semiconductors' product specifications.

Translations — A non-English (translated) version of a document is for reference only. The English version shall prevail in case of any discrepancy between the translated and English versions.

19.4 Trademarks

Notice: All referenced brands, product names, service names and trademarks are the property of their respective owners.

20. Contact information

For more information, please visit: <http://www.nxp.com>

For sales office addresses, please send an email to: salesaddresses@nxp.com

21. Contents

1 **General description** 1

2 **Features and benefits** 1

3 **Applications** 1

4 **Quick reference data** 1

5 **Design support** 2

6 **Ordering information** 3

7 **Functional diagram** 3

8 **Pinning information** 4

8.1 Pinning 4

8.2 Pin description 4

9 **Functional description** 5

9.1 Supply current adjustment 5

9.2 Enable control 5

10 **Limiting values** 5

11 **Thermal characteristics** 6

12 **Static characteristics** 6

13 **Dynamic characteristics** 7

14 **Application information** 8

14.1 Application board 9

14.2 Characteristics LTE-750 13

14.3 Characteristics UMTS-2140 17

15 **Package outline** 22

16 **Soldering** 23

17 **Abbreviations** 24

18 **Revision history** 24

19 **Legal information** 25

19.1 Data sheet status 25

19.2 Definitions 25

19.3 Disclaimers 25

19.4 Trademarks 26

20 **Contact information** 26

21 **Contents** 27

Please be aware that important notices concerning this document and the product(s) described herein, have been included in section 'Legal information'.