



Part No: DTS240050SUDC-P5P-SZ

Date: 4/07/2006

Unit: mm

Description: switching power supply

Page No: 1 of 7

## Input

Rated input voltage	100 V ~ 240 V ac
Input voltage range	90 V ~ 264 V ac
Rated frequency	50~60 Hz
Frequency range	47~63 Hz
Rated input current	300 mA RMS max.
Inrush current	30 A max. at 115 / 50 A max. at 230 V ac cool start

## Output

Output voltage	24 V dc at 0.5 A
Output min. current	0 A
Line regulation	± 1%
Load regulation	± 5%
Over voltage protection	25.6 ~ 28.3 V dc max. (output shut down)
Short circuit protection	output shut down and auto restart
Ripple voltage	240 mV (p-p) (100~240 V ac at full load)
Efficiency	65% min.

## Safety and EMI

HI-POT	input to output	3000 V ac or 4242 V dc at 10 mA for 1 min.
Insulation resistance	input to output	> 100 M Ohm at 500 V dc
Safety approvals	UL/cUL, S/GS, CE	
EMI standard	meets FCC class B, CE, VCCI-II	
RoHS compliant	yes	
Leakage current	0.25 mA	

## Environmental

Storage temperature	-10°C ~ +70° C
Operating temperature	0°C ~ +40° C
Storage humidity	10~90%
Operating humidity	20~80%



**Label**

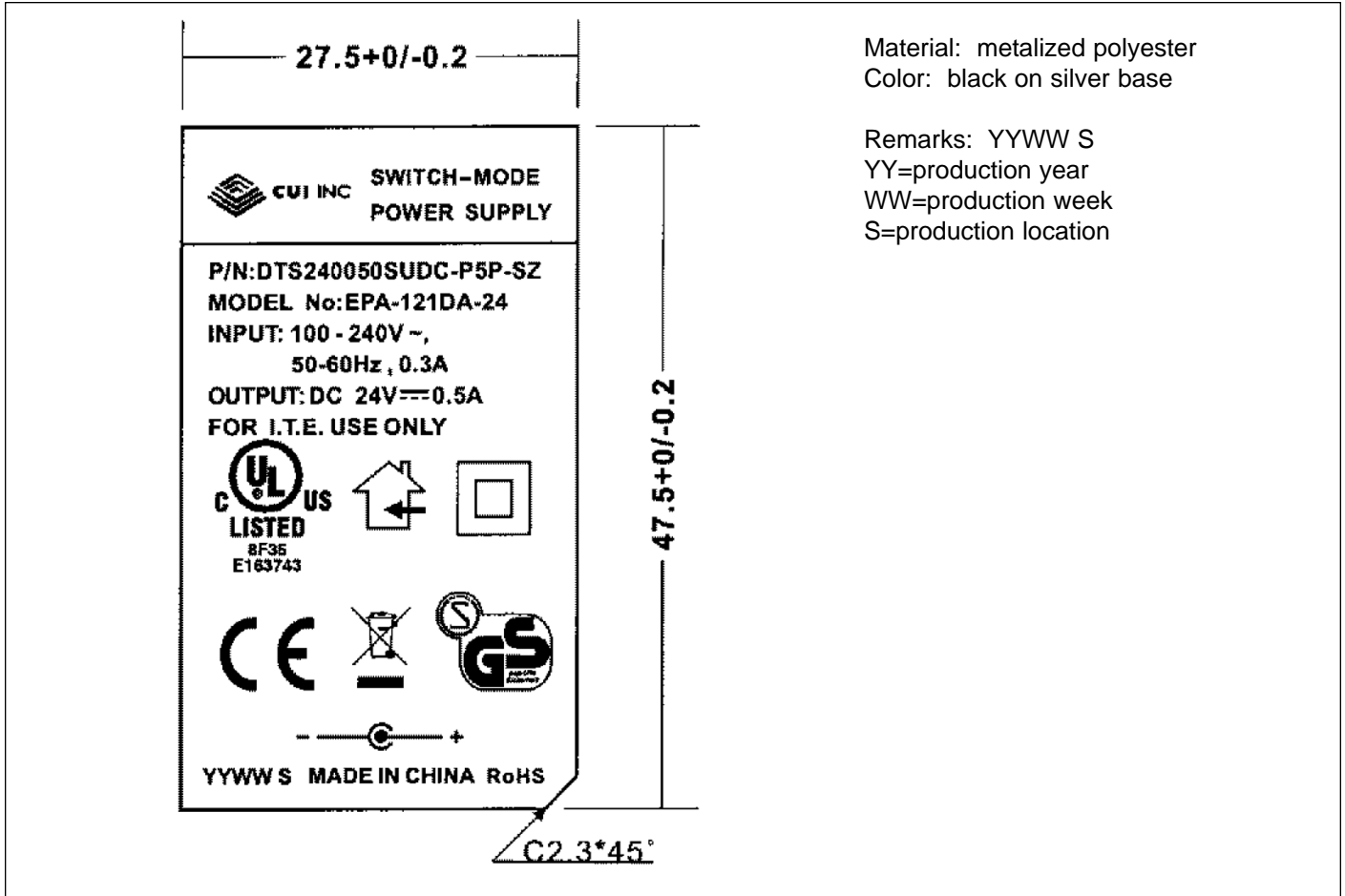

**Mechanical Drawing**

 Tolerance:  $\pm 1$ 

Input plug

Inlet IEC320/C8-2 Type

Case size

75 L x 47.5 W x 26.5 H mm

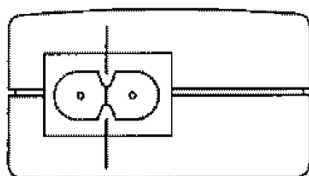
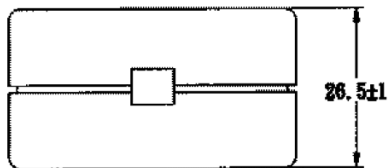
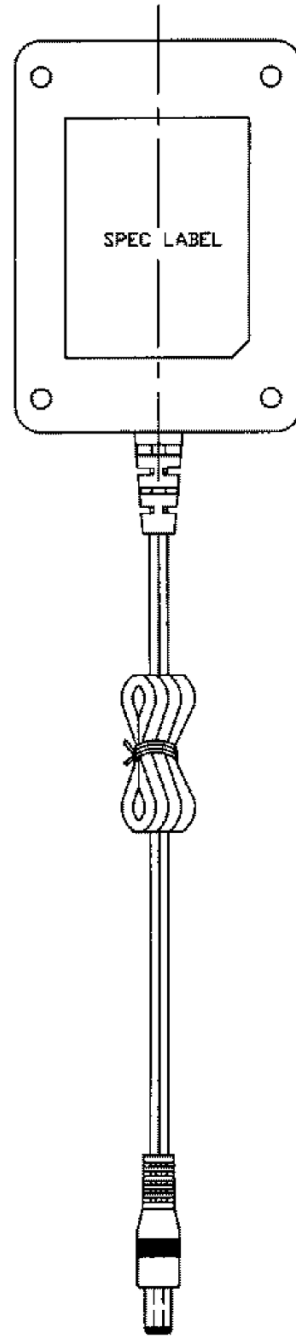
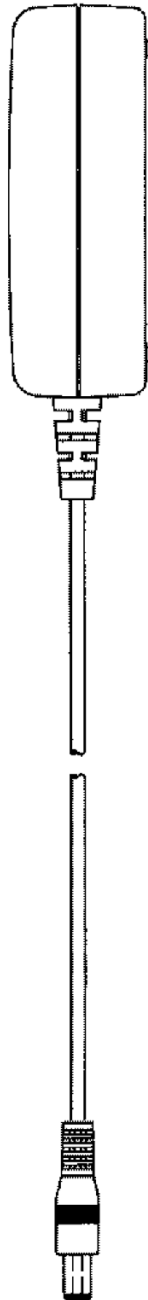
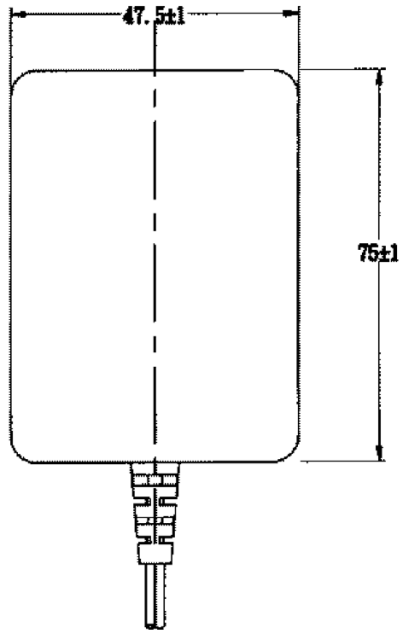



DC Cord

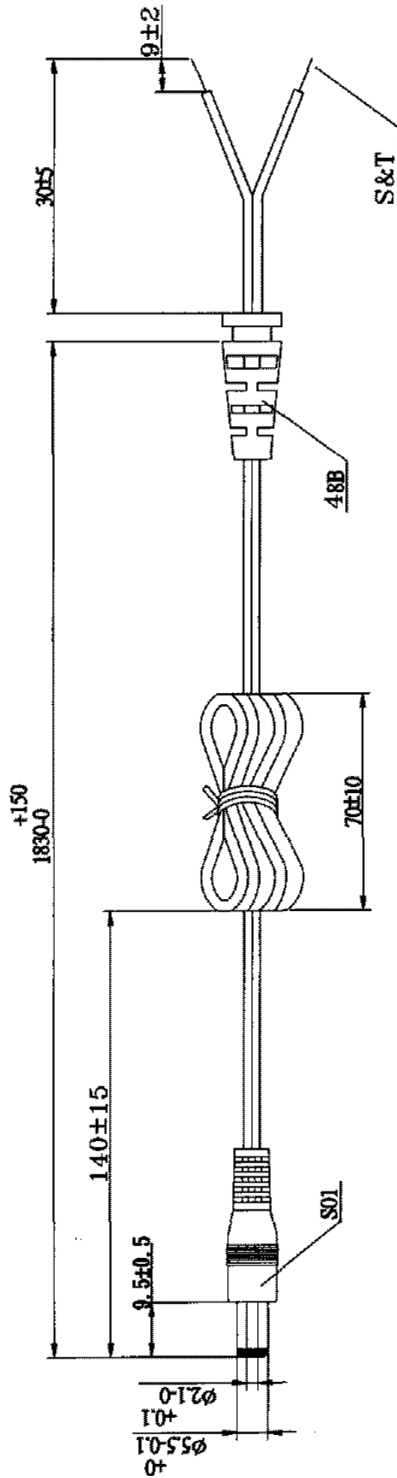

HAVE ON WORD WIRE IN OUTER, NO WORD WIRE IN INNER

#24AWG X2C UL2468

OD: Ø1.5X3.0



VIBRATION TEST	a. 150"
	b. WEIGHT 200g
	c. 40 ROUND/MINUTE
	d. OVER 1000 COUNT MIN



AC Cord

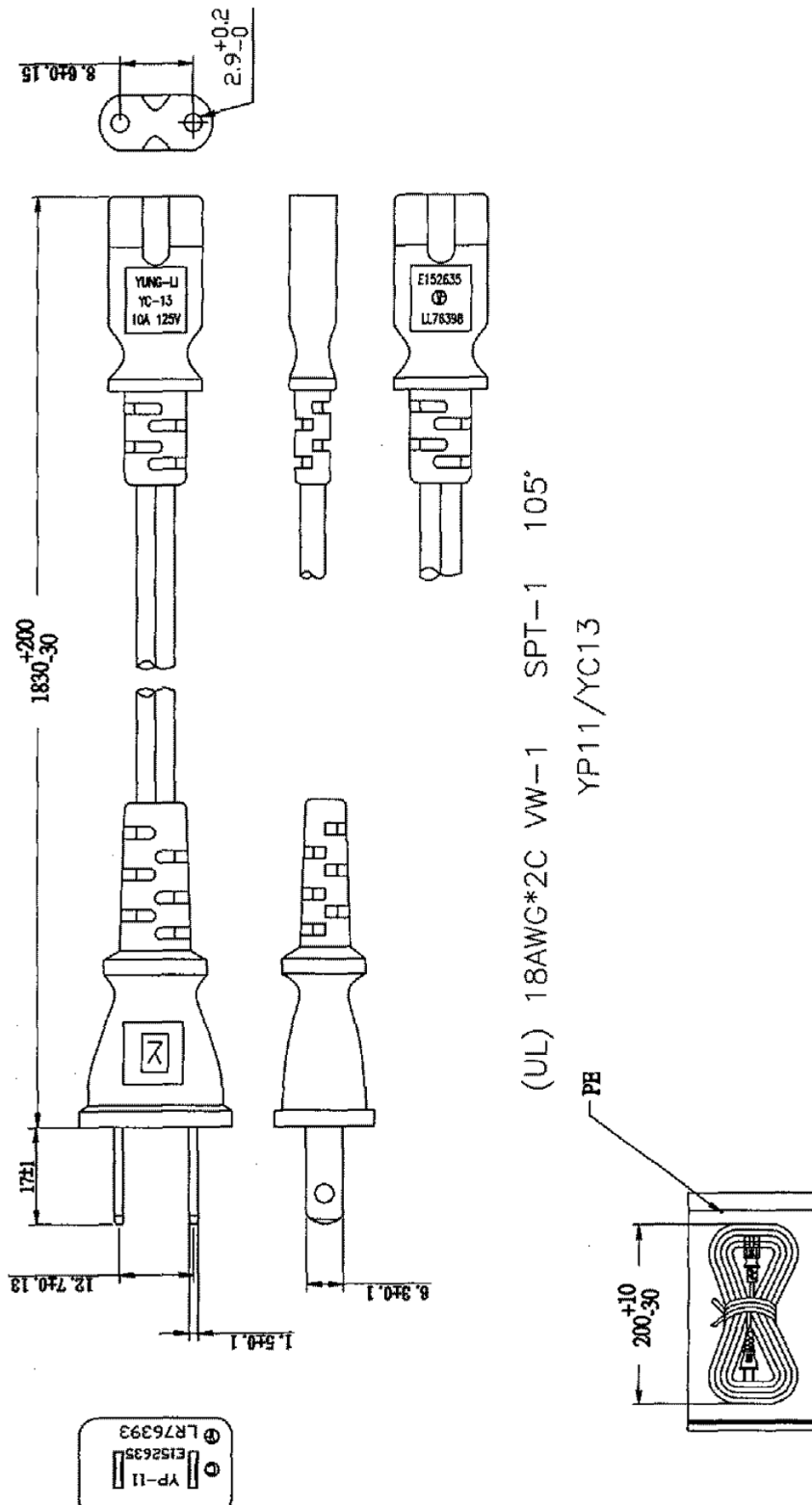



**Individual Packaging**

Tolerance:  $\pm 1$

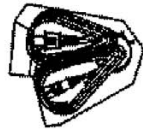

← AC CORD

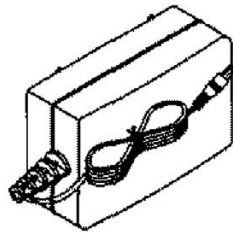

← product

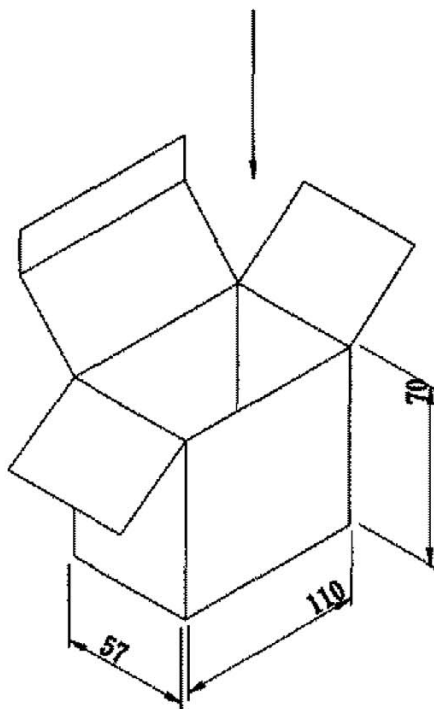

← "RoHS Compliant"



**CUI INC**

Part No: DTS240050SUDC-P5P-SZ

Date: 4/07/2006

Unit: mm

Description: switching power supply

Page No: 7 of 7

### Packaging

Tolerance: +7/-0

CARTON SIZE: 450\*295\*220mm

Q'TY: 60PCS(20\*3)

"RoHS Compliant"

