

PREPARED BY: <i>T. Ueda</i>	DATE: <i>Jun 16/99</i>	<h1>SHARP</h1> <p>ELECTRONIC COMPONENTS GROUP SHARP CORPORATION</p> <h2>SPECIFICATION</h2>	SPEC.No. DG996036
APPROVED BY: <i>F. Fukase</i>	DATE: <i>Jun 16/99</i>		ISSUE Jun/16/99
			PAGE 10 pages
			REPRESENTATIVE DIVISION: Opto-Electronic Devices Division

DEVICE SPECIFICATION FOR

Light Emitting Diode

MODEL No. **GL5ZJ43**

- These specification sheets include materials protected under the copyright of Sharp Corporation ("Sharp"). Please do not reproduce or cause anyone to reproduce them without Sharp's consent.
- When using this product, please observe the absolute maximum ratings and the instructions for use outlined in these specification sheets, as well as the precautions mentioned below. Sharp assumes no responsibility for any damage resulting from use of the product which does not comply with the absolute maximum ratings and the instructions included in these specification sheets, and the precautions mentioned below.

(Precautions)

 - This products is designed for use in the following application areas;

<ul style="list-style-type: none"> * OA equipment * Telecommunication equipment (Terminal) * Tooling machines 	<ul style="list-style-type: none"> * Audio visual equipment * Measuring equipment * Computers 	<ul style="list-style-type: none"> * Home appliance
--	--	--

If the use of the product in the above application areas is for equipment listed in paragraphs (2) or (3), please be sure to observe the precautions given in those respective paragraphs.
 - Appropriate measures, such as fail-safe design and redundant design considering the safety design of the overall system and equipment, should be taken to ensure reliability and safety when this product is used for equipment which demands high reliability and safety in function and precision, such as ;

<ul style="list-style-type: none"> * Transportation control and safety equipment (aircraft, train, automobile etc.) * Other safety equipment 	<ul style="list-style-type: none"> * Traffic signals * Gas leakage sensor breakers 	<ul style="list-style-type: none"> * Rescue and security equipment
--	--	---
 - Please do not use this product for equipment which require extremely high reliability and safety in function and precision, such as ;

<ul style="list-style-type: none"> * Space equipment * Nuclear power control equipment 	<ul style="list-style-type: none"> * Telecommunication equipment (for trunk lines) * Medical equipment
--	--
 - Please contact and consult with a Sharp sales representative if there are any questions regarding interpretation of the above three paragraphs.
- Please contact and consult with a Sharp sales representative for any questions about this product.

CUSTOMER'S APPROVAL

DATE: _____

BY: _____

DATE: *Jun 18/1999*
PRESENTED BY: *M. Katoh*

M.Katoh,
Department General Manager of
Engineering Dept.,III
Opto-Electronic Devices Division
Electronic Components Group
SHARP CORPORATION

DG996036	Jun/16/99
MODEL No.	PAGE
GL5ZJ43	1/10

SHARP

GL5ZJ43 Specification

1. Application

This specification applies to the light emitting diode device Model No. GL5ZJ43.

[AlGaInP (dicing or scribe/brake type) Orange LED device]

2. Outline dimensions and pin connections Refer to the attached sheet Page 2.

3. Ratings and characteristics Refer to the attached sheet Page 3~4.

3-1. Absolute maximum ratings

3-2. Electro-optical characteristics

3-3. Derating Curve

3-4. Characteristics Diagram

4. Reliability Refer to the attached sheet Page 5.

4-1. Test items and test conditions

4-2. Measurement items and Failure judgement criteria

5. Incoming inspection Refer to the attached sheet Page 6.

5-1. Applied standard

5-2. Sampling method and level

5-3. Test items, judgement criteria and classifica of defect

5-4. Test items the surface is be applied for flat type, judgement criteria and classifica of defect

6. Supplement Refer to the attached sheet Page 7~8.

6-1. Packing

6-2. Luminous intensity rank

6-3. Dominant wavelength rank

6-4. Environment

7. Precautions for use Refer to the attached sheet Page 9~10.

7-1. Lead forming method

7-2. Notice of installation

7-3. Soldering Conditions

7-4. For cleaning



2. Outline dimensions and pin connections

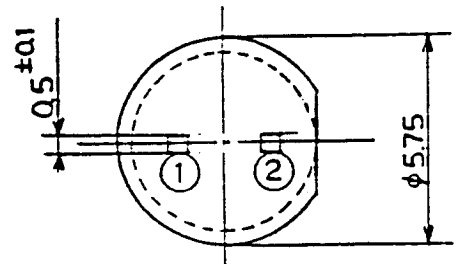
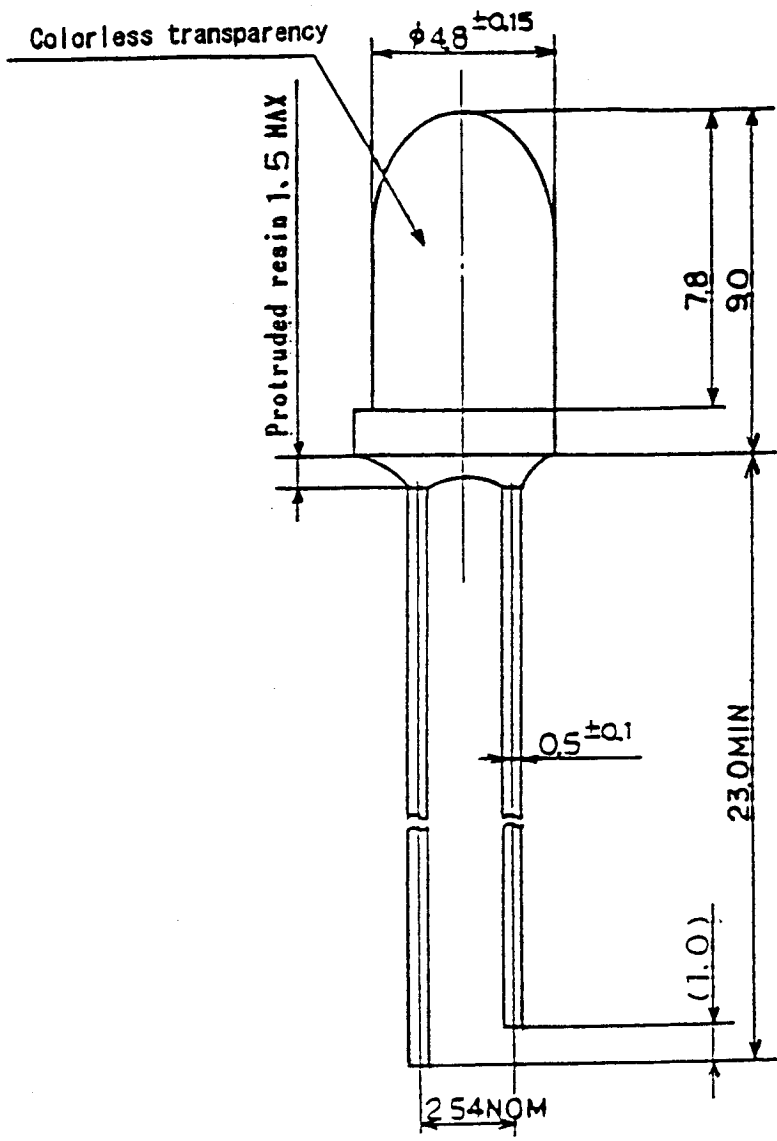

Pin connections
 ①. Anode
 ②. Cathode

(Note) Unspecified tol. to be $\pm 0.2\text{mm}$

(Note) Cold rolled steel leads are plated with but the tie-bar cut portions have no plating do not solder this part of the product.

Unit	Material	Finish	Drawing No.
mm	Lead : (Fe) Cold rolled steel Package : Epoxy resin	Lead : Sn plated or wave soldering	5 1 1 0 6 0 1 7



3. Ratings and characteristics

3-1. Absolute maximum ratings

(Ta=25°C)

Parameter	Symbol	Value	Unit	
Power dissipation	P	130	mW	
Continuous forward current	I _F	50	mA	
Peak forward current(Note 1)	I _{FM}	100	mA	
Derating factor	DC	-	0.67	mA/°C
	Pulse	-	1.33	mA/°C
Reverse voltage	V _R	5	V	
Operating temperature	Topr	-40 ~ 85	°C	
Storage temperature	Tstg	-40 ~ 100	°C	
Soldering temperature(Note 2)	Tsol	260 (within 5 seconds)	°C	

(Note 1) Duty ratio=1/10,Pulse width=0.1ms

(Note 2) At the position of 1.6mm from the bottom resin package

3-2. Electro-optical characteristics

(Ta=25°C)

Parameter	Symbol	Conditions	MIN.	TYP.	MAX.	Unit
Forward voltage	V _F	IF=20mA	-	2.1	2.6	V
Luminous intensity (Note 3)	I _v		3417	8000	-	mcd
Peak emission wavelength	λ _p		-	627	-	nm
Dominant wavelength	λ _d		-	618	-	nm
Spectrum radiation bandwidth	Δλ		-	15	-	nm
Reverse current	I _R	VR=4V	-	-	100	μA
Terminal capacitance	C _t	V=0V,f=1MHz	-	60	-	pF
Viewing Angle	2θ 1/2	IF=20mA	-	8	-	deg.

(Note 3) Refer to the supplement item 6. regarding the standard of rank classification.

3-3. Derating Curve

Peak Forward Current Derating Curve

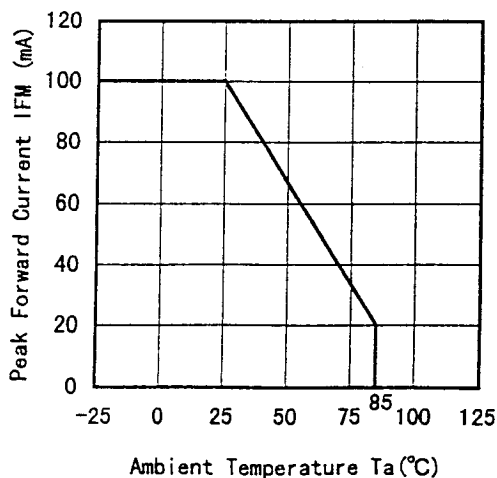

Forward Current Derating Curve

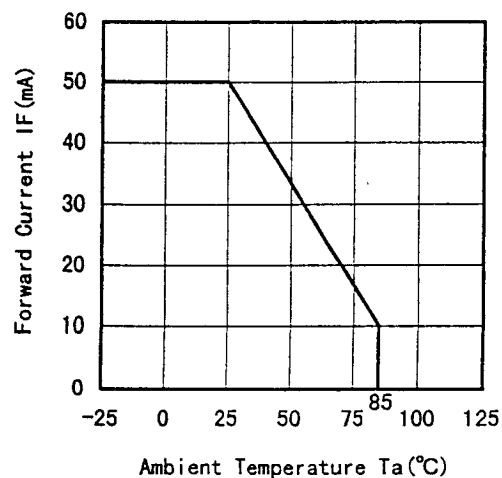

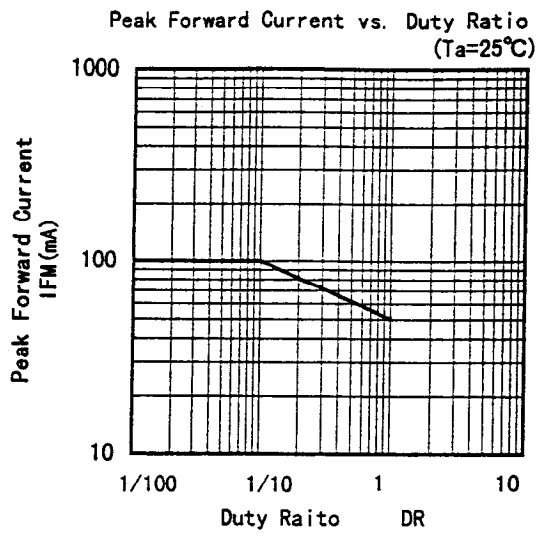

3-4. Characteristics Diagram(typ) (Note 1)

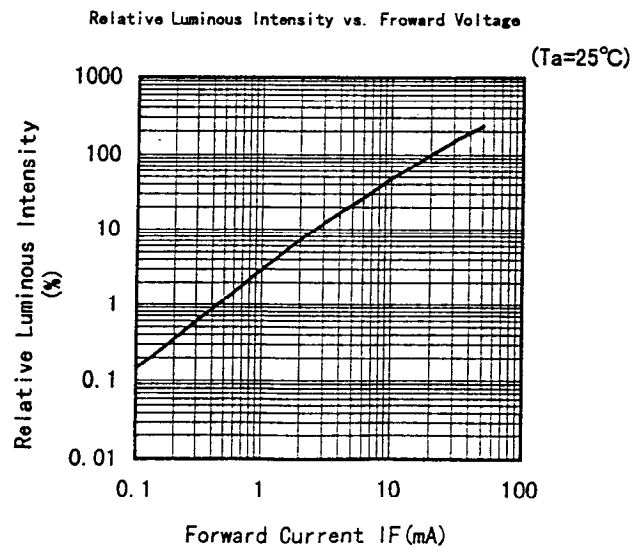
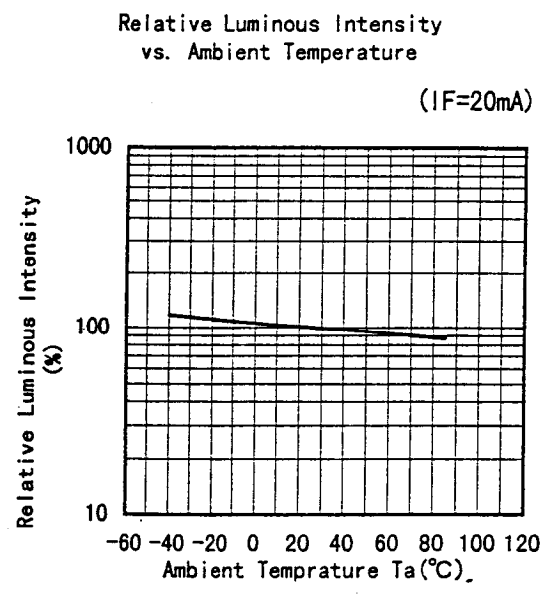
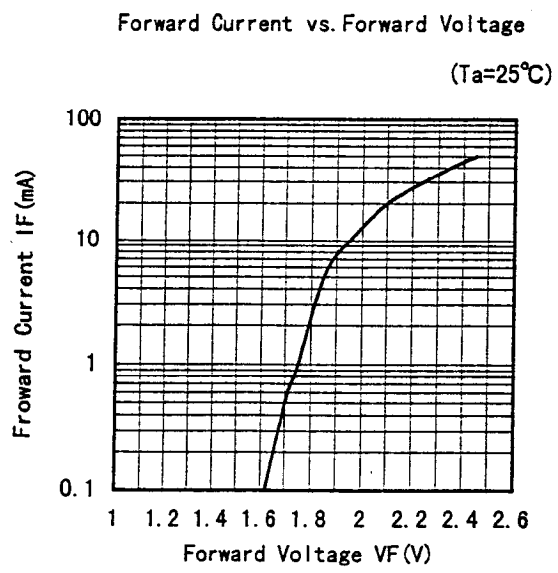

(Note 1) Above characteristic data are typical data and not a guaranteed data.

SHARP

4. Reliability

The reliability of products shall be satisfied with items listed below.

4-1. Test items and test conditions

Confidence level: 90%

Test items	Test conditions	Samples (n) Defective (C)	LTPD (%)
Solderability	230±5°C, 5s Prior disposition : Dip in rosin flux	n=11, C=0	20
Soldering temperature	260±5°C, 5s	n=11, C=0	20
Mechanical shock	15 000m/s ² , 0.5ms, 3times / ±X,±Y,±Z direction	n=11, C=0	20
Variable frequency vibration	200m/s ² , 100 to 2 000 to 100Hz/sweep for 4min. ,4times/±X,±Y,±Z direction	n=11, C=0	20
Terminal strength (Tension)	Weight:10N, 5s/ each terminal	n=11, C=0	20
Terminal strength (Bending)	Weight:5N, 0° → 90° → 0° → -90° → 0° / each terminal	n=11, C=0	20
Temperature cycling	-40°C(30min)~+100°C(30min),30 cycles	n=22, C=0	10
High temp. and high humidity storage	Ta=+60°C, 90%RH, t=1000h	n=22, C=0	10
High temperature storage	Ta=100°C, t=1000h	n=22, C=0	10
Low temperature storage	Ta=-40°C, t=1000h	n=22, C=0	10
Operation life	Ta=25°C, I _F MAX, t=1000h *3	n=22, C=0	10

4-2. Measurement items and Failure judgement criteria *1

Measurement	Symbol	Failure judgement criteria *2
Forward voltage	V _F	V _F > U.S.L. × 1.2
Reverse current	I _R	I _R > U.S.L. × 2.0
Luminous intensity	I _v	I _v > The first stage value × 2.0 or The first stage value × 0.5 > I _v

※ Solderability : Solder shall be adhere at the area of 95% or more of dipped portion.

※ Terminal strength : Package is not destroyed, and terminal is not slack.

*1: Measuring condition is in accordance with specification.

*2: U.S.L. is shown by Upper Specification Limit.

*3: I_F MAX.is shown by forward current of absolute maximum ratings.

SHARP

5. Incoming inspection

5-1. Applied standard : ISO 2859-1

5-2. Sampling method and level : A single sampling plan, normal inspection level II
 : AQL Major defect : 0.065%
 Minor defect : 0.4%

5-3. Test items, judgement criteria and classifica of defect

No.	Test items	judgement criteria	classifica of defect
1	Disconnection	Not emit light	Major defect
2	Position of Cutting off rim	Different from dimension	
3	Reverse terminal	Different from dimension	
4	Outline dimensions	Not satisfy outline specification	Minor defect
5	Characteristics	Over the limit value of specification at V_F , I_R , and I_V	
6	Cut off the rim	Exceed -0.2mm	
7	Foreign substance	White point : Exceed ϕ 0.3mm (on top view) Black point : Exceed ϕ 0.3mm (on top view) String form : Exceed 3.0mm (on top view)	
8	Scratch	Exceed ϕ 0.3mm or 0.1mm \times 1.0mm (on top view)	
9	Void	Exceed ϕ 0.3mm (on top view)	
10	Uneven density of material for scattering	Extremely uneven density	
11	Unbalanced center	Exceed \pm 0.25mm from package center	
12	Burr	Exceed +0.2mm against provided dimension	
13	Insertion position of terminal	Insertion position of terminal	

5-4. Test items the surface is be applied for flat type, judgement criteria and classifica of defect

No.	Test items	judgement criteria	classifica of defect
14	Chapped the surface	The surface chapped is striking for see the lamp top	Minor defect
15	Hollow the surface	The surface hollow is striking for see the lamp top	

SHARP

6. Supplement

6-1. Packing

6-1-1. Inner package

Put 250pcs the same luminous intensity rank products into pack and put following label by pack.

Product weight : 0.28g (One Product, Typ.)

(Indication label sample)

SHIPMENT TABLE		
PART No.	GL5ZJ43	← Model number
QUANTITY	250	← Quantity of products
LOT No.	KA99B19	← Lot number *
	<input type="checkbox"/> - <input type="checkbox"/>	← Luminous intensity rank
	S H A R P	← dominant wavelength rank
	MADE IN JAPAN	← Production country

* <input type="checkbox"/>	<input type="checkbox"/>	<input type="checkbox"/>	<input type="checkbox"/>	<input type="checkbox"/>	<input type="checkbox"/>
①	②	③	④	⑤	

- ① Production plant code(to be indicated alphabetically)
- ② Support code
- ③ Year of production(the last two figures of the year)
- ④ Month of production (to be indicated alphabetically with January corresponding to A)
- ⑤ Date of production(01~31)

6-1-2. Outer package

Put 8 packs (the same luminous intensity rank) into outer package.

(approximately 670g per one outer package)

6-1-3. Outer package out line dimension

Width : 140mm, Depth : 225mm, Hight : 90mm

6-2.Luminous intensity rank (Note 1)

(Ta=25°C)

Rank	Luminous intensity		Unit	Condition
Q	3417	~ 6657	mcd	I _F =20mA
R	4920	~ 9586		
S	7085	~ 13803		
T	10203	~ (19877)		

(Note 1) Tolerance:±15%

In regard to luminous intensity , the following ranking shall be carried out.

However the quantity of each rank shall not be pre scribed.

In case of the distribution of the luminous intensity shift to high, at that point new upper rank is prescribed and lower rank is delete.

6-3.Dominant wavelength rank (Note 2)

(Ta=25°C)

Rank	Dominant wavelength		Unit	Condition
T	613.5	~ 617.0	nm	I _F =20mA
U	616.0	~ 619.5		
V	618.5	~ 622.0		
W	621.0	~ 624.5		
X	623.5	~ 627.0		

(Note 2) The condition of measurement : The measurement of the light emission from the front side of lamp.

This rank value is the setting value of when that classifies it the rank and be not a guarantee value.

Also I shall not ask the delivery ratio of each rank.

DG996036	Jun/16/99
MODEL No.	PAGE
GL5ZJ43	8/10

SHARP

6-4. Environment

6-4-1. Ozonosphere destructive chemicals.

- (1) The device doesn't contain following substance.
- (2) The device doesn't have a production line whose process requires following substance.
Restricted part: CFCs,halones,CCl₄,Trichloroethane(Methychloroform)

6-4-2. Bromic non-burning materials

The device doesn't contain bromic non-burning materials(PBBOs,PBBs)

SHARP

7. Precautions for use

7-1. Lead forming method

Avoid forming a lead pin with the lead pin base as a fulcrum: be sure to hold a lead pin firmly when forming. Lead pins should be formed before soldering.

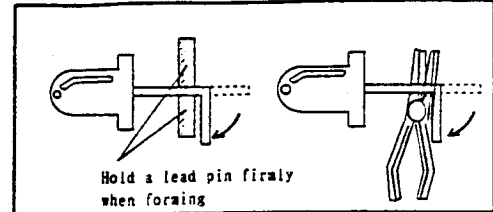

7-2. Notice of installation

7-2-1 installation on a PWB

When mounting an LED lamp on a PWB, do not apply physical stress to the lead pins.

- The lead pin pitch should match the PWB pin-hole pitch: absolutely avoid widening or narrowing the lead pins.
- When positioning an LED lamp, basically employ an LED with tie-bar cut or use a spacer.

7-2-2 When an LED 1 is mounted directly on a PWB

If the bottom face of an LED lamp is mounted directly on single-sided PWB, the base of the lead pins may be subjected to physical stress due to PWB warp, cutting or clinching of lead pins. Prior to use, be sure to check that no disconnection inside of the resin or damage to resin etc., is found. When an LED lamp is mounted on a double-sided PWB, the heat during soldering affects the resin; therefore, keep the LED lamp more than 1.6mm afloat above the PWB.

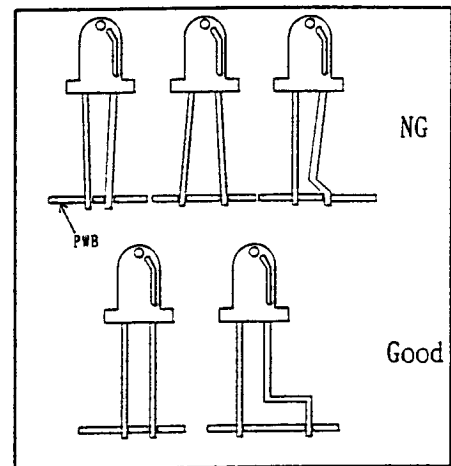

7-2-3 Installation using a holder

During an LED lamp positioning, when a holder is used, a holder should be designed not to subject lead pins to any undue stress.

(Note) Pay attention to the thermal expansion coefficient of the material used for the holder. Since the holder expands and contracts due to preheat and soldering heat, mechanical stress may be applied to the lead pins, resulting in disconnection.

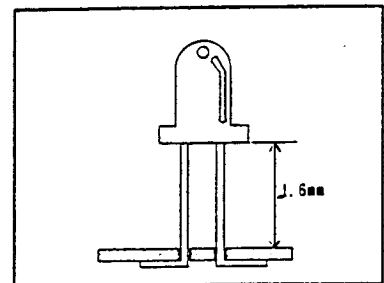

7-2-4 Installation to the case

Do not fix part C with adhesives when fixed to the case as shown in Figure. A hole of the case should be designed not to subject the inside of resin to any undue stress.

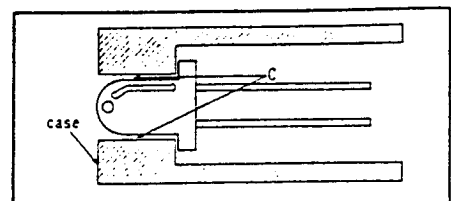
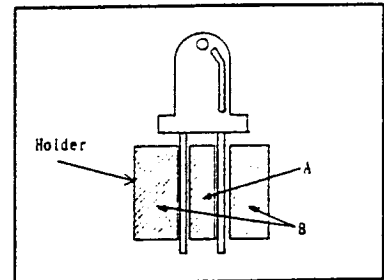

SHARP

7-3. Soldering Conditions

Solder the lead pins under the following conditions

Type of Soldering	Conditions
1. Manual soldering	295°C±5°C, within 3 seconds
2. Wave soldering	260°C±5°C, within 5 seconds
3. Auto soldering	Preheating 70°C to 80°C, within 30 seconds Soldering 245°C±5°C, within 5 seconds

(Note) Avoid dipping resin into soldering bath.

Avoid applying stress to lead pins while they are heated. For example, when the LED lamp is moved with the heat applied to the lead pins during manual soldering or solder repair, disconnection may occur.

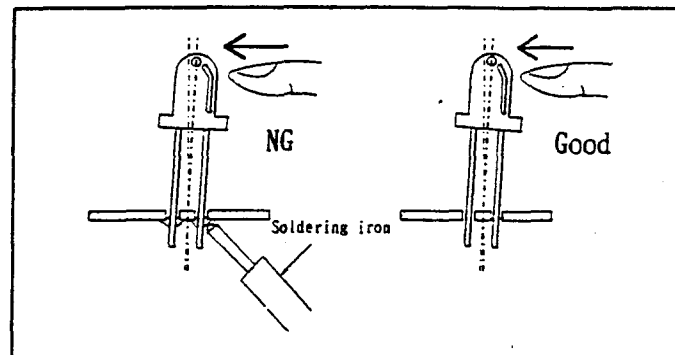

7-4. For cleaning

- (1) Solvent cleaning : Solvent temperature 45°C or less
Immersion for 3 min or less
- (2) Ultrasonic cleaning : The effect to device by ultrasonic cleaning differs by cleaning bath size, ultrasonic power output, cleaning time, PWB size or device mounting condition etc. Please test it in actual using condition and confirm that doesn't occur any defect before starting the ultrasonic cleaning.
- (3) Applicable solvent : Ethyl alcohol, Methyl alcohol, Isopropyl alcohol

In case when the other solvent is used, there are cases that the packaging resin is eroded. Please use the other solvent after thorough confirmation is performed in actual using condition.