

General conditions

BUCK	
V_{GEon}	= 10 V
V_{GEoff}	= 0 V
R_{gon}	= 8 Ω
R_{goff}	= 8 Ω

$V_{out} = 230 \text{ VAC}$

BOOST	
V_{GEon}	= 15 V
V_{GEoff}	= 0 V
R_{gon}	= 8 Ω
R_{goff}	= 8 Ω

Figure 1. Buck MOSFET

Typical average static loss as a function of

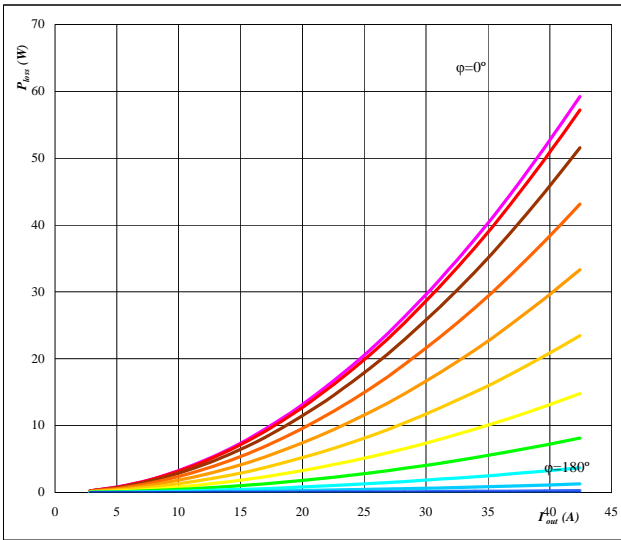

Conditions: $T_j = 125 \text{ }^\circ\text{C}$
parameter: ϕ from 0° to 180°
in 12 steps

Figure 2. Buck FWD

Typical average static loss as a function of output current I_{oRMS}

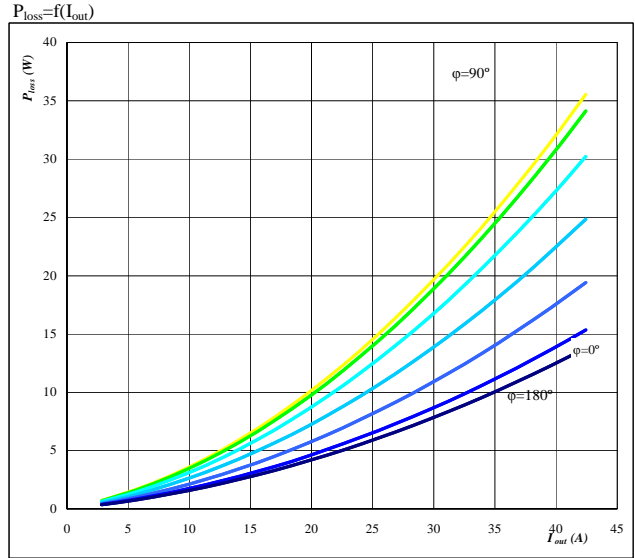

Conditions: $T_j = 125 \text{ }^\circ\text{C}$
parameter: ϕ from 0° to 180°
in 12 steps

Figure 3. Buck MOSFET

Typical average static loss as a function of phase displacement ϕ

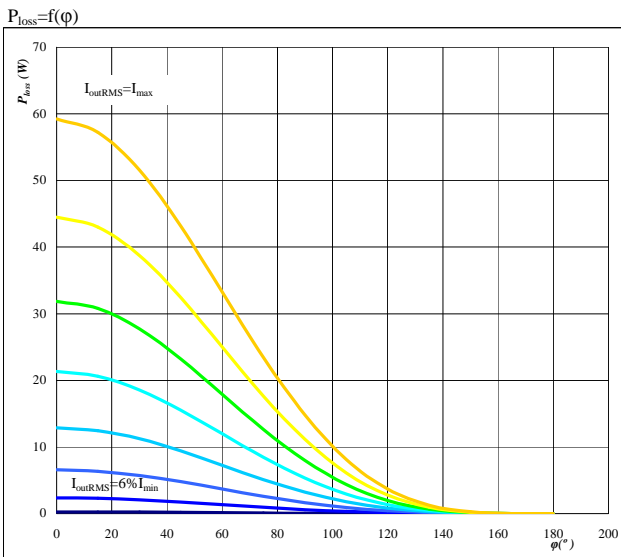

Conditions: $T_j = 125 \text{ }^\circ\text{C}$
parameter: I_{oRMS} from 2,83 A to 42 A
in steps of 6 A

Figure 4. Buck FWD

Typical average static loss as a function of phase displacement ϕ

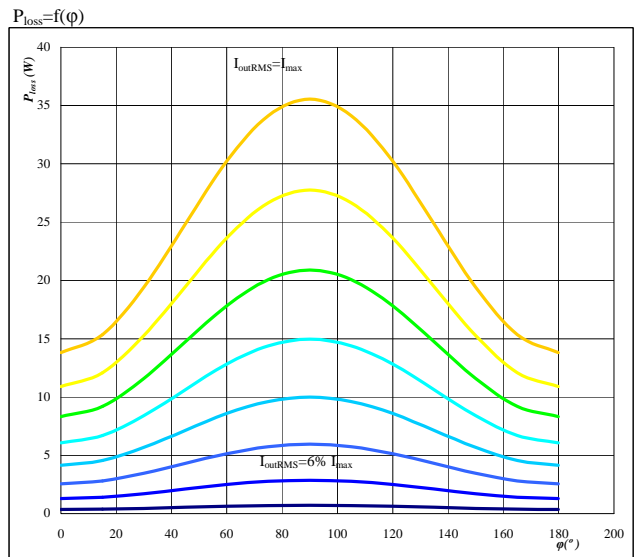

Conditions: $T_j = 125 \text{ }^\circ\text{C}$
parameter: I_{oRMS} from 2,83 A to 42 A
in steps of 6 A

flowNPC 0 NPC Application 600V/30A

Figure 5. Buck MOSFET

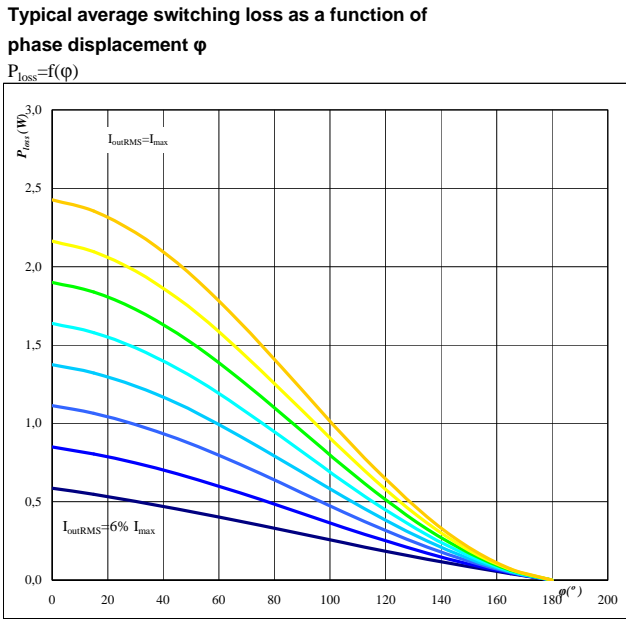

Conditions: $T_j = 125$ °C
 $f_{sw} = 20$ kHz
 DC link = 700 V
 parameter: I_{oRMS} from 2,83 A to 42 A
 in steps of 6 A

Figure 6. Buck FWD

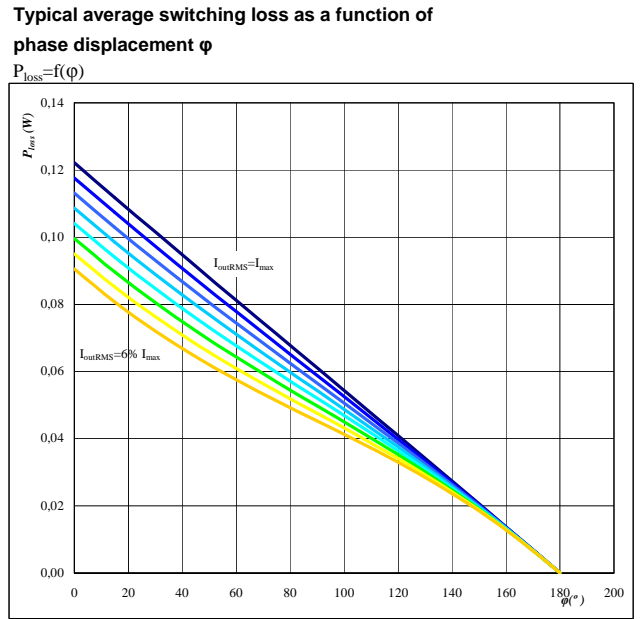

Conditions: $T_j = 125$ °C
 $f_{sw} = 20$ kHz
 DC link = 700 V
 parameter: I_{oRMS} from 2,83 A to 42 A
 in steps of 6 A

Figure 7. Buck MOSFET

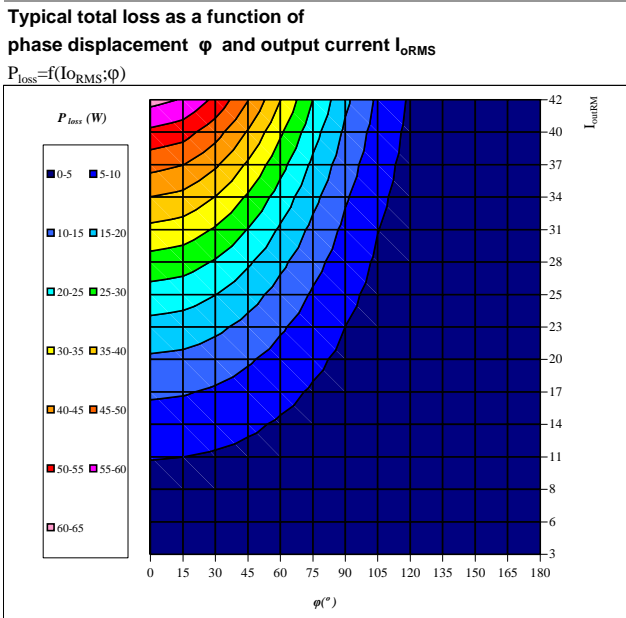

Conditions: $T_j = 125$ °C
 DC link = 700 V
 $f_{sw} = 20$ kHz

Figure 8. Buck FWD

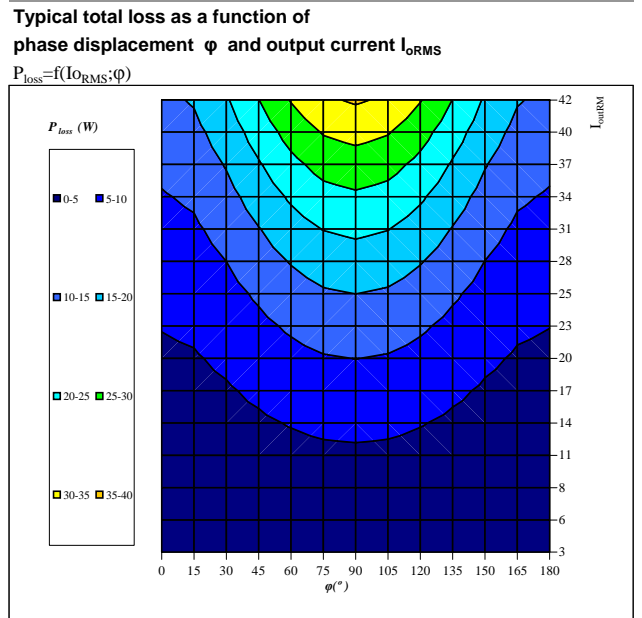

Conditions: $T_j = 125$ °C
 DC link = 700 V
 $f_{sw} = 20$ kHz

flowNPC 0 **NPC Application** 600V/30A

Figure 9. for Buck MOSFET+FWD

Typical available output current as a function of phase displacement ϕ

$I_{out}=f(\phi)$

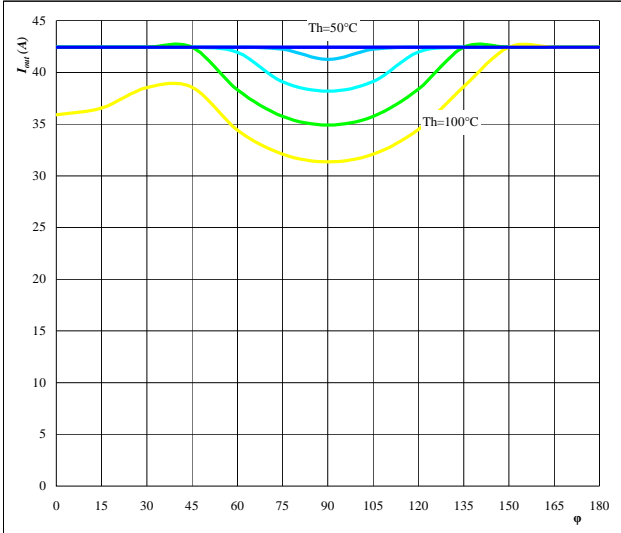

Conditions: $T_j = T_{jmax} - 25 \text{ }^\circ\text{C}$ $f_{sw} = 20 \text{ kHz}$
 DC link = 700 V
 parameter: Heatsink temp.
 T_h from 50 $^\circ\text{C}$ to 100 $^\circ\text{C}$
 in 10 $^\circ\text{C}$ steps

Figure 10. for Buck MOSFET+FWD

Typical available output current as a function of switching frequency f_{sw}

$I_{out}=f(f_{sw})$

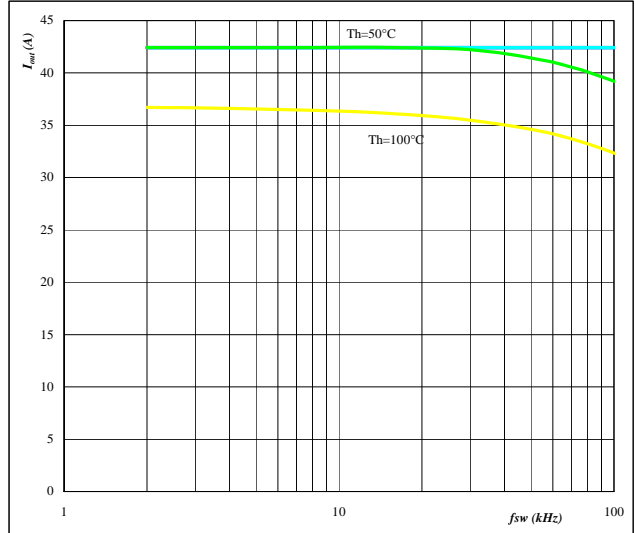

Conditions: $T_j = T_{jmax} - 25 \text{ }^\circ\text{C}$ $\phi = 0^\circ$
 DC link = 700 V
 parameter: Heatsink temp.
 T_h from 50 $^\circ\text{C}$ to 100 $^\circ\text{C}$
 in 10 $^\circ\text{C}$ steps

Figure 11. for Buck IGBT+FWD

Typical available 50Hz output current as a function of f_{sw} and phase displacement ϕ

$I_{out}=f(f_{sw}, \phi)$

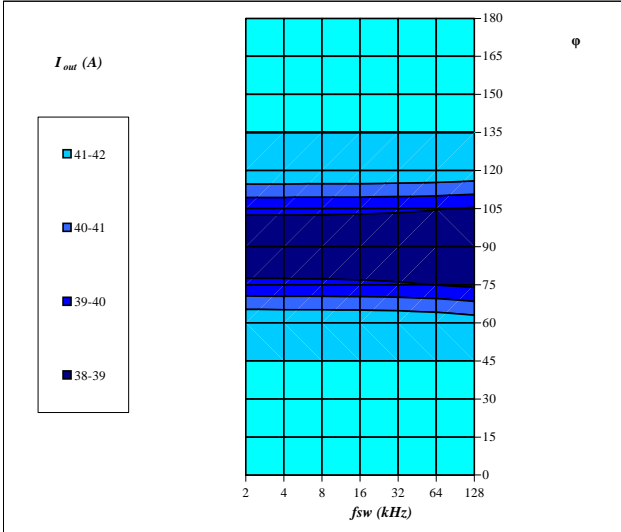

Conditions: $T_j = T_{jmax} - 25 \text{ }^\circ\text{C}$
 DC link = 700 V
 $T_h = 80 \text{ }^\circ\text{C}$

flowNPC 0 NPC Application 600V/30A

Figure 12. Boost IGBT

Typical average static loss as a function of output current

$$P_{loss} = f(I_{out})$$

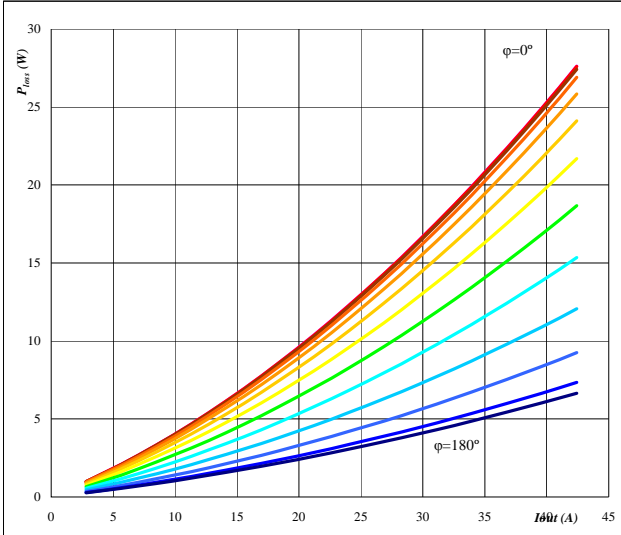

Conditions: $T_j = 125^\circ\text{C}$
parameter: φ from 0° to 180°
in 12 steps

Figure 13. Boost FWD

Typical average static loss as a function of output current

$$P_{loss} = f(I_{out})$$

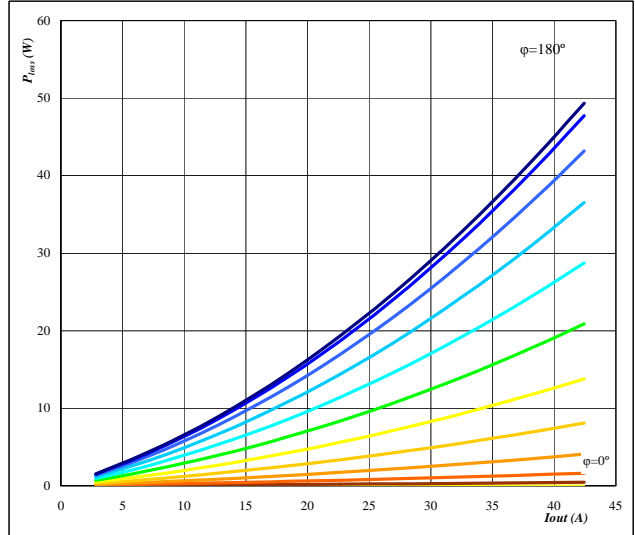

Conditions: $T_j = 125^\circ\text{C}$
parameter: φ from 0° to 180°
in 12 steps

Figure 14. Boost IGBT

Typical average static loss as a function of phase displacement

$$P_{loss} = f(\varphi)$$

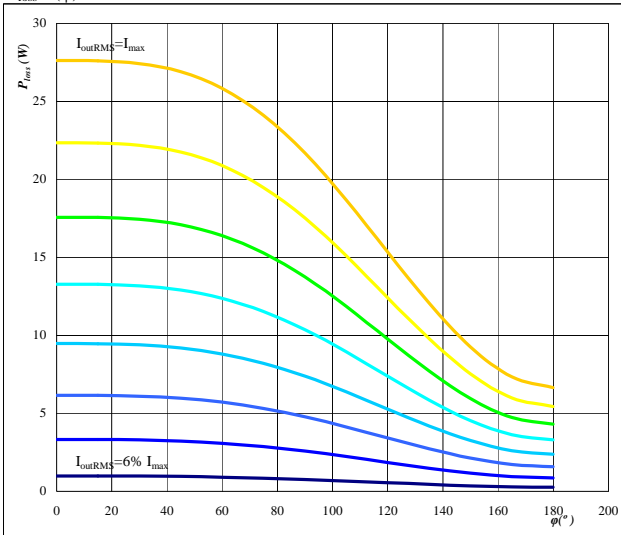

Conditions: $T_j = 125^\circ\text{C}$
parameter: I_{outRMS} from 3 A to 42 A
in steps of 6 A

Figure 15. Boost FWD

Typical average static loss as a function of phase displacement

$$P_{loss} = f(\varphi)$$

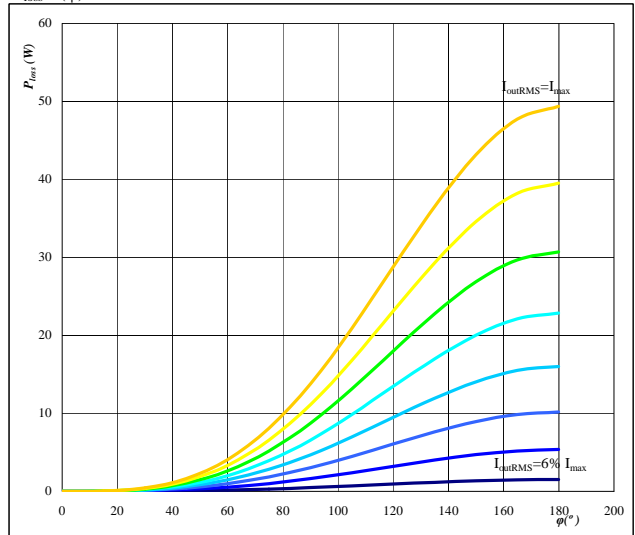

Conditions: $T_j = 125^\circ\text{C}$
parameter: I_{outRMS} from 3 A to 42 A
in steps of 6 A

flowNPC 0 NPC Application 600V/30A

Figure 16. Boost IGBT

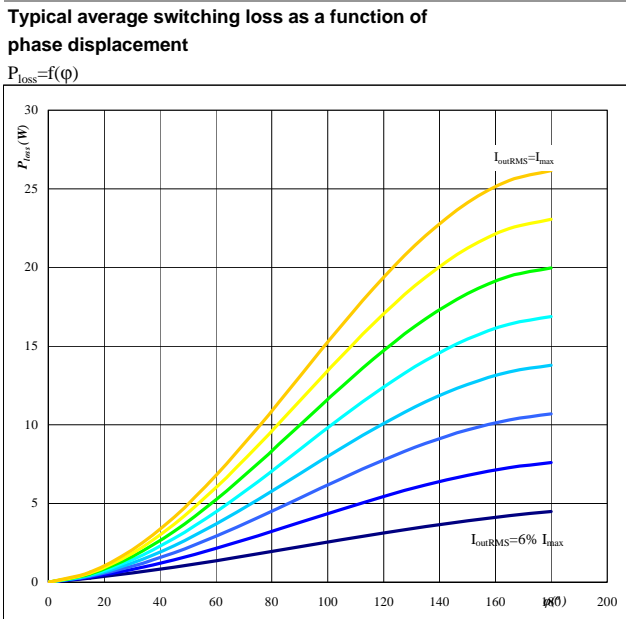

Conditions: $T_j = 125$ °C $f_{sw} = 20$ kHz
 DC link = 700 V
 parameter: I_{oRMS} from 3 A to 42 A
 in steps of 6 A A

Figure 17. Boost FWD

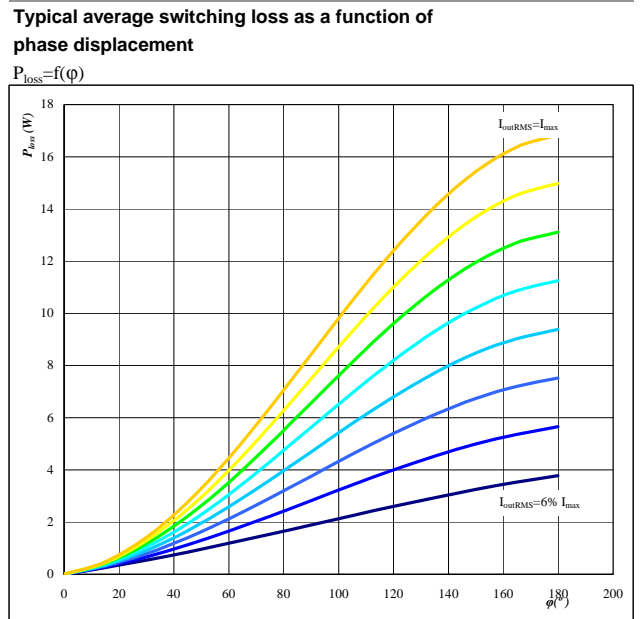

Conditions: $T_j = 125$ °C $f_{sw} = 20$ kHz
 DC link = 700 V
 parameter: I_{oRMS} from 3 A to 42 A
 in steps of 6 A A

Figure 18. Boost IGBT

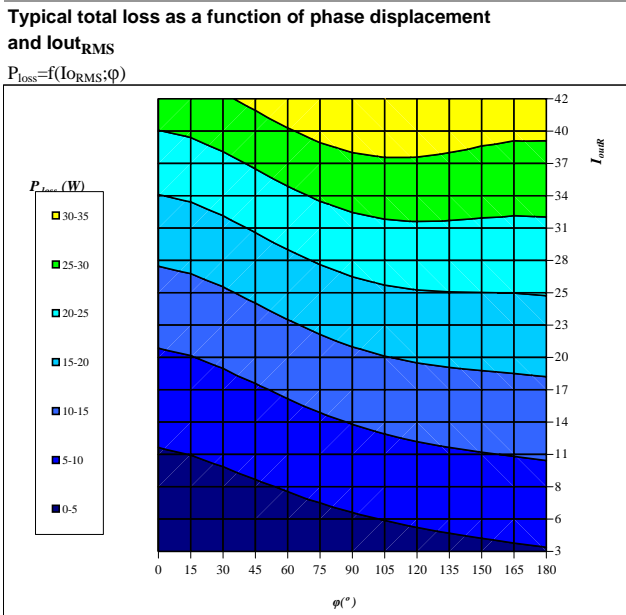

Conditions: $T_j = 125$ °C
 DC link = 700 V
 $f_{sw} = 20$ kHz

Figure 19. Boost FWD

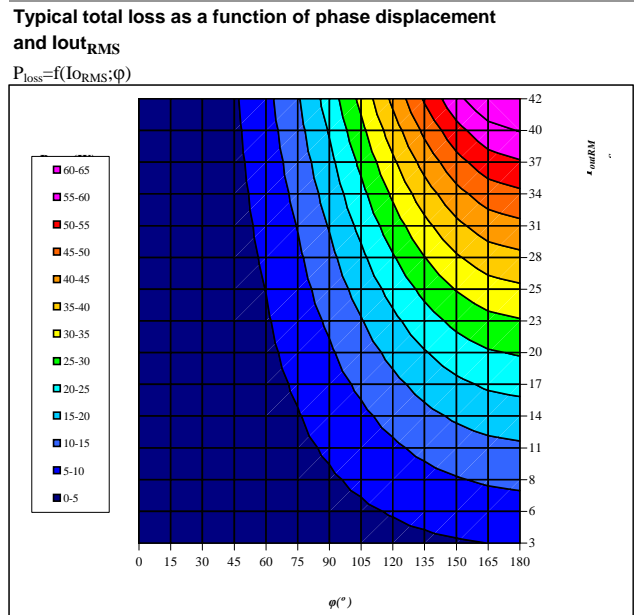

Conditions: $T_j = 125$ °C
 DC link = 700 V
 $f_{sw} = 20$ kHz

flowNPC 0 **NPC Application** 600V/30A

Figure 20. Boost IGBT+FWD

Typical available output current as a function of phase displacement

$I_{out}=f(\phi)$

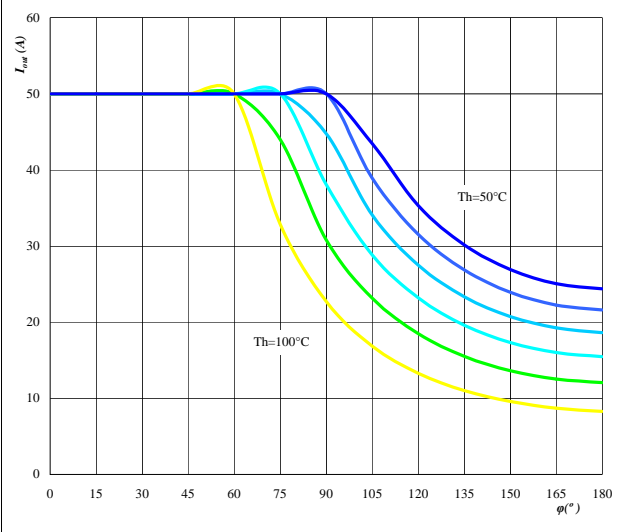

Conditions: $T_j = T_{jmax}-25 \text{ }^\circ\text{C}$ $f_{sw} = 20 \text{ kHz}$
 DC link = 700 V
 parameter: Heatsink temp.
 Th from 50 $^\circ\text{C}$ to 100 $^\circ\text{C}$
 in 10 $^\circ\text{C}$ steps

Figure 21. Boost IGBT+FWD

Typical available output current as a function of switching frequency

$I_{out}=f(f_{sw})$

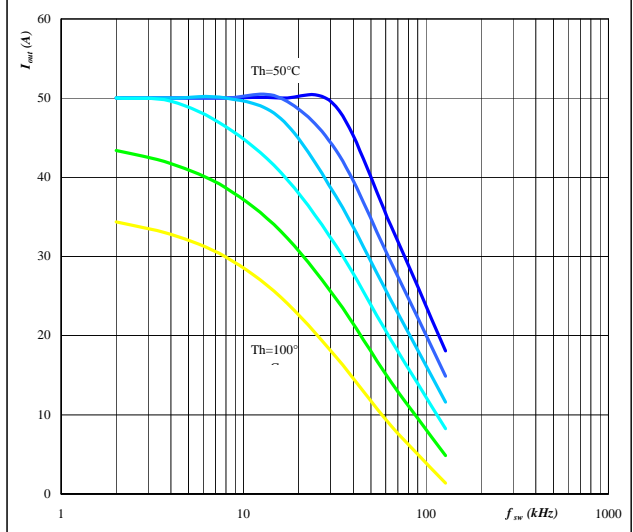

Conditions: $T_j = T_{jmax}-25 \text{ }^\circ\text{C}$ $\phi = 90^\circ$
 DC link = 700 V
 parameter: Heatsink temp.
 Th from 50 $^\circ\text{C}$ to 100 $^\circ\text{C}$
 in 10 $^\circ\text{C}$ steps

Figure 22. Boost IGBT+FWD

Typical available 50Hz output current as a function of fsw and phase displacement

$I_{out}=f(f_{sw},\phi)$

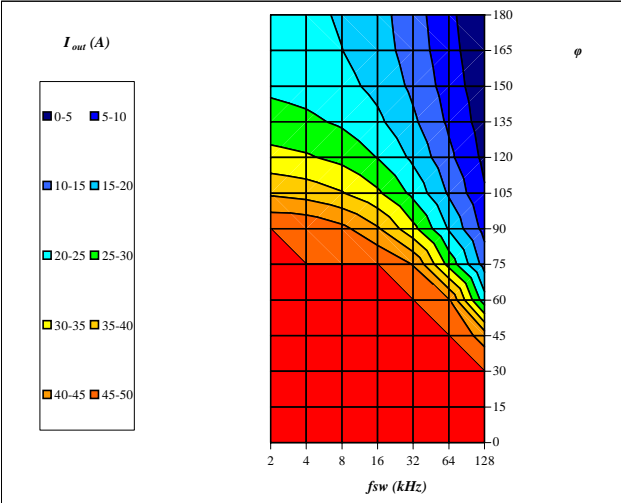

Conditions: $T_j = T_{jmax}-25 \text{ }^\circ\text{C}$
 DC link = 700 V
 $T_h = 80 \text{ }^\circ\text{C}$

flowNPC 0 NPC Application 600V/30A

Figure 23. per MODULE

Typical available output current as a function of heat sink temperature

$I_{out}=f(T_h)$

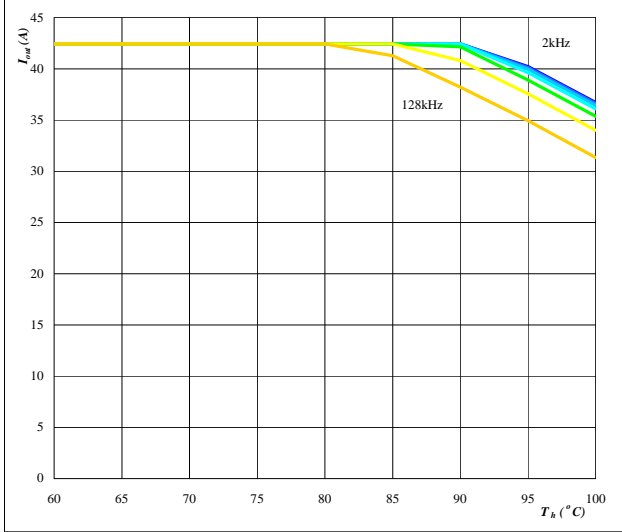

Conditions: $T_j = T_{jmax} - 25 \text{ } ^\circ\text{C}$
 DC link= 700 V
 $\varphi = 0^\circ$
 parameter: Switching freq.
 fsw from 2 kHz to 128 kHz
 in steps of factor 2

Figure 24. per MODULE

Typical available output current as a function of phase displacement

$I_{out}=f(\varphi)$

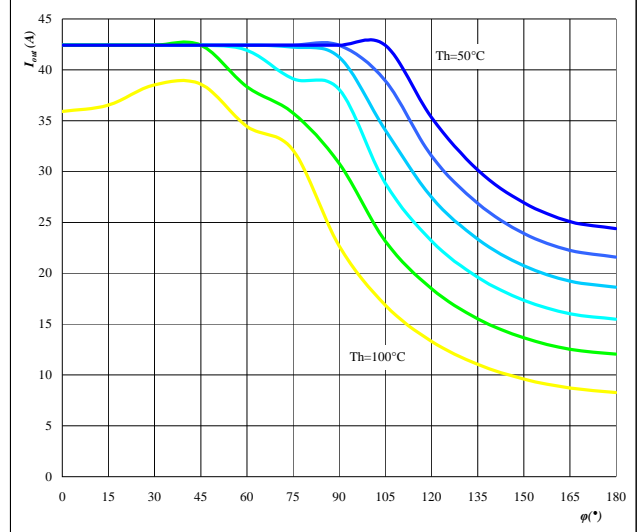

Conditions: $T_j = T_{jmax} - 25 \text{ } ^\circ\text{C}$
 DC link= 700 V
 $f_{sw} = 20 \text{ kHz}$
 parameter: Heatsink temp.
 Th from 50 °C to 100 °C
 in 10 °C steps

Figure 25. per MODULE

Typical available output current as a function of switching frequency

$I_{out}=f(f_{sw})$

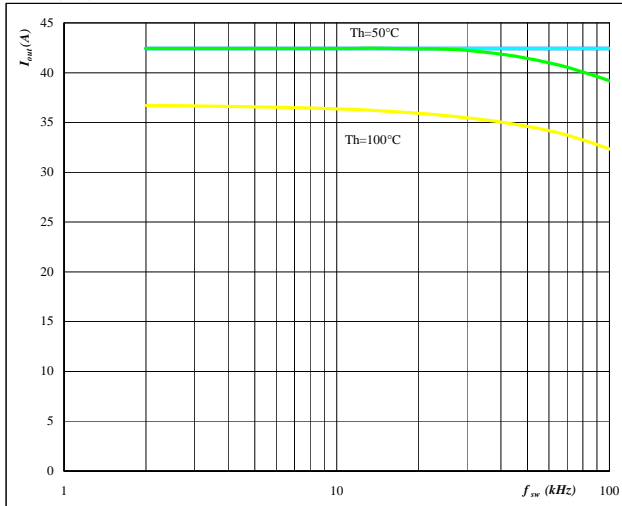

Conditions: $T_j = T_{jmax} - 25 \text{ } ^\circ\text{C}$ $\varphi = 0^\circ$
 DC link= 700 V
 parameter: Heatsink temp.
 Th from 50 °C to 100 °C
 in 10 °C steps

Figure 26. per MODULE

Typical available 50Hz output current as a function of fsw and phase displacement

$I_{out}=f(f_{sw}, \varphi)$

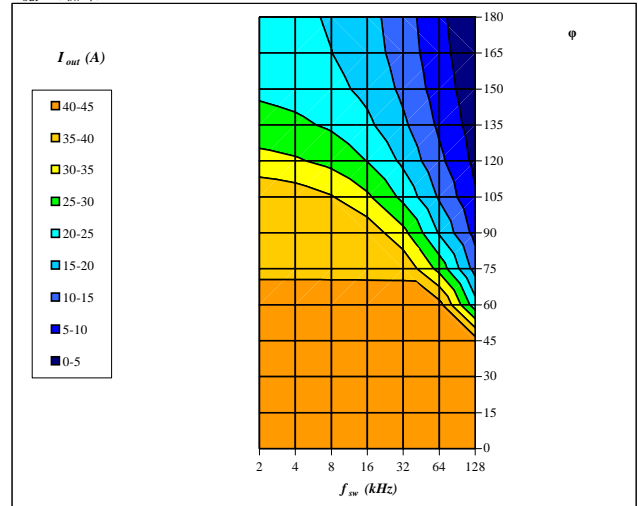

Conditions: $T_j = T_{jmax} - 25 \text{ } ^\circ\text{C}$
 DC link= 700 V
 $T_h = 80 \text{ } ^\circ\text{C}$

Figure 27. per MODULE

Typical efficiency as a function of output power

$$\eta=f(P_{out})$$

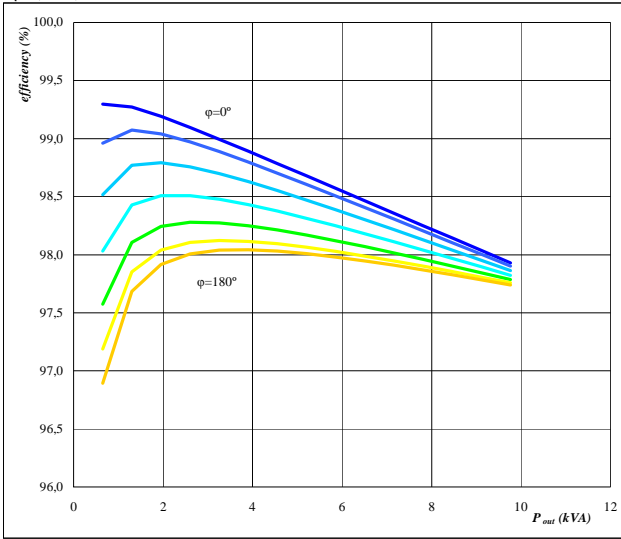

Conditions: $T_j = 125 \text{ }^\circ\text{C}$
 $f_{sw} = 20 \text{ kHz}$
 DC link = 700 V

parameter: phase displacement φ from 0° to 180° in steps of 30°

Figure 28. per MODULE

Typical efficiency as a function of output power

$$\eta=f(P_{out})$$

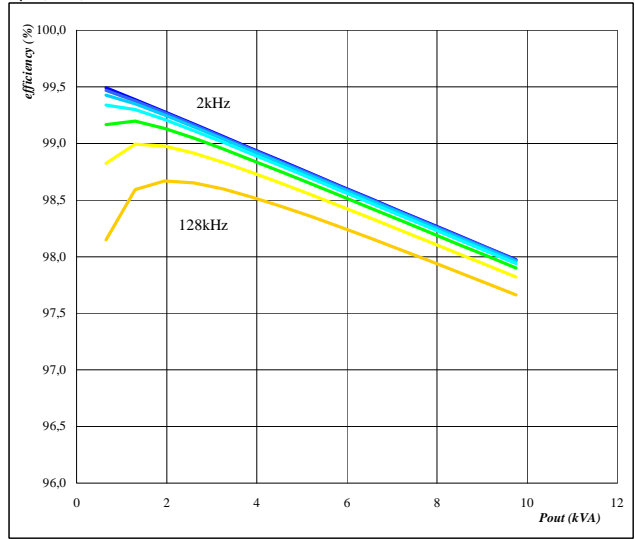

Conditions: $T_j = 125 \text{ }^\circ\text{C}$ $\varphi = 0^\circ$
 DC link = 700 V

parameter: Switching freq. f_{sw} from 2 kHz to 128 kHz in steps of factor 2

Figure 29. per MODULE

Typical available output power as a function of heat sink temperature

$$P_{out}=f(T_h)$$

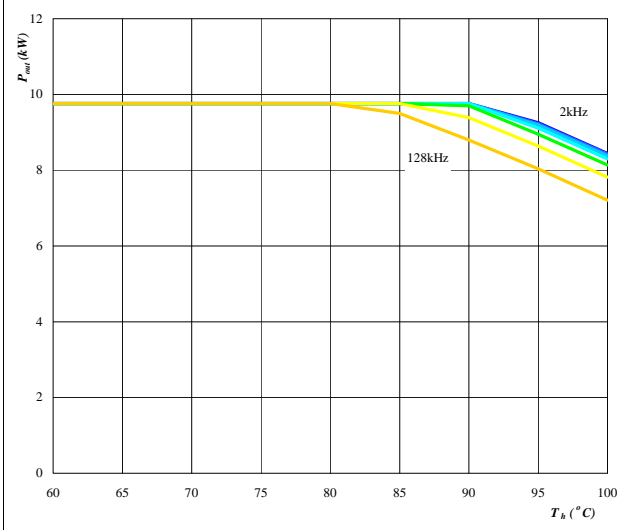

Conditions: $T_j = T_{jmax} - 25 \text{ }^\circ\text{C}$
 DC link = 700 V
 $\varphi = 0^\circ$

parameter: Switching freq. f_{sw} from 2 kHz to 128 kHz in steps of factor 2

flowNPC 0 NPC Application 600V/30A

Figure 30. per MODULE

Typical loss distribution as a function of output current

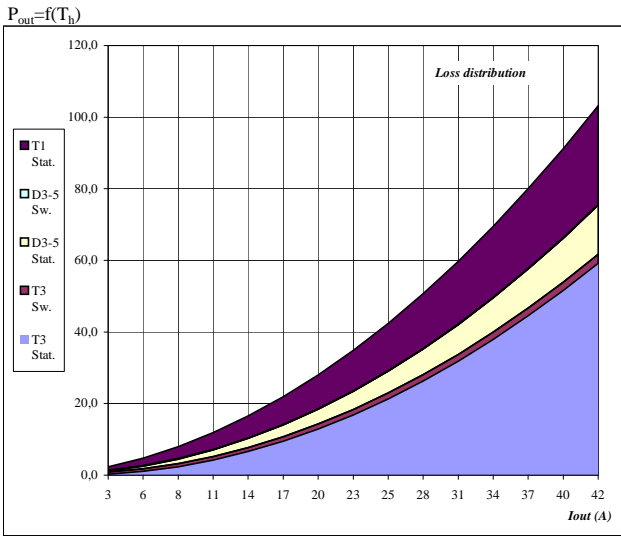

Conditions: $T_j = 125$ °C
 $f_{sw} = 20$ kHz
DC link = 700 V
 $\phi = 0^\circ$

Figure 31. Typical application

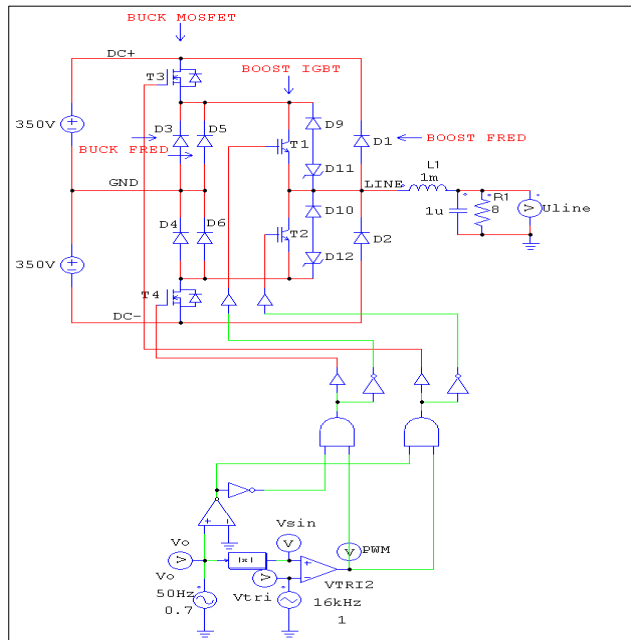
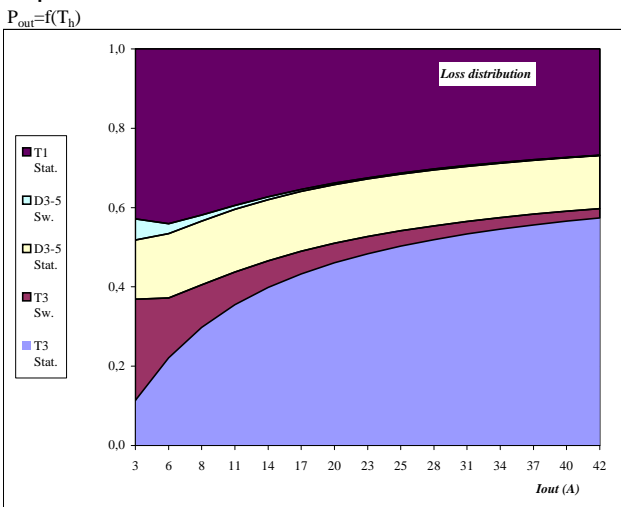

Figure 32. per MODULE

Typical relativ loss distribution as a function of output current



Conditions: $T_j = 125$ °C
 $f_{sw} = 20$ kHz
DC link = 700 V
 $\phi = 0^\circ$