



Website: www.displaytech.com.hk

LCD Module

Product Specification

Product: DT018ATFT
1.8" TFT Display Module (128RGBx160DOTS)

Contents in this document are subject to change without notice. No part of this document may be reproduced or transmitted in any form or by any means, electronic or mechanical, for any purpose, without the express written permission of Displaytech Ltd.

8 March 2011.

1. REVISION RECORD

VERSION	CHANGES	DATE
1.0	Initial revision	8 March 2011

Table of Content

1. REVISION RECORD	1
2. Introduction	3
3. General Specifications	3
4. Mechanical Drawing.....	4
5. Interface Description	5
6. Absolute Maximum Ratings	7
7. Electrical Characteristics.....	7
8. Display Controller /Power Supply Timing	7
9. Backlight specification	8
10. Optical Characteristics.....	8
11. Safety Precaution	11

2. Introduction

DT018ATFT is a display module that contains a TFT display with a 160 * 128 RGB resolution. The driver used for this project is the Ilitek **ILI9163C or compatible** and can display 262K colors. The driver is mounted on the glass and the interconnection via FPC including components to drive the display module.

3. General Specifications

Item	Specification	Unit
LCD mode	Transmissive	---
Resolution	128(RGB)	Line
	160	Line
Diagonal Size	1.8	Inch
Overall Size	34.00	mm
	46.70	mm
Active area	28.03	mm
	35.04	mm
Optimum Viewing Direction	6 o'clock	---
Driver IC	ILI9163C	---
Interface type	MCU parallel / RGB (1)	---
Colours	262K	---
Operation temperature range (DT018ATFT)	-20~70	°C
Storage temperature range (DT018ATFT)	-30~80	°C

Remarks:

- (1) Serial interface is available, but not recommendable, as the speed of it is very slow.
- (2) Recommended mating connector: Hirose FH19SC-45S-0.5SH, FH12S-45S-0.5SH; or Molex 0512964593, 0512964594; or equivalent
- (3) Color tune may be changed slightly by temperature and driving voltage.
- (4) RoHS compliant.

Component Life Cycle

- 1) Storage Life: min. 1 Year
- 2) Operation Life (*1): min. 43 x 10³ h (24hr/day x 7days/week x 52weeks/year x 5years)
(Not include backlight)
- 3) Storage and Operation Life Times are defined for a temperature of +25°C

Notes:

*1. Operation life ends when one of the listed faults occurs:

- The on/off response-times reach 1.5 times of the max. value specified for a new display
- The contrast is reduced to 0.5 of the original contrast value
- Loss of function
- The number of cosmetic defects exceeds the maximum defined

4. Mechanical Drawing

• DT018ATFT

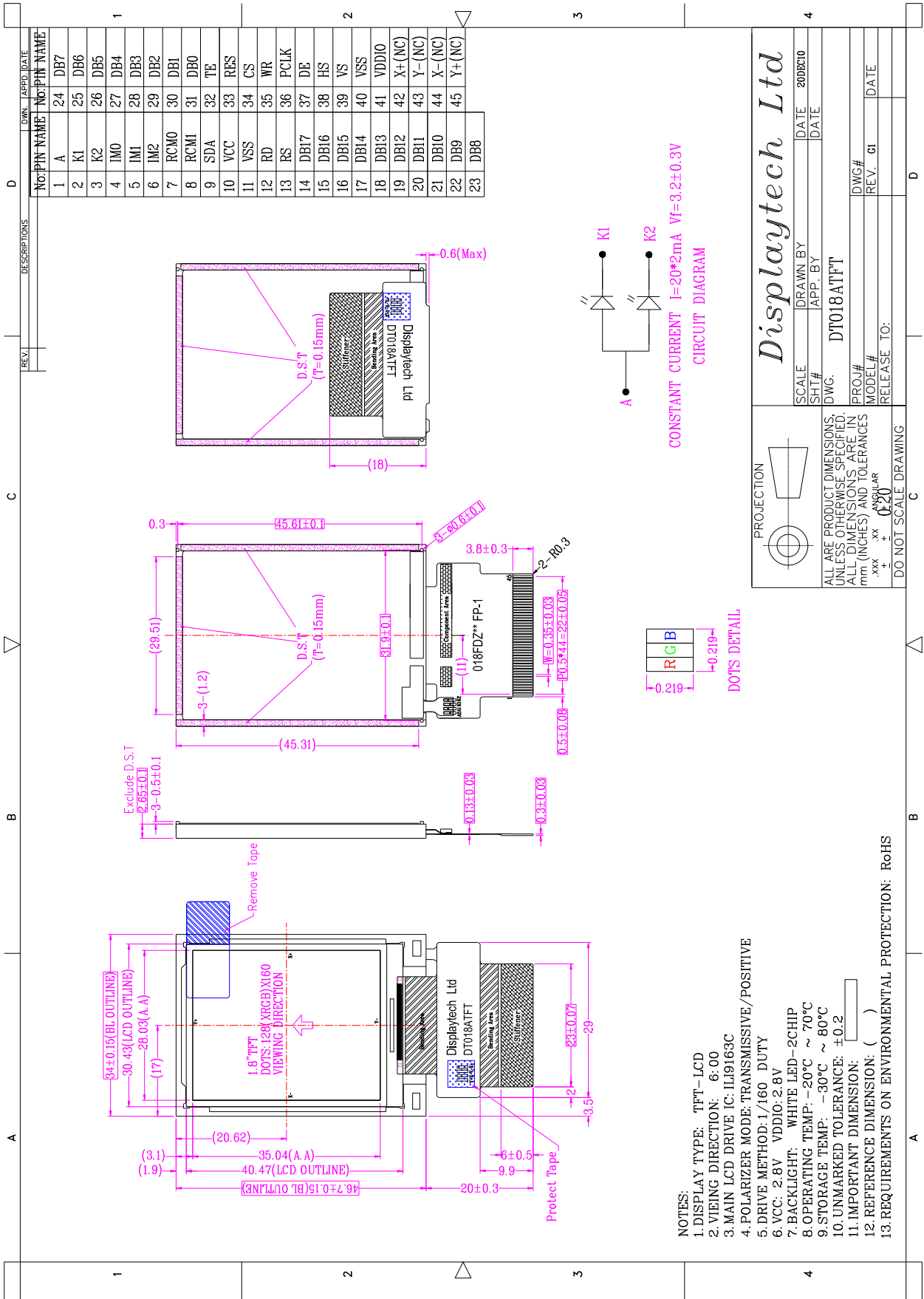

5. Interface Description

Pin no	Symbol	I/O	Description															
1	LEDA	---	Backlight anode.															
2	LED K1	---	Backlight cathode K1															
3	LED K2	---	Backlight cathode K2															
4	IM0	I	MCU parallel interface type selection <table border="1" style="margin-left: auto; margin-right: auto;"> <thead> <tr> <th>IM1</th> <th>IM0</th> <th>Parallel interface</th> </tr> </thead> <tbody> <tr> <td>0</td> <td>0</td> <td>MCU 8-bit Parallel</td> </tr> <tr> <td>0</td> <td>1</td> <td>MCU 16-bit Parallel</td> </tr> <tr> <td>1</td> <td>0</td> <td>MCU 9-bit Parallel</td> </tr> <tr> <td>1</td> <td>1</td> <td>MCU 18-bit Parallel</td> </tr> </tbody> </table>	IM1	IM0	Parallel interface	0	0	MCU 8-bit Parallel	0	1	MCU 16-bit Parallel	1	0	MCU 9-bit Parallel	1	1	MCU 18-bit Parallel
IM1	IM0			Parallel interface														
0	0	MCU 8-bit Parallel																
0	1	MCU 16-bit Parallel																
1	0	MCU 9-bit Parallel																
1	1	MCU 18-bit Parallel																
5	IM1																	
6	IM2	I	MCU Parallel interface bus and Serial interface select - IM2 = '1'; Parallel Interface - IM2 = '0'; Serial Interface															
7	RCM0	I	RGB and MCU interface mode selection pin <table border="1" style="margin-left: auto; margin-right: auto;"> <thead> <tr> <th>RCM1</th> <th>RCM0</th> <th>Resolution selection</th> </tr> </thead> <tbody> <tr> <td>0</td> <td>X</td> <td>MCU interface mode</td> </tr> <tr> <td>1</td> <td>0</td> <td>RGB interface(1)</td> </tr> <tr> <td>1</td> <td>1</td> <td>RGB interface(2)</td> </tr> </tbody> </table>	RCM1	RCM0	Resolution selection	0	X	MCU interface mode	1	0	RGB interface(1)	1	1	RGB interface(2)			
RCM1	RCM0	Resolution selection																
0	X	MCU interface mode																
1	0	RGB interface(1)																
1	1	RGB interface(2)																
8	RCM1	I																
9	SDA	I	When RCM1, RCM0='1X'(RGB I/F), serial input/output signal in serial I/F mode. The data is input on the rising edge of the SCL signal. The data is output on the falling edge of the SCL signal. When RCM1, RCM0='0X'(MCU I/F), this pin is not used, and fix at VDDI or GND level. If not used, please fix this pin at VDDI or GND level.															
10	VCC	---	Power supply 2.8V															
11	GND / VSS	---	Power ground 0V															
12	RD	I	Read enable in 8080-parallel interface and Read/ Write operation enable pin in 6800-parallel interface. In 8080-parallel interface, if not used, please connect this pin to VDDI. In 6800-parallel interface, if not used, please connect this pin to VDDI or GND.															
13	RS	I	Display data / Command selection pin in parallel and SCL in 3-pin SPI interface. RS='1': Display data. RS='0': Command data. If not used, please connect this pin to GND.															
14~31	DB17~DB0	I/O	When RCM='0' (MCU I/F), D[17:0] are used to MCU parallel interface data bus, and D0 is also the serial input/ output signal in SPI interface mode. In serial interface, D[17:1] are not used and should be connected to ground.															
32	TE	O	Tearing effect output pin to synchronies MCU to frame writing, activated by S/W command. When this pin is not activated, this pin is low. If not used, please open this pin.															
33	RES	I	Chip reset pin ("Low Active"). This signal low will reset the device and must be applied to properly initialize the chip.															
34	CS	I	Chip select input pin ("Low" enable). This pin can be permanently fixed "Low" in MCU interface mode only.															
35	WR	I	Write enable in parallel interface. WR: for 8080 MCU R/WX: for 6800 MCU RS: for 4-wire SPI If not used, please connect this pin to VDDI or GND.															

Pin no	Symbol	I/O	Description
36	PCLK	I	Pixel clock signal in RGB I/F mode. -If it's not used, please fix this pin at GND level.
37	DE	I	Data enable signal in RGB I/F mode. -If it's not used, please fix this pin at GND level.
38	HS	I	Horizontal sync. signal in RGB I/F mode. -If it's not used, please fix this pin at GND level.
39	VS	I	Vertical sync. signal in RGB I/F mode. -If it's not used, please fix this pin at GND level.
40	GND / VSS	---	Power ground 0V
41	VDDIO	---	Logic power supply 2.8V
42	NC (X+)	---	No connection (X+ of touch screen)
43	NC (Y-)	---	No connection (Y- of touch screen)
44	NC (X-)	---	No connection (X- of touch screen)
45	NC (Y+)	---	No connection (Y+ of touch screen)

6. Absolute Maximum Ratings

(Ta=25°C)

Item	Symbol	Min.	Max.	Unit
Power supply voltage	VCC	-0.3	+ 4.6	V
Logic signal input/output voltage	Vcc	-0.3	+ 4.6	V
Operating Temperature	TOP	-20	+70	°C
Storage Temperature	TST	-30	+80	°C

Note:

- When temperature is below 0°C, the response time of liquid crystal (LC) will be slower and the color of panel will be darker.
- If module driving condition exceeds the absolute maximum ratings, permanent damaged may be resulted. If module is driven within the absolute maximum ratings but exceeded the DC characteristics, mal-function may be resulted.
- VDD/VCC > VSS

7. Electrical Characteristics

DC Characteristics

(Vss=0V, Ta=25°C)

Item	Symbol	Condition	Min.	Typ.	Max.	Unit
Power supply	VCC / VDD		2.5	2.8	3.3	V
Input voltage "H"	VIH	---	0.7 VCC	---	VCC	V
Input voltage "L"	VIL	---	VSS	---	0.3 VCC	V
Output voltage "H"	VOH	IOL=-1.0mA	0.8 VCC	---	VCC	V
Output voltage "L"	VOL	IOL=1.0mA	VSS	---	0.2 VCC	V

8. Display Controller /Power Supply Timing

See Display Controller Specification: Ilitek ILI9163C

9. Backlight specification

(Vcc=3.0V, Vss=0V, Ta=25°C)

Item	Symbol	Condition	Min	Typ	Max	Unit	Note
Supply voltage	Vf	If=20mA x2	2.9	---	3.5	V	1
Forward current	If		---	40	---	mA	2
Uniformity	ΔBp	If=30mA	80	---	---	%	
Color coordination	X		0.260	---	0.305	---	
	Y		0.265	---	0.305	---	

LED circuit diagram:

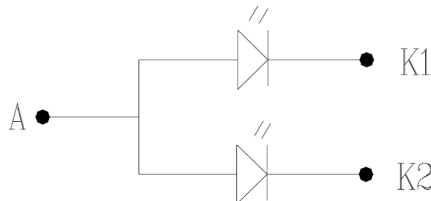

Constant current If=20x2mA; Vf=3.2±0.3V(typ)

Note:

- 1) The LED's driver mode needs to be constant current mode.
- 2) Permanent damage to the device may occur if maximum values are exceeded. Functional operation should be restricted to the conditions described under normal operating conditions.

10. Optical Characteristics

(Vcc=2.8V, Vss=0V, Ta=25°C)

Item	Symbol	Condition	Min	Typ	Max	Unit	Note
Brightness	Bp	θ=0°	250	280	---	cd/m ²	1
Uniformity	ΔBp	Φ=0°	80	---	---	%	1, 2
Viewing Angle	θ1 (Φ=90° or 270°)	Cr≥10	-65 ~ 65			deg	3
	θ2 (Φ=0° or 180°)		-50 ~ 40				
Contrast ratio	Cr	θ=0°	---	350	---	---	4
Response Time	Tr	Φ=0°	---	30	---	ms	5
	Tf						
CIE (x,y) Chromaticity	White	x	0.2451	0.2951	0.3451	---	1, 6
		y	0.2664	0.3164	0.3664		
	Red	x	0.5333	0.5833	0.6333		
		y	0.2804	0.3304	0.3804		
	Green	x	0.2913	0.3413	0.3913		
		y	0.5314	0.5814	0.6314		
	Blue	x	0.1036	0.1536	0.2036		
		y	0.0465	0.0965	0.1465		
NTSC Ratio	S		---	51	---	%	

L/6
L/3
L/3

Note 1: The data are measured after LEDs are turned on for 5 minutes. LCM displays full white.
 The brightness is the average value of 9 measured spots. Measurement equipment PR-705 (Φ8mm)

Measuring condition:

- Measuring surroundings: Dark room.
- Measuring temperature: Ta=25°C.
- Adjust operating voltage to get optimum contrast at the center of the display.

Measured value at the center point of LCD panel after more than 5 minutes while backlight turning on.

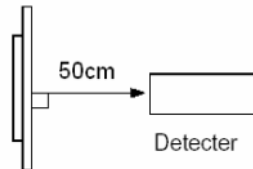

Note 2: The luminance uniformity is calculated by using following formula.

$$\Delta Bp = Bp (\text{Min.}) / Bp (\text{Max.}) \times 100 (\%)$$

Bp (Max.) = Maximum brightness in 9 measured spots

Bp (Min.) = Minimum brightness in 9 measured spots.

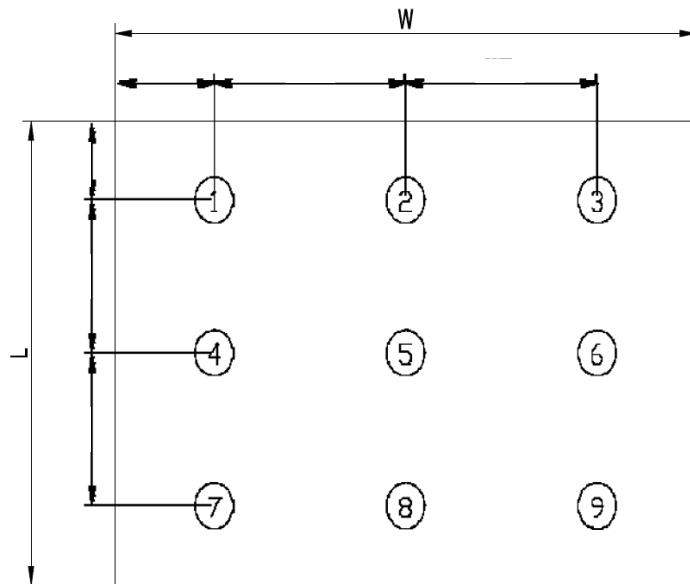

Measurement equipment PR-705 (Φ8mm)

Note 3: The definition of viewing angle:
 Refer to the graph below marked by θ and Φ

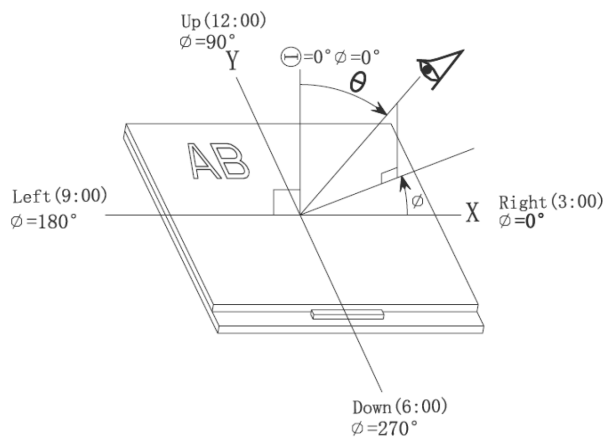

Note 4: The definition of contrast ratio (Test LCM using PR-705):

$$\text{Contrast Ratio (CR)} = \frac{\text{Luminance When LCD is at "White" state}}{\text{Luminance When LCD is at "Black" state}}$$

(Contrast Ratio is measured in optimum common electrode voltage)

Note 5: Definition of Response time. (Test LCD using DMS501):

The output signals of photo detector are measured when the input signals are changed from "black" to "white" (falling time) and from "white" to "black" (rising time), respectively.

The response time is defined as the time interval between the 10% and 90% of amplitudes. Refer to figure as below.

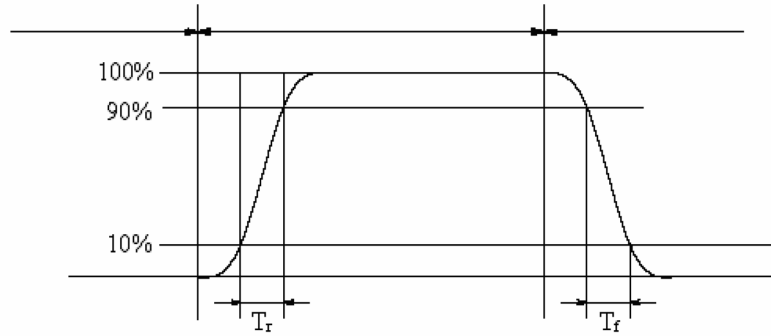

The definition of response time

Note 6: Definition of Color of CIE Coordinate and NTSC Ratio.

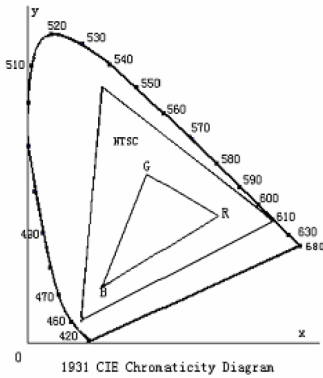

Color gamut:

$$S = \frac{\text{area of RGB triangle}}{\text{area of NTSC triangle}} \times 100\%$$

11. Safety Precaution

Handling precautions:

- This device is susceptible to Electro-Static Discharge (ESD) damage. Observe Anti-Static precautions.

Power supply precautions:

- Identify and, at all times, observe absolute maximum ratings for both logic and LC drivers. Note that there is some variance between models.
- Prevent the application of reverse polarity to VCC and GND, however briefly.
- Use a clean power source free from transients. Power up conditions are occasionally “jolting” and may exceed the maximum ratings of the modules.
- The VCC power of the module should also supply the power to all devices that may access the display. Don’t allow the data bus to be driven when the logic supply to the module is turned off.

Operating precautions:

- DO NOT plug or unplug the module when the system is powered up.
- Minimize the cable length between the module and host MPU.
- Operate the module within the limits of the modules temperature specifications.

Mechanical/Environmental precautions:

- Improper soldering is the major cause of module difficulty. Use of flux cleaner is not recommended as they may seep under the elastomeric connection and cause display failure.
- Mount the module so that it is free from torque and mechanical stress.
- Surface of the LCD panel should not be touched or scratched. The display front surface is an easily scratched, plastic polarizer. Avoid contact and clean only when necessary with soft, absorbent cotton dampened with petroleum benzene.
- Always employ anti-static procedure while handling the module.
- Prevent moisture build-up upon the module and observe the environmental constraints for storage temperature and humidity.
- Do not store in direct sunlight
- If leakage of the liquid crystal material should occur, avoid contact with this material, particularly ingestion. If the body or clothing becomes contaminated by the liquid crystal material, wash thoroughly with water and soap

Mouser Electronics

Authorized Distributor

Click to View Pricing, Inventory, Delivery & Lifecycle Information:

[Displaytech:](#)

[DT018ATFT](#)