



# UC12-12235

UC12

ULTRASONIC SENSORS

**SICK**  
Sensor Intelligence.



### Ordering information

Type	Part no.
UC12-12235	6029834

Other models and accessories → [www.sick.com/UC12](http://www.sick.com/UC12)



### Detailed technical data

#### Performance

<b>Working range, limiting range</b>	55 mm ... 250 mm, 350 mm
<b>Resolution</b>	≥ 0.1 mm
<b>Repeatability</b>	± 0.15 % <sup>1)</sup>
<b>Accuracy</b>	± 1 % <sup>1)</sup>
<b>Temperature compensation</b>	✓
<b>Response time</b>	30 ms
<b>Switching frequency</b>	25 Hz
<b>Output time</b>	8 ms
<b>Ultrasonic frequency (typical)</b>	500 kHz
<b>Detection area (typical)</b>	See diagrams
<b>Additional function</b>	Set switching mode: Distance to object (DtO) / Window (Wnd) / Object between sensor and background (ObSB), teach-in of switching output, temperature compensation, lock user interface, reset to factory default

<sup>1)</sup> Referring to current measurement value.

#### Interfaces

<b>Switching output</b>	2 x NPN (500 mA) <sup>1) 2) 3)</sup>
<b>Hysteresis</b>	2 mm

<sup>1)</sup> Output Q short-circuit protected.

<sup>2)</sup> Complementary switching outputs (Q,  $\bar{Q}$ )

<sup>3)</sup> NPN: HIGH ≤ 2 V / LOW = V<sub>S</sub>.

#### Mechanics/electronics

<b>Supply voltage V<sub>s</sub></b>	DC 10 V ... 30 V <sup>1)</sup>
<b>Power consumption</b>	≤ 1.2 W <sup>2)</sup>
<b>Initialization time</b>	< 300 ms

<sup>1)</sup> Limit values, reverse-polarity protected, operation in short-circuit protected network: max. 8 A.

<sup>2)</sup> Without load.

<b>Design</b>	Rectangular
<b>Housing material</b>	Die-cast zinc Ultrasonic transducer: polyurethane foam, glass epoxy resin
<b>Connection type</b>	Male connector, M12, 4-pin
<b>Indication</b>	Dual LED
<b>Weight</b>	75 g
<b>Sending axis</b>	Straight

1) Limit values, reverse-polarity protected, operation in short-circuit protected network: max. 8 A.

2) Without load.

### Ambient data

<b>Enclosure rating</b>	IP 67
<b>Protection class</b>	III
<b>Ambient temperature</b>	Operation: -25 °C ... +70 °C Storage: -40 °C ... +85 °C

### Dimensional drawing (Dimensions in mm (inch))

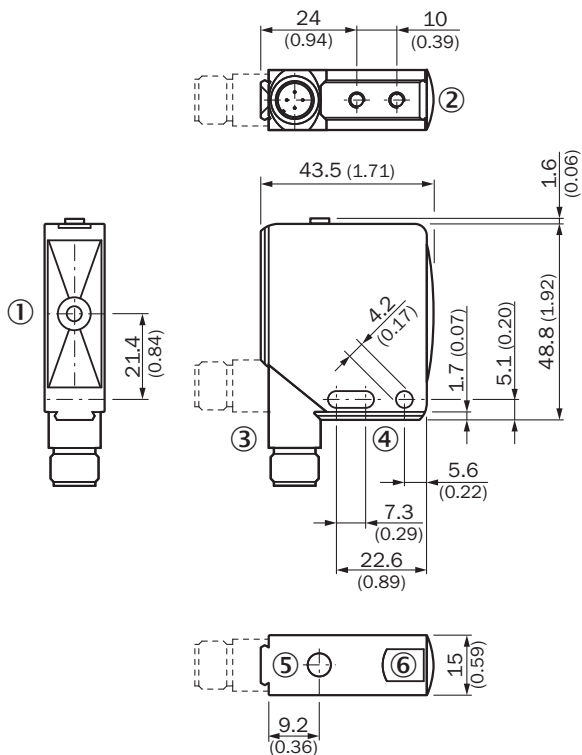

- ① Sender and receiver axis
- ② M4 threaded mounting hole, 4 mm deep
- ③ Connection
- ④ Fixing hole
- ⑤ Operating elements
- ⑥ Status indicator switching output (orange) and power on (green)

### Connection type

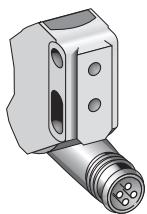

### Connection diagram

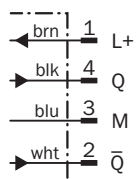

### Adjustment possible

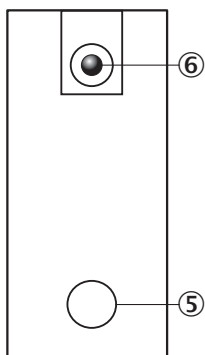

⑤ Operating elements

⑥ Status indicator switching output (orange) and power on (green)

## Detection area



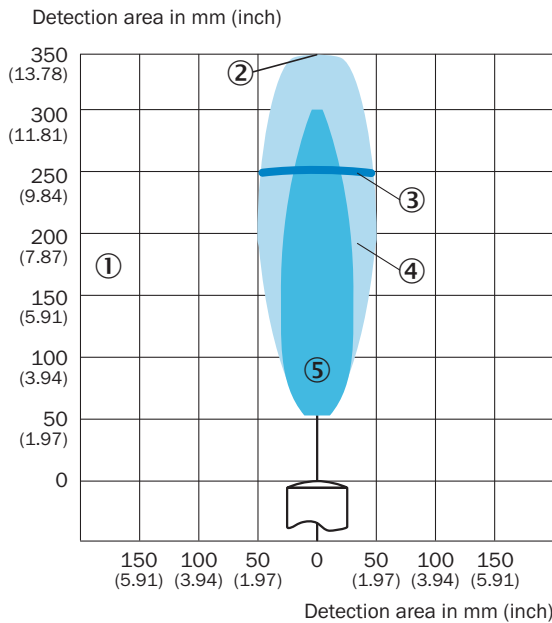

UC12-12



- ① Sensing range dependent on reflection properties, size and orientation of the object
- ② Limiting range
- ③ Working range
- ④ Example object: aligned plate 10 mm x 10 mm
- ⑤ Example object: pipe with 10 mm diameter

## Recommended accessories

Other models and accessories → [www.sick.com/UC12](http://www.sick.com/UC12)

	Brief description	Type	Part no.
<b>Universal bar clamp systems</b>			
	Plate D for universal clamp bracket, steel, zinc coated, universal clamp and mounting hardware included	BEF-KHS-D01	2022461
	Plate L for universal clamp bracket, steel, zinc coated, universal clamp and mounting hardware included	BEF-KHS-L01	2023057
	Plate N02 for universal clamp bracket, Zinc plated steel (sheet), Zinc die cast (clamping bracket), Universal clamp (5322626), mounting hardware	BEF-KHS-N02	2051608
<b>Mounting brackets and mounting plates</b>			
	Mounting bracket, large, Stainless steel, mounting hardware included	BEF-WG-W12	2013942
	Mounting bracket, small, Stainless steel, mounting hardware included	BEF-WK-W12	2012938

	Brief description	Type	Part no.
Plug connectors and cables			
	Head A: female connector, M12, 4-pin, straight Head B: cable Cable: PVC, unshielded, 2 m	DOL-1204-G02M	6009382
	Head A: female connector, M12, 4-pin, angled Head B: cable Cable: PVC, unshielded, 2 m	DOL-1204-W02M	6009383

## SICK AT A GLANCE

SICK is one of the leading manufacturers of intelligent sensors and sensor solutions for industrial applications. A unique range of products and services creates the perfect basis for controlling processes securely and efficiently, protecting individuals from accidents and preventing damage to the environment.

We have extensive experience in a wide range of industries and understand their processes and requirements. With intelligent sensors, we can deliver exactly what our customers need. In application centers in Europe, Asia and North America, system solutions are tested and optimized in accordance with customer specifications. All this makes us a reliable supplier and development partner.

Comprehensive services complete our offering: SICK LifeTime Services provide support throughout the machine life cycle and ensure safety and productivity.

For us, that is “Sensor Intelligence.”

## WORLDWIDE PRESENCE:

Contacts and other locations –[www.sick.com](http://www.sick.com)