

## 150KHz, 3A PWM Buck DC/DC Converter

### ■ Features

- Output voltage: 3.3V, 5V, 12V and adjustable output version
- Adjustable version output voltage range, 1.23V to 18V+4%
- 150KHz  $\pm 15\%$  fixed switching frequency
- Voltage mode non-synchronous PWM control
- Thermal-shutdown and current-limit protection
- ON/OFF shutdown control input
- Operating voltage can be up to 22V
- Output load current: 3A
- TO252-5L packages
- Low power standby mode
- Built-in switching transistor on chip

### ■ Applications

- Simple High-efficiency step-down regulator
- On-card switching regulators
- Positive to negative converter

### ■ Pin Assignments

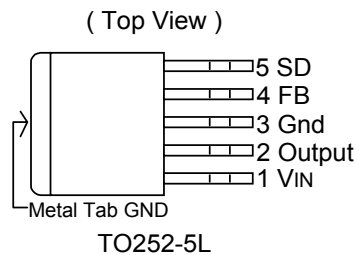

### ■ General Description

The AP1507 series are monolithic IC designed for a step-down DC/DC converter, and own the ability of driving a 3A load without external transistor. Due to reducing the number of external component, the board space can be saved easily. The external shutdown function can be controlled by logic level and then come into standby mode. The internal compensation makes feedback control have good line and load regulation without external design. Regarding protected function, thermal shutdown is to prevent over temperature operating from damage, and current limit is against over current operating of the output switch. If current limit function occurred and  $V_{FB}$  is down to 0.5V below, the switching frequency will be reduced. The AP1507 series operates at a switching frequency of 150KHz thus allowing smaller sized filter components than what would be needed with lower frequency switching regulators. Other features include a guaranteed  $\pm 4\%$  tolerance on output voltage under specified input voltage and output load conditions, and  $\pm 15\%$  on the oscillator frequency. The output version included fixed 3.3V, 5V, 12V, and an adjustable type. The package is available in a 5-lead TO-252.

### ■ Pin Descriptions

Name	Description
$V_{IN}$	Operating voltage input
Output	Switching output
GND	Ground
FB	Output voltage feedback control
SD	ON/OFF Shutdown



## 150KHz, 3A PWM Buck DC/DC Converter

### ■ Absolute Maximum Ratings

Symbol	Parameter	Rating	Unit
$V_{CC}$	Supply Voltage	+24	V
$V_{SD}$	ON/OFF Pin input voltage	-0.3 to +18	V
$V_{FB}$	Feedback Pin voltage	-0.3 to +18	V
$V_{OUT}$	Output voltage to Ground	-1	V
$P_D$	Power dissipation	Internally limited	W
$T_{ST}$	Storage temperature	-65 to +150	°C
$T_{OP}$	Operating temperature	-40 to +125	°C
$V_{OP}$	Operating voltage	+4.5 to +22	V

### ■ Electrical Characteristics (All Output Voltage Versions)

Unless otherwise specified,  $V_{IN}=12V$  for 3.3V, 5V, adjustable version and  $V_{IN}=18V$  for the 12V version.  $I_{LOAD} = 0.5A$

Symbol	Parameter		Conditions	Min.	Typ.	Max.	Unit
$I_B$	Feedback bias current		$V_{FB}=1.3V$ (Adjustable version only)		-10	-50 -100	nA
$F_{OSC}$	Oscillator frequency			127 <b>110</b>	150	173 <b>173</b>	KHz
$F_{SCP}$	Oscillator frequency of short circuit protect		When current limit occurred and $V_{FB} < 0.5V$ , $T_a=25^\circ C$	5	15	25	KHz
$V_{SAT}$	Saturation voltage		$I_{OUT}=3A$ No outside circuit $V_{FB}=0V$ force driver on		1.4	1.6 <b>1.7</b>	V
DC	Max. Duty Cycle (ON)		$V_{FB}=0V$ force driver on		100		%
	Min. Duty Cycle (OFF)		$V_{FB}=12V$ force driver off		0		
$I_{CL}$	Current limit		Peak current No outside circuit $V_{FB}=0V$ force driver on	3.6	4.5	5.5 6.5	A
$I_{LEAK}$	Output = 0V	Output leakage current	No outside circuit $V_{FB}=12V$ force driver off			-200	uA
	Output = -1V		$V_{IN}=22V$		-5		
$I_Q$	Quiescent Current		$V_{FB}=12V$ force driver off		5	10	mA
$I_{STBY}$	Standby Quiescent Current		ON/OFF pin=5V $V_{IN}=22V$		70	150 <b>200</b>	uA
	$V_{IL}$	ON/OFF pin logic input threshold voltage		Low (regulator ON)	-	0.6	
$V_{IH}$			High (regulator OFF)	2.0	1.3	-	
$I_H$	ON/OFF pin logic input current		$V_{LOGIC}=2.5V$ (OFF)			-0.01	uA
$I_L$	ON/OFF pin input current		$V_{LOGIC}=0.5V$ (ON)		-0.1	-1	
$\theta_{JC}$	Thermal Resistance		TO252-5L	Junction to case		10	°C/W
$\theta_{JA}$	Thermal Resistance With copper area of approximately 2cm x2cm		TO252-5L	Junction to ambient		50	°C/W

Specifications with **boldface type** are for full operating temperature range, the other type are for  $T_J=25^\circ C$ .

### ■ Electrical Characteristics (Continued)

	Symbol	Parameter	Conditions	Typ.	Limit	Unit
AP1507-ADJ	$V_{FB}$	Output Feedback	$5V \leq V_{IN} \leq 22V$ $0.2A \leq I_{LOAD} \leq 3A$ $V_{OUT}$ programmed for 3V	1.23	<b>1.193/1.18</b> <b>1.267/1.28</b>	V $V_{MIN}$ $V_{MAX}$
	$\eta$	Efficiency	$V_{IN} = 12V, I_{LOAD}=3A$	74		%
AP1507-3.3V	$V_{OUT}$	Output voltage	$5.5V \leq V_{IN} \leq 22V$ $0.2A \leq I_{LOAD} \leq 3A$	3.3	<b>3.168/3.135</b> <b>3.432/3.465</b>	V $V_{MIN}$ $V_{MAX}$
	$\eta$	Efficiency	$V_{IN} = 12V, I_{LOAD}=3A$	75		%
AP1507-5V	$V_{OUT}$	Output voltage	$8V \leq V_{IN} \leq 22V$ $0.2A \leq I_{LOAD} \leq 3A$	5	<b>4.8/4.75</b> <b>5.2/5.25</b>	V $V_{MIN}$ $V_{MAX}$
	$\eta$	Efficiency	$V_{IN} = 12V, I_{LOAD}=3A$	80		%
AP1507-12V	$V_{OUT}$	Output voltage	$15V \leq V_{IN} \leq 22V$ $0.2A \leq I_{LOAD} \leq 3A$	12	<b>11.52/11.4</b> <b>12.48/12.6</b>	V $V_{MIN}$ $V_{MAX}$
	$\eta$	Efficiency	$V_{IN} = 16V, I_{LOAD} = 3A$	89		%

Specifications with **boldface type** are for full operating temperature range, the other type are for  $T_j=25^\circ C$ .

### ■ Typical Performance Characteristics

**AP1507 Efficiency v.s. Temperature**  
( $V_{in}=12V, V_{out}=5V, I_o=3A$ )

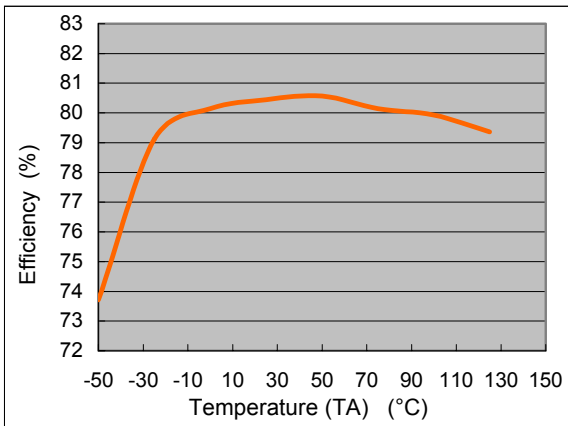

**AP1507 Efficiency v.s. Temperature**  
( $V_{in}=12V, V_{out}=3.3V, I_o=3A$ )

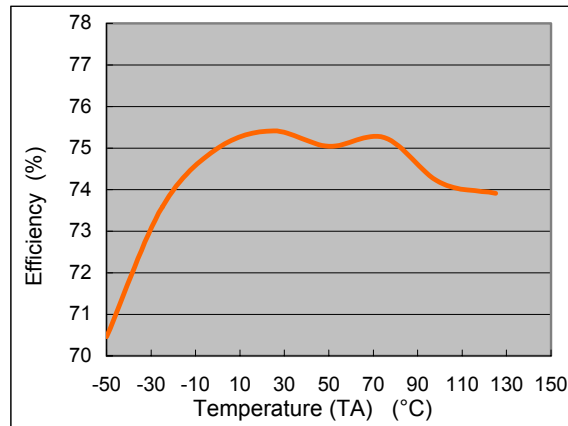

**AP1507 Saturation Voltage v.s. Temperature**  
( $V_{cc}=12V, V_{fb}=0V, V_{SD}=0$ )

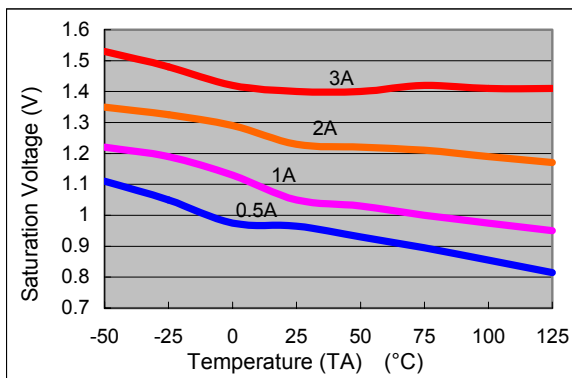

**AP1507 Switch Current Limit v.s. Temperature**  
( $V_{cc}=12V, V_{fb}=0V$ )

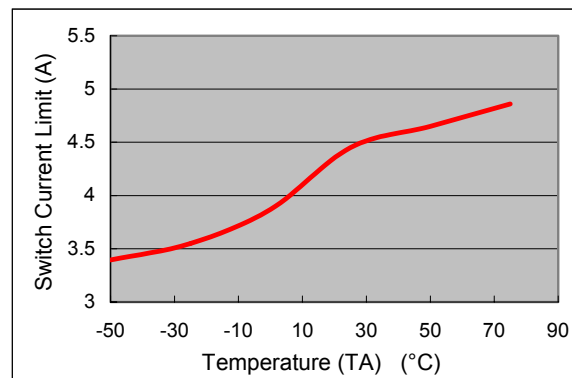

**AP1507 Supply Current v.s. Temperature**  
( $V_{cc}=12V$ , No Load,  $V_{on/off}=0V$ (Switch ON),  $V_{on/off}=5V$ (Switch OFF))

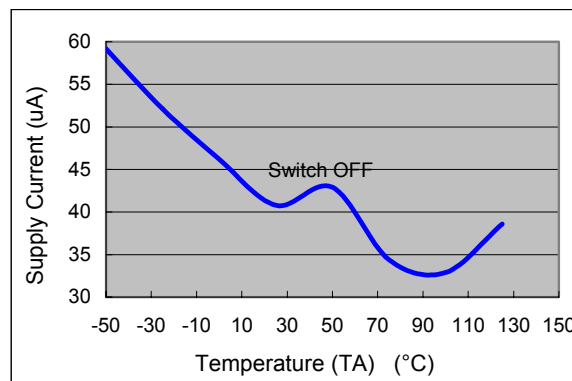
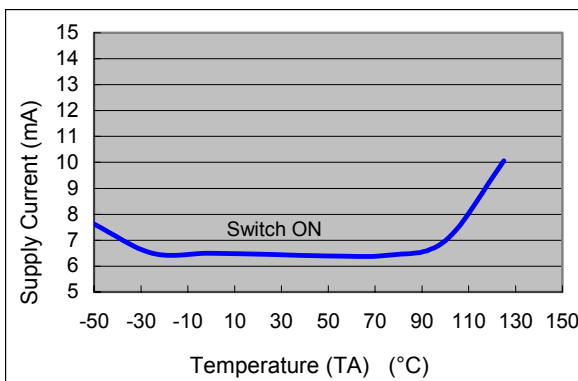

### ■ Typical Performance Characteristics (Continued)

**AP1507 Threshold Voltage v.s. Temperature**  
( $V_{cc}=12V$ ,  $I_o=100mA$ )

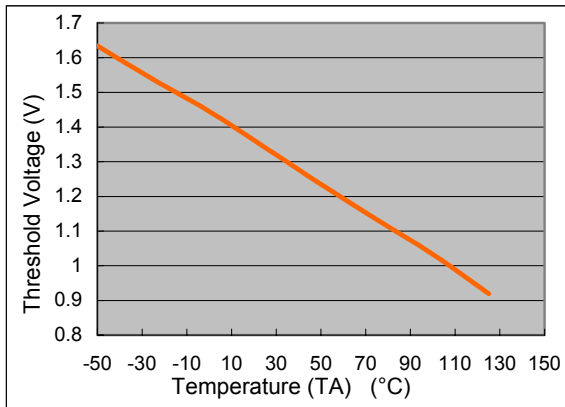

**AP1507 ON/OFF Current v.s. ON/OFF Voltage**  
( $V_{in}=12V$ )

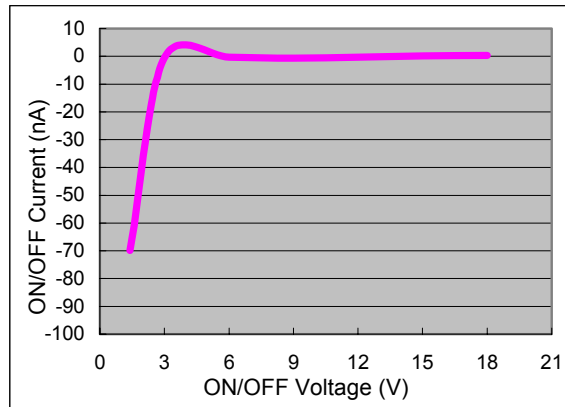

**AP1507 Frequency v.s. Temperature**  
( $V_{cc}=12V$ ,  $I_o=500mA$ ,  $V_{out}=5V$ )

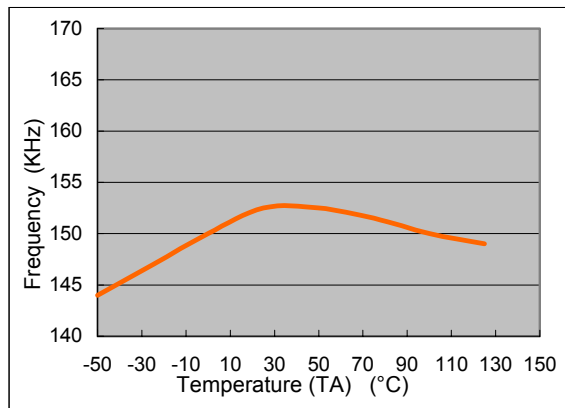

**AP1507 Feedback Current v.s. Temperature**  
( $V_{cc}=12V$ ,  $V_{out}=5V$ ,  $V_{fb}=1.3V$ )

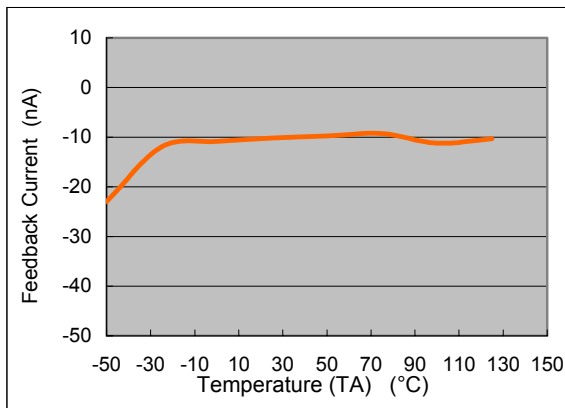

**AP1507 Output Voltage v.s. Temperature**  
( $V_{in}=12V$ ,  $I_o=3A$ )

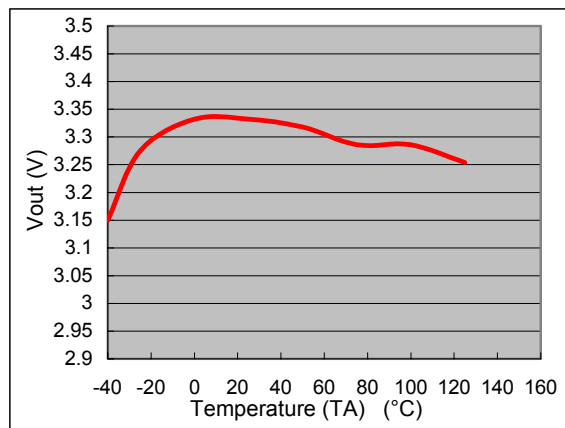

### ■ Typical Application Circuit

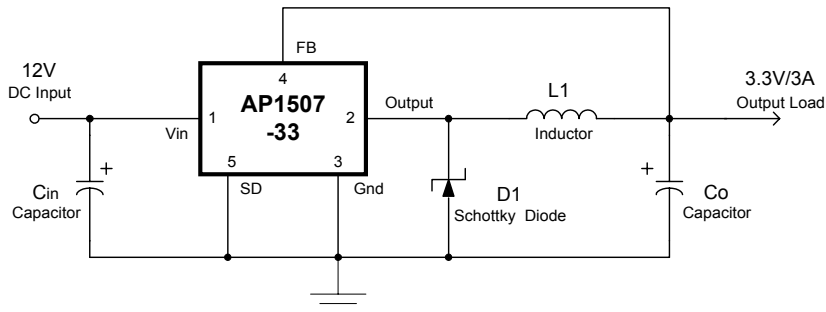

### ■ Function Description

#### Pin Functions

##### +V<sub>IN</sub>

This is the positive input supply for the IC switching regulator. A suitable input bypass capacitor must be present at this pin to minimize voltage transients and to supply the switching currents needed by the regulator.

##### Ground

Circuit ground.

##### Output

Internal switch. The voltage at this pin switches between  $(+V_{IN} - V_{SAT})$  and approximately  $-0.5V$ , with a duty cycle of approximately  $V_{OUT} / V_{IN}$ . To minimize coupling to sensitive circuitry, the PC board copper area connected to this pin should be kept a minimum.

##### Feedback (FB)

Senses the regulated output voltage to complete the feedback loop.

##### ON/OFF (SD)

Allows the switching regulator circuit to be shutdown using logic level signals thus dropping the total input supply current to approximately 150uA. Pulling this pin below a threshold voltage of approximately 1.3V turns the regulator on, and pulling this pin above 1.3V (up to a maximum of 18V) shuts the regulator down. If this shutdown feature is not needed, the ON/OFF pin can be wired to the ground pin or it can be left open, in either case the regulator will be in the ON condition.

#### Thermal Considerations

The TO-252 surface mount package tab is designed to be soldering to the copper on a printed circuit board. The copper and the board are the heat sink for this package and the other heat producing components, such as the catch diode and inductor. The PC board copper area that the package is soldered to should be at least 0.8 in<sup>2</sup>, and ideally should have 2 or more square inches of 2 oz. Additional copper area improves the thermal characteristics, but with copper areas greater than approximately 6 in<sup>2</sup>, only small improvements in heat dissipation are realized. If further thermal improvements are needed, double sided, multi-layer PC board with large copper areas and/or airflow will be recommended.

## 150KHz, 3A PWM Buck DC/DC Converter

### ■ Function Description (Continued)

The AP1507 (TO-252 package) junction temperature rises above ambient temperature with a 3A load for various input and output voltages. This data was taken with the circuit operating as a buck-switching regulator with all components mounted on a PC board to simulate the junction temperature under actual operating conditions. This curve can be used for a quick check for the approximate junction temperature for various conditions, but be aware that there are many factors that can affect the junction temperature. When load currents higher than 3A are used, double sided or multi-layer PC boards with large copper areas and/or airflow might be needed, especially for high ambient temperatures and high output voltages.

For the best thermal performance, wide copper traces and generous amounts of printed circuit board copper should be used in the board layout. (Once exception to this is the output (switch) pin, which should not have large areas of copper.) Large areas of copper provide the best transfer of heat (lower thermal resistance) to the surrounding

air, and moving air lowers the thermal resistance even further.

Package thermal resistance and junction temperature rise numbers are all approximate, and there are many factors that will affect these numbers. Some of these factors include board size, shape, thickness, position, location, and even board temperature. Other factors are, trace width, total printed circuit copper area, copper thickness, single or double-sided, multi-layer board and the amount of solder on the board. The effectiveness of the PC board to dissipate heat also depends on the size, quantity and spacing of other components on the board, as well as whether the surrounding air is still or moving. Furthermore, some of these components such as the catch diode will add heat to the PC board and the heat can vary as the input voltage changes. For the inductor, depending on the physical size, type of core material and the DC resistance, it could either act as a heat sink taking heat away from the board, or it could add heat to the board.

### ■ Marking Information

#### TO252-5L

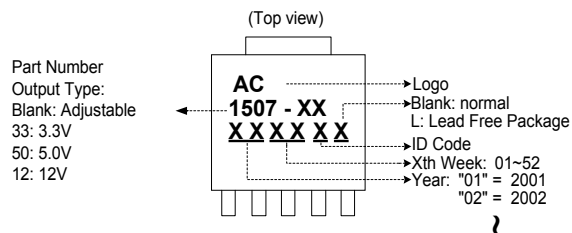



### ■ Package Information

Package Type: TO252-5L

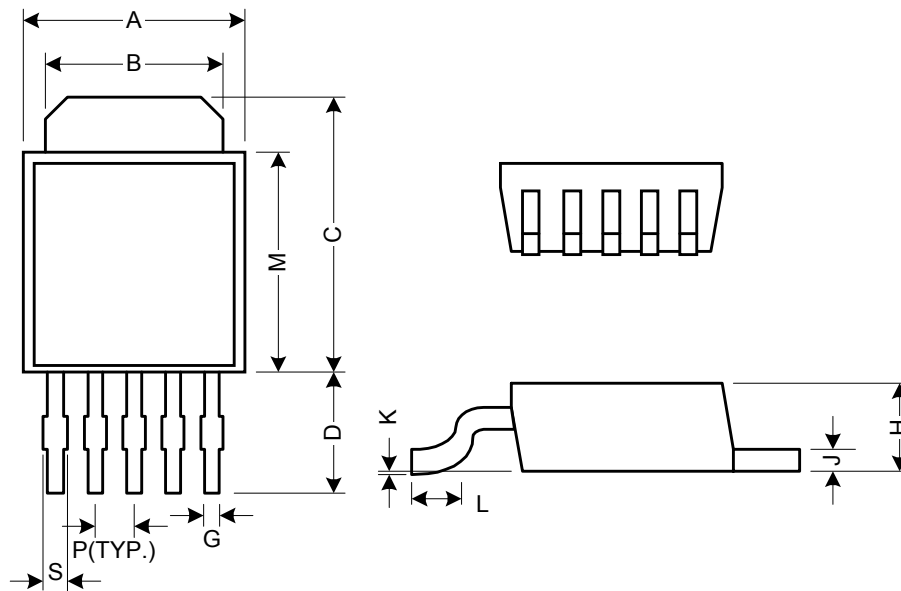

Symbol	Dimensions In Millimeters			Dimensions In Inches		
	Min.	Nom.	Max.	Min.	Nom.	Max.
A	6.35	6.60	6.85	0.250	0.260	0.270
B	5.20	5.35	5.50	0.205	0.211	0.217
C	6.80	7.00	7.20	0.268	0.276	0.283
D	2.20	2.50	2.80	0.087	0.098	0.110
P	1.27 REF.			0.050 REF.		
S	0.50	0.65	0.80	0.020	0.026	0.031
G	0.40	0.50	0.60	0.016	0.020	0.024
H	2.20	2.30	2.40	0.087	0.091	0.094
J	0.46	0.52	0.58	0.018	0.020	0.023
K	0.00	0.08	0.15	0.000	0.003	0.006
L	0.90	1.20	1.50	0.035	0.047	0.059
M	5.40	5.50	5.59	0.213	0.216	0.220