

IRF6655

DirectFET™ Power MOSFET ②

Typical values (unless otherwise specified)

V_{DSS}	V_{GS}	R_{DS(on)}
100V max	±20V max	53mΩ @ 10V
Q_{g tot}	Q_{gd}	V_{gs(th)}
8.7nC	2.8nC	3.9V

- Lead and Bromide Free ①
- Low Profile (<0.7 mm)
- Dual Sided Cooling Compatible ①
- Ultra Low Package Inductance
- Optimized for High Frequency Switching ①
- Ideal for High Performance Isolated Converter Primary Switch Socket
- Ideal for Control FET sockets in 36V – 75V in Synchronous Buck applications
- Low Conduction Losses
- Compatible with existing Surface Mount Techniques ①

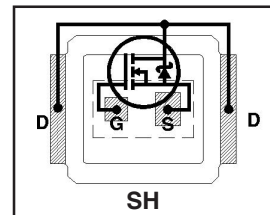

Applicable DirectFET Outline and Substrate Outline (see p.7,8 for details)①

SQ	SX	ST	SH	MQ	MX	MT	MN		
----	----	----	-----------	----	----	----	----	--	--

Description

The IRF6655 combines the latest HEXFET® Power MOSFET Silicon technology with the advanced DirectFET™ packaging to achieve the lowest combined on-state resistance and gate charge in a package that has a footprint similar to that of a micro-8, and only 0.7mm profile. The DirectFET package is compatible with existing layout geometries used in power applications, PCB assembly equipment and vapor phase, infrared or convection soldering techniques, when application note AN-1035 is followed regarding the manufacturing methods and processes. The DirectFET package allows dual sided cooling to maximize thermal transfer in power systems, improving previous best thermal resistance by 80%.

The IRF6655 is optimized for low power primary side bridge topologies in isolated DC-DC applications, and for high side control FET sockets in non-isolated synchronous buck DC-DC applications for use in wide range universal Telecom systems (36V – 75V), and for secondary side synchronous rectification in regulated DC-DC topologies. The reduced total losses in the device coupled with the high level of thermal performance enables high efficiency and low temperatures, which are key for system reliability improvements, and makes this device ideal for high performance isolated DC-DC converters.

Absolute Maximum Ratings

	Parameter	Max.	Units
V _{DS}	Drain-to-Source Voltage	100	V
V _{GS}	Gate-to-Source Voltage	±20	
I _D @ T _A = 25°C	Continuous Drain Current, V _{GS} @ 10V ⑥	4.2	A
I _D @ T _A = 70°C	Continuous Drain Current, V _{GS} @ 10V ⑥	3.4	
I _D @ T _C = 25°C	Continuous Drain Current, V _{GS} @ 10V ⑥	19	
I _{DM}	Pulsed Drain Current ③	34	
E _{AS}	Single Pulse Avalanche Energy ④	11	mJ
I _{AR}	Avalanche Current ③	5.0	A

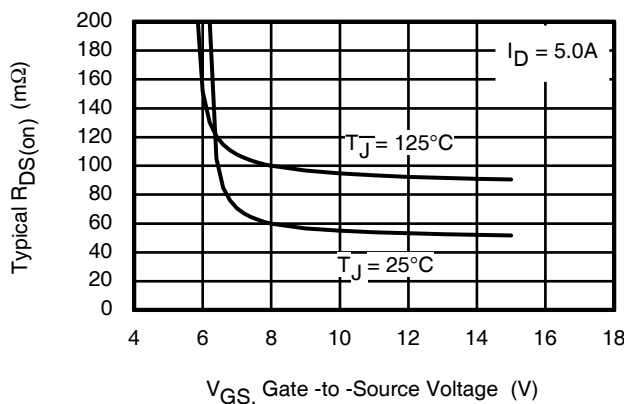

Fig 1. Typical On-Resistance Vs. Gate Voltage

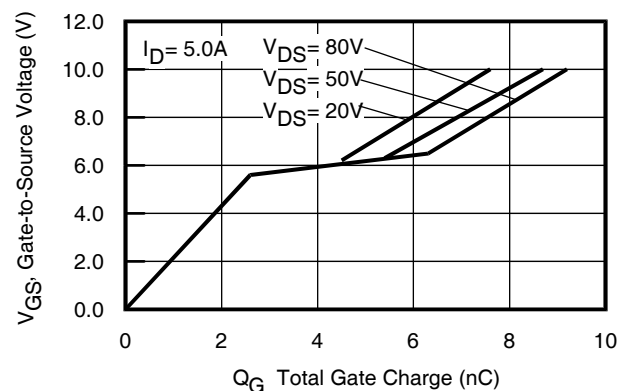

Fig 2. Typical On-Resistance Vs. Gate Voltage

Notes:

- ① Click on this section to link to the appropriate technical paper.
- ② Click on this section to link to the DirectFET MOSFETs
- ③ Repetitive rating; pulse width limited by max. junction temperature.

- ④ Starting T_J = 25°C, L = 0.89mH, R_G = 25Ω, I_{AS} = 5.0A.
- ⑥ Surface mounted on 1 in. square Cu board, steady state.
- ⑦ T_C measured with thermocouple mounted to top (Drain) of part.

Static @ T_J = 25°C (unless otherwise specified)

	Parameter	Min.	Typ.	Max.	Units	Conditions
BV _{DSS}	Drain-to-Source Breakdown Voltage	100	—	—	V	V _{GS} = 0V, I _D = 250μA
ΔBV _{DSS} /ΔT _J	Breakdown Voltage Temp. Coefficient	—	0.12	—	V/°C	Reference to 25°C, I _D = 1mA
R _{DS(on)}	Static Drain-to-Source On-Resistance	—	53	62	mΩ	V _{GS} = 10V, I _D = 5.0A ⑤
V _{GS(th)}	Gate Threshold Voltage	2.8	—	4.8	V	V _{DS} = V _{GS} , I _D = 25μA
ΔV _{GS(th)} /ΔT _J	Gate Threshold Voltage Coefficient	—	-11	—	mV/°C	
I _{DSS}	Drain-to-Source Leakage Current	—	—	20	μA	V _{DS} = 100V, V _{GS} = 0V
		—	—	250		V _{DS} = 80V, V _{GS} = 0V, T _J = 125°C
I _{GSS}	Gate-to-Source Forward Leakage	—	—	100	nA	V _{GS} = 20V
	Gate-to-Source Reverse Leakage	—	—	-100		V _{GS} = -20V
gfs	Forward Transconductance	6.6	—	—	S	V _{DS} = 10V, I _D = 5.0A
Q _g	Total Gate Charge	—	8.7	11.7		V _{DS} = 50V V _{GS} = 10V I _D = 5.0A See Fig. 17
Q _{gs1}	Pre-V _{th} Gate-to-Source Charge	—	2.1	—	nC	
Q _{gs2}	Post-V _{th} Gate-to-Source Charge	—	0.58	—		
Q _{gd}	Gate-to-Drain Charge	—	2.8	4.2		
Q _{godr}	Gate Charge Overdrive	—	3.2	—		
Q _{sw}	Switch Charge (Q _{gs2} + Q _{gd})	—	3.4	—		
Q _{oss}	Output Charge	—	4.5	—	nC	V _{DS} = 16V, V _{GS} = 0V
R _G	Gate Resistance	—	1.9	2.9	Ω	
t _{d(on)}	Turn-On Delay Time	—	7.4	—	ns	V _{DD} = 50V, V _{GS} = 10V ⑤ I _D = 5.0A R _G = 6.0Ω
t _r	Rise Time	—	2.8	—		
t _{d(off)}	Turn-Off Delay Time	—	14	—		
t _f	Fall Time	—	4.3	—		
C _{iss}	Input Capacitance	—	530	—	pF	V _{GS} = 0V V _{DS} = 25V f = 1.0MHz
C _{oss}	Output Capacitance	—	110	—		
C _{riss}	Reverse Transfer Capacitance	—	29	—		
C _{oss}	Output Capacitance	—	510	—		
C _{oss}	Output Capacitance	—	67	—		
						V _{GS} = 0V, V _{DS} = 80V, f = 1.0MHz

Diode Characteristics

	Parameter	Min.	Typ.	Max.	Units	Conditions
I _S	Continuous Source Current (Body Diode)	—	—	4.2	A	MOSFET symbol showing the integral reverse p-n junction diode.
I _{SM}	Pulsed Source Current (Body Diode) ③	—	—	34		
V _{SD}	Diode Forward Voltage	—	—	1.3	V	T _J = 25°C, I _S = 5.0A, V _{GS} = 0V ⑤
t _{rr}	Reverse Recovery Time	—	31	47	ns	T _J = 25°C, I _F = 5.0A, V _{DD} = 25V
Q _{rr}	Reverse Recovery Charge	—	37	56	nC	di/dt = 100A/μs ⑤

Notes:

⑤ Pulse width ≤ 400μs; duty cycle ≤ 2%.

Absolute Maximum Ratings

	Parameter	Max.	Units
$P_D @ T_A = 25^\circ\text{C}$	Power Dissipation ⑥	2.2	W
$P_D @ T_A = 70^\circ\text{C}$	Power Dissipation ⑥	1.4	
$P_D @ T_C = 25^\circ\text{C}$	Power Dissipation ⑥	42	
T_P	Peak Soldering Temperature	270	°C
T_J	Operating Junction and	-40 to +150	
T_{STG}	Storage Temperature Range		

Thermal Resistance

	Parameter	Typ.	Max.	Units
$R_{\theta JA}$	Junction-to-Ambient ⑥⑩	—	58	°C/W
$R_{\theta JA}$	Junction-to-Ambient ⑦⑩	12.5	—	
$R_{\theta JA}$	Junction-to-Ambient ⑧⑩	20	—	
$R_{\theta JC}$	Junction-to-Case ⑨⑩	—	3.0	
$R_{\theta J-PCB}$	Junction-to-PCB Mounted	1.4	—	

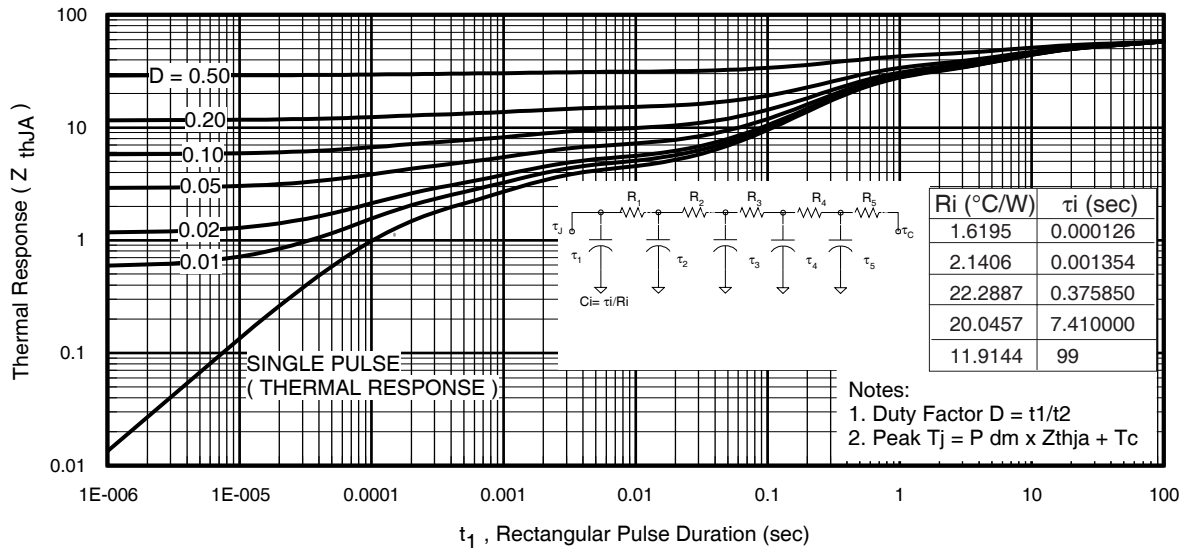
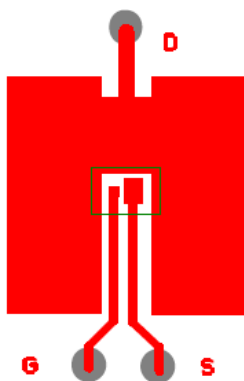

Fig 3. Maximum Effective Transient Thermal Impedance, Junction-to-Ambient

Notes:

- ⑥ Surface mounted on 1 in. square Cu board, steady state.
- ⑦ Used double sided cooling, mounting pad.
- ⑧ Mounted on minimum footprint full size board with metalized back and with small clip heatsink.
- ⑨ T_C measured with thermocouple incontact with top (Drain) of part.
- ⑩ R_{θ} is measured at T_J of approximately 90°C .



⑥ Surface mounted on 1 in. square Cu board (still air).

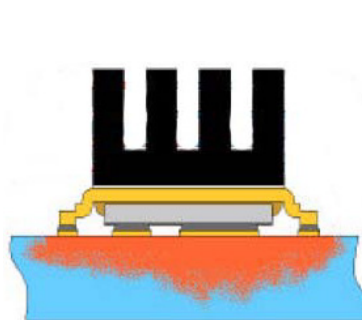

⑦ Mounted to a PCB with a thin gap filler and heat sink. (still air)

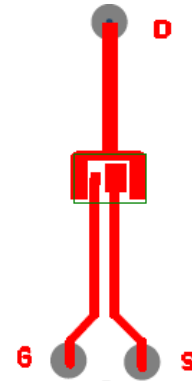

⑧ Mounted on minimum footprint full size board with metalized back and with small clip heatsink (still air)

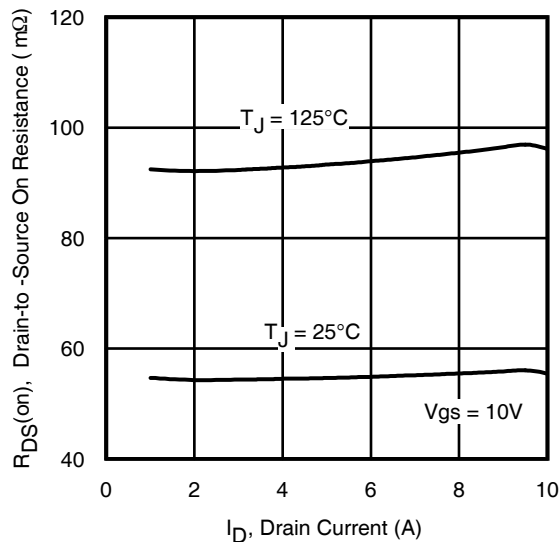
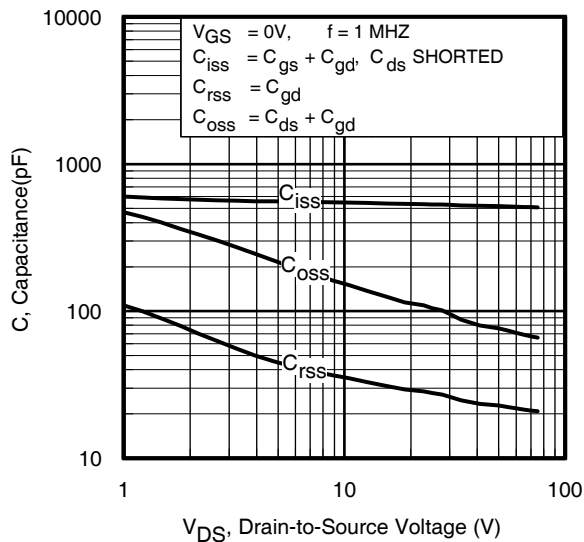
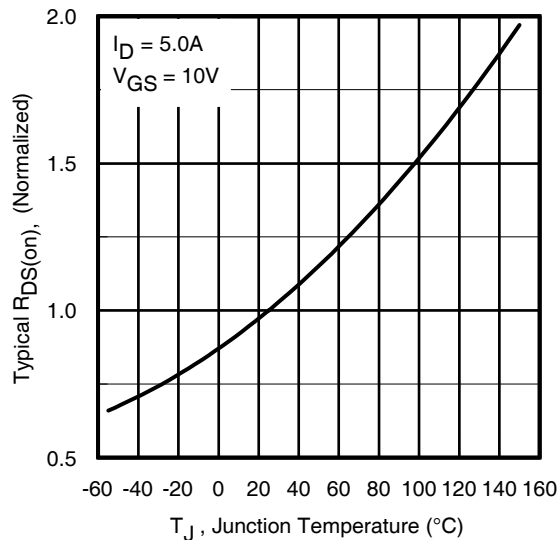
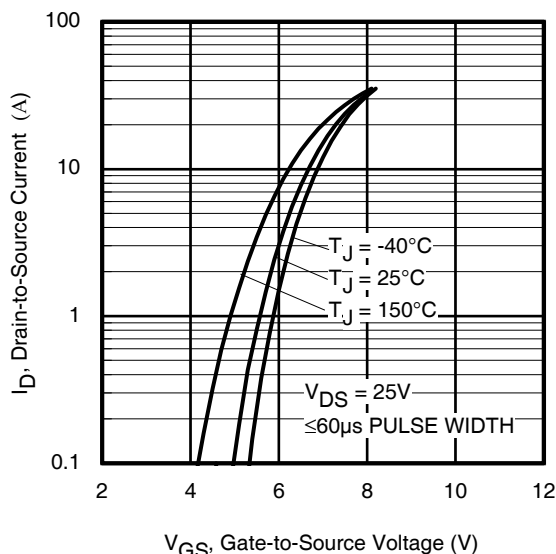
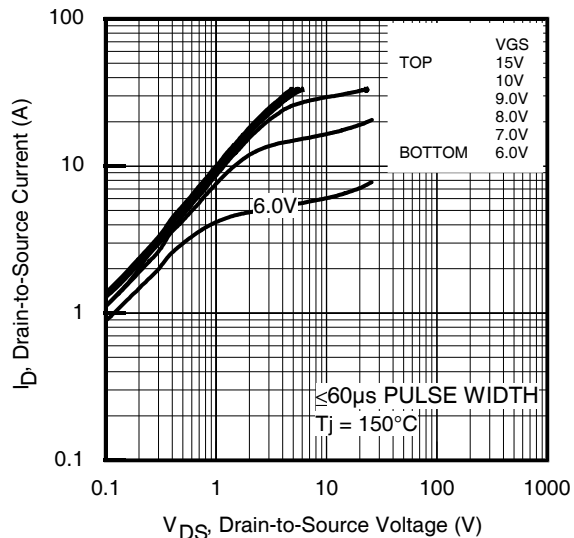
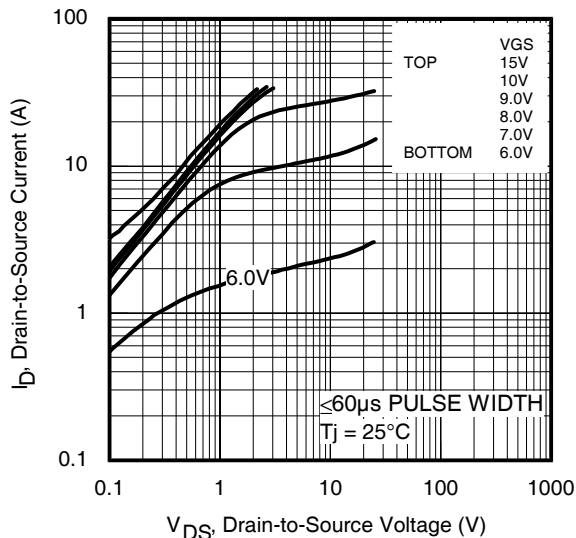

Fig 8. Typical Capacitance vs. Drain-to-Source Voltage

Fig 9. Normalized Typical On-Resistance vs. Drain Current and Gate Voltage

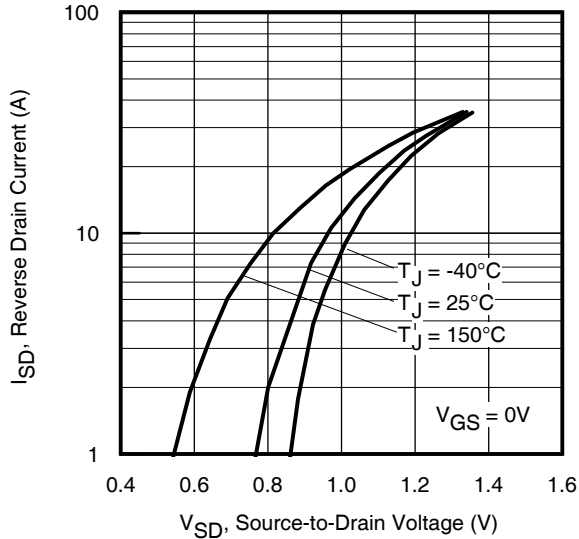

Fig 10. Typical Source-Drain Diode Forward Voltage

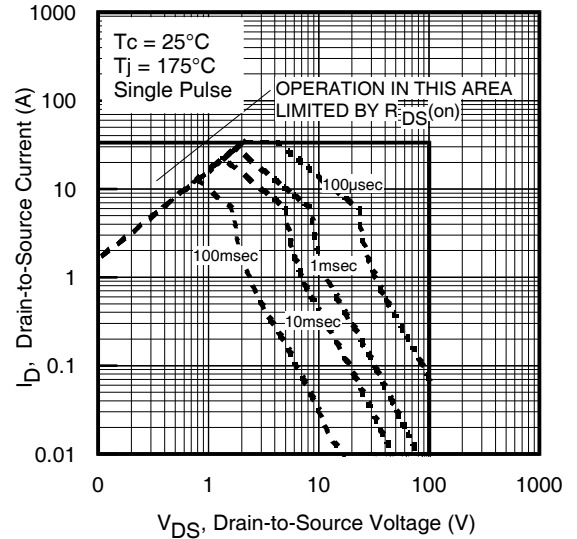

Fig11. Maximum Safe Operating Area

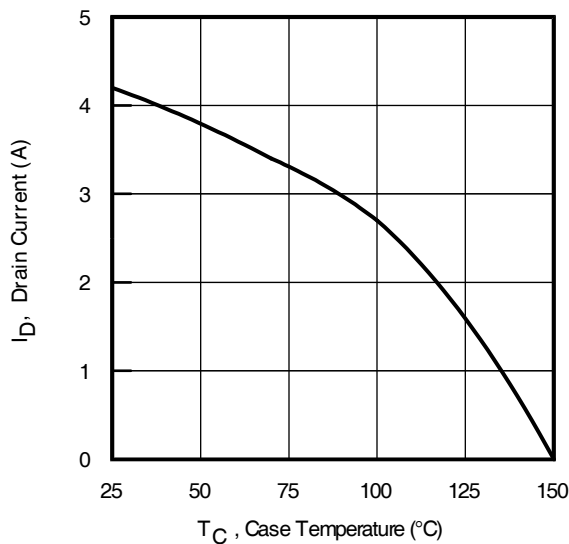

Fig 12. Maximum Drain Current vs. Case Temperature

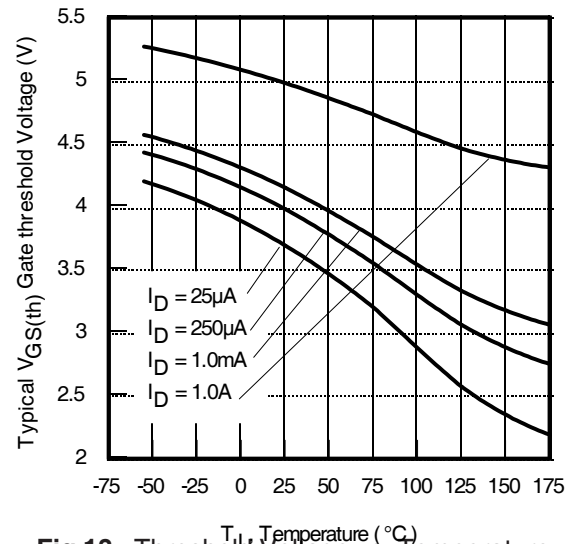

Fig 13. Threshold Voltage vs. Temperature

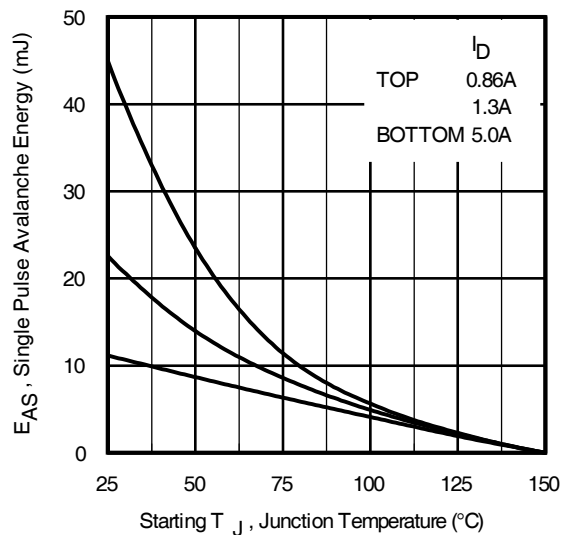

Fig 14. Maximum Avalanche Energy vs. Drain Current

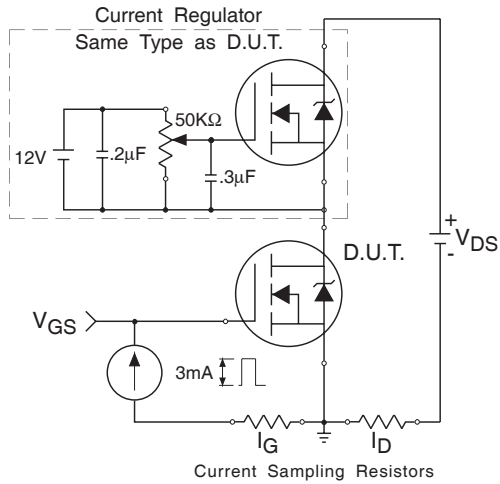

Fig 15a. Gate Charge Test Circuit

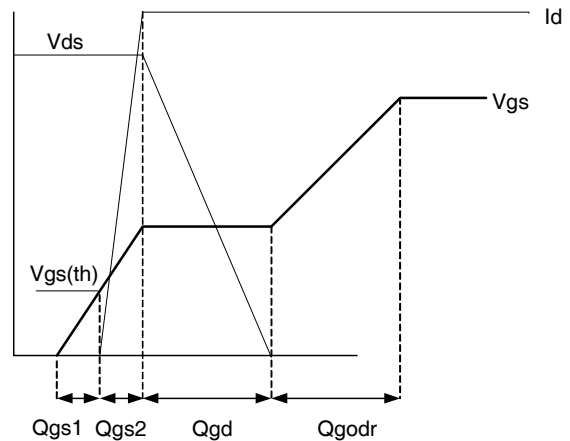

Fig 15b. Gate Charge Waveform

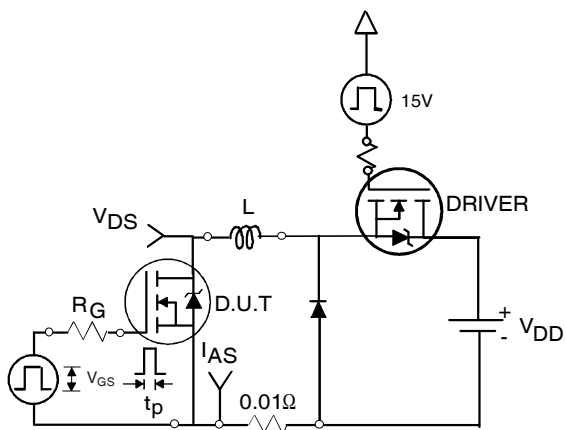

Fig 16b. Unclamped Inductive Test Circuit

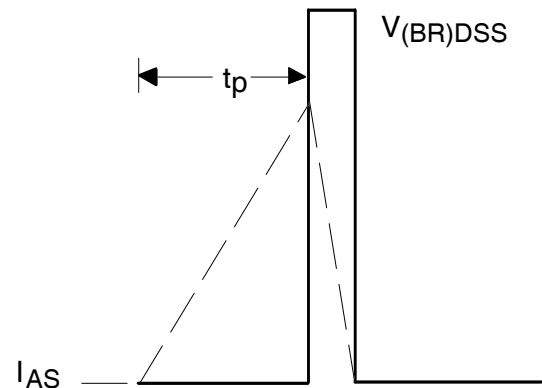

Fig 16c. Unclamped Inductive Waveforms

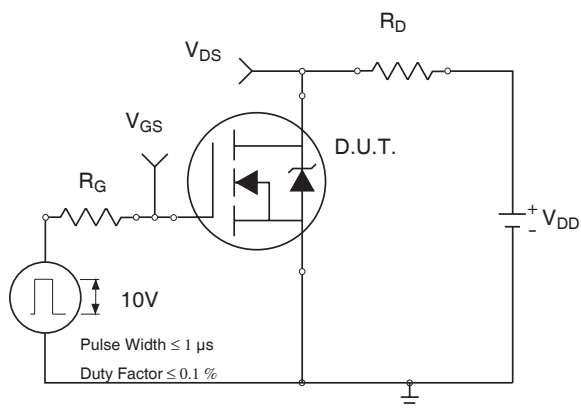

Fig 17a. Switching Time Test Circuit

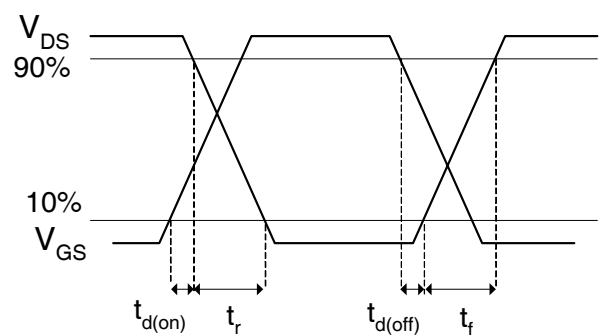

Fig 17b. Switching Time Waveforms

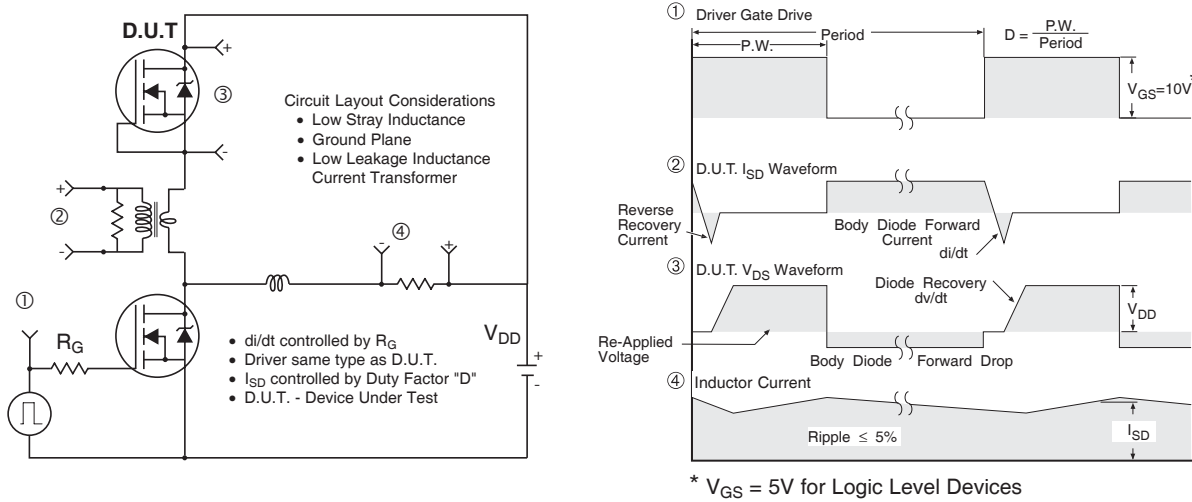
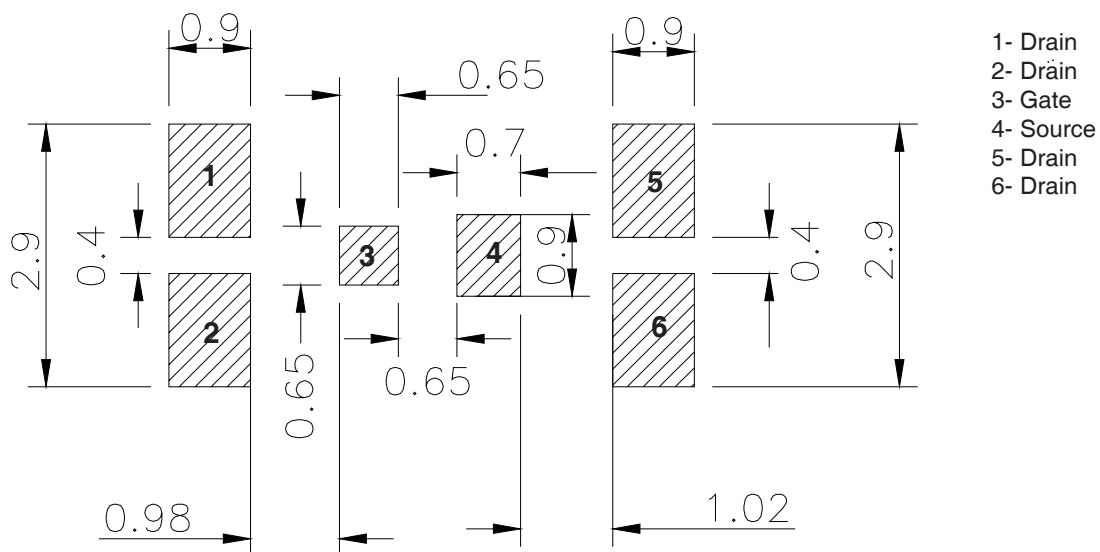

Fig 18. Diode Reverse Recovery Test Circuit for N-Channel HEXFET® Power MOSFETs

DirectFET™ Substrate and PCB Layout, SH Outline (Small Size Can, H-Designation).

Please see DirectFET application note AN-1035 for all details regarding PCB assembly using DirectFET. This includes all recommendations for stencil and substrate designs.



IRF6655

DirectFET™ Outline Dimension, SH Outline (Small Size Can, H-Designation).

Please see DirectFET application note AN-1035 for all details regarding PCB assembly using DirectFET. This includes all recommendations for stencil and substrate designs.

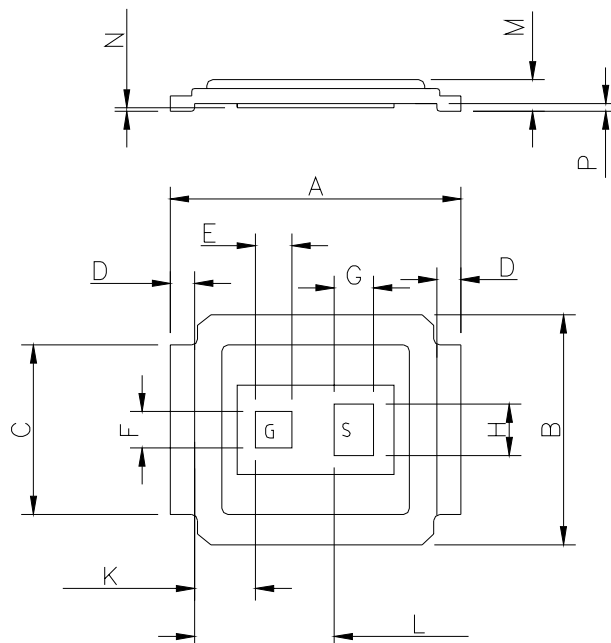

Note: Controlling dimensions are in mm.

CODE	DIMENSIONS		DIMENSIONS	
	METRIC		IMPERIAL	
	MIN	MAX	MIN	MAX
A	4.75	4.85	0.187	0.191
B	3.70	3.95	0.146	0.156
C	2.75	2.85	0.108	0.112
D	0.35	0.45	0.014	0.018
E	0.58	0.62	0.023	0.024
F	0.58	0.62	0.023	0.024
G	0.63	0.67	0.025	0.026
H	0.83	0.87	0.033	0.034
K	0.99	1.03	0.039	0.041
L	2.29	2.33	0.090	0.092
M	0.48	0.58	0.019	0.023
N	0.03	0.08	0.001	0.003
P	0.08	0.17	0.003	0.007

DirectFET™ Part Marking

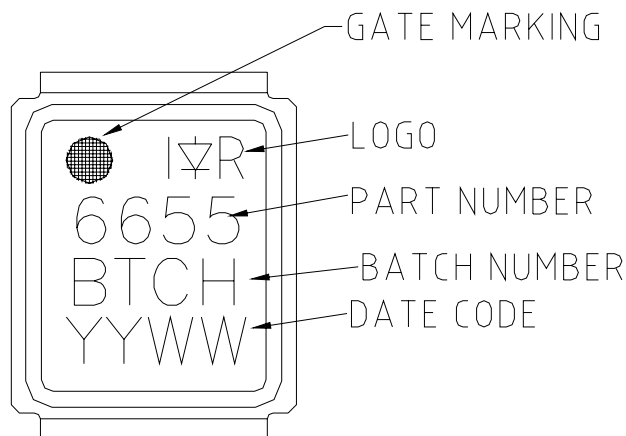

DirectFET™ Tape & Reel Dimension (Showing component orientation).

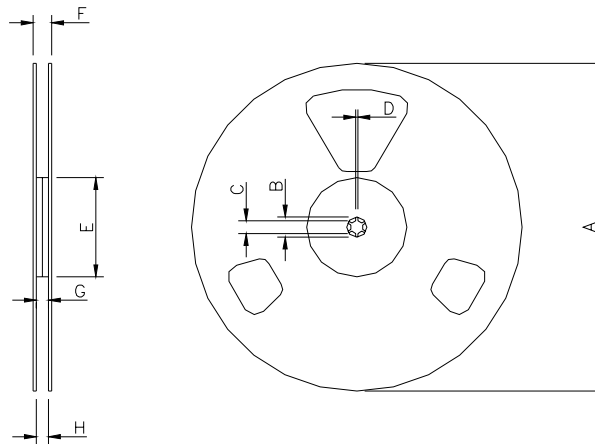

NOTE: Controlling dimensions in mm
 Std reel quantity is 4800 parts. (ordered as IRF6655). For 1000 parts on 7" reel,
 order IRF6655TR1

REEL DIMENSIONS							
CODE	STANDARD OPTION (QTY 4800)			TR1 OPTION (QTY 1000)			
	METRIC		IMPERIAL	METRIC		IMPERIAL	
	MIN	MAX	MIN	MIN	MAX	MIN	MAX
A	330.0	N.C	12.992	177.77	N.C	6.9	N.C
B	20.2	N.C	0.795	19.06	N.C	0.75	N.C
C	12.8	13.2	0.504	13.5	12.8	0.53	0.50
D	1.5	N.C	0.059	1.5	N.C	0.059	N.C
E	100.0	N.C	3.937	58.72	N.C	2.31	N.C
F	N.C	18.4	N.C	N.C	13.50	N.C	0.53
G	12.4	14.4	0.488	11.9	12.01	0.47	N.C
H	11.9	15.4	0.469	11.9	12.01	0.47	N.C

Loaded Tape Feed Direction

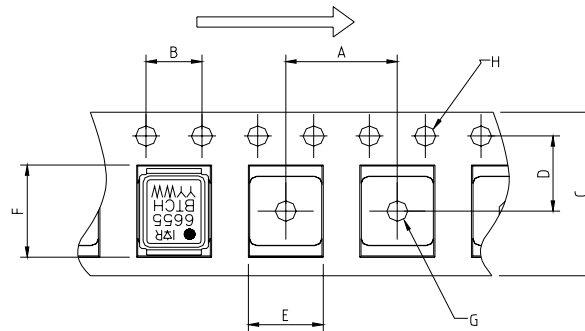

NOTE: CONTROLLING
 DIMENSIONS IN MM

CODE	DIMENSIONS		
	METRIC	MIN	MAX
A	8.10	0.311	0.319
B	4.10	0.154	0.161
C	12.30	0.469	0.484
D	5.55	0.215	0.219
E	5.30	0.201	0.209
F	6.70	0.256	0.264
G	N.C	0.059	N.C
H	1.60	0.059	0.063

Data and specifications subject to change without notice.
 This product has been designed and qualified for the Consumer market.
 Qualification Standards can be found on IR's Web site.