

## WBFBP-02L Plastic-Encapsulate Diodes

### DS160-40THD02

SCHOTTKY BARRIER DIODE

#### WBFBP-02L

(1.6×0.8×0.5)

unit:mm

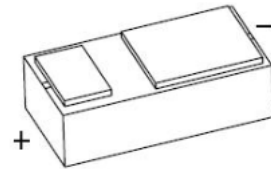

#### FEATURES

- Low forward voltage drop
- Small power mold type
- Low  $I_R$
- Small current rectification

#### APPLICATIONS

- Low voltage rectification
- High efficiency DC-to-DC conversion
- Switch mode power supply
- LED backlight for mobile application
- Low power consumption applications
- Ultra high-speed switching
- Reverse polarity protection

MARKING: -  +

#### MAXIMUM RATINGS ( $T_a=25^\circ\text{C}$ unless otherwise noted )

Symbol	Parameter	Value	Unit
$V_{RRM}$	Peak Repetitive Reverse Voltage	40	V
$V_{RWM}$	Working Peak Reverse Voltage		
$V_{R(RMS)}$	RMS Reverse Voltage	28	V
$I_O$	Average Rectified Output Current	1	A
$I_{FSM}$	Non-repetitive Peak Forward Surge Current @ $t=8.3\text{ms}$	5	A
$P_D$	Power Dissipation	150	mW
$R_{\theta JA}$	Thermal Resistance from Junction to Ambient	667	$^\circ\text{C}/\text{W}$
$T_j$	Junction Temperature	125	$^\circ\text{C}$
$T_{stg}$	Storage Temperature	-55~+150	$^\circ\text{C}$

#### ELECTRICAL CHARACTERISTICS( $T_a=25^\circ\text{C}$ unless otherwise specified)

Parameter	Symbol	Test conditions	Min	Typ	Max	Unit
Reverse voltage	$V_{(BR)}$	$I_R=10\mu\text{A}$	40			V
Reverse current	$I_R$	$V_R=40\text{V}$			50	$\mu\text{A}$
Forward voltage	$V_F$	$I_F=0.7\text{A}$			0.55	V
Diode capacitance	$C_d$	$V_R=1\text{V}; f=1\text{MHz}; T_j=25^\circ\text{C}$		50		pF
		$V_R=10\text{V}; f=1\text{MHz}; T_j=25^\circ\text{C}$		20		pF
Reverse recovery time	$t_{rr}$	$I_F=I_R=10\text{mA}; R_L=100\Omega;$ $I_{R(\text{meas})}=1\text{mA}$		15		ns

# Typical Characteristics

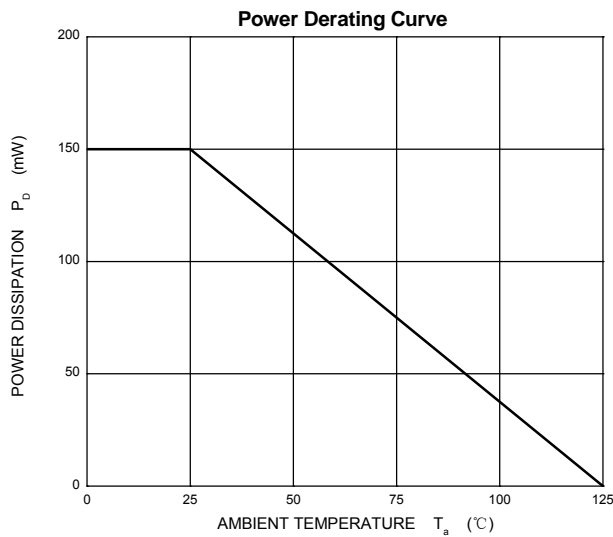
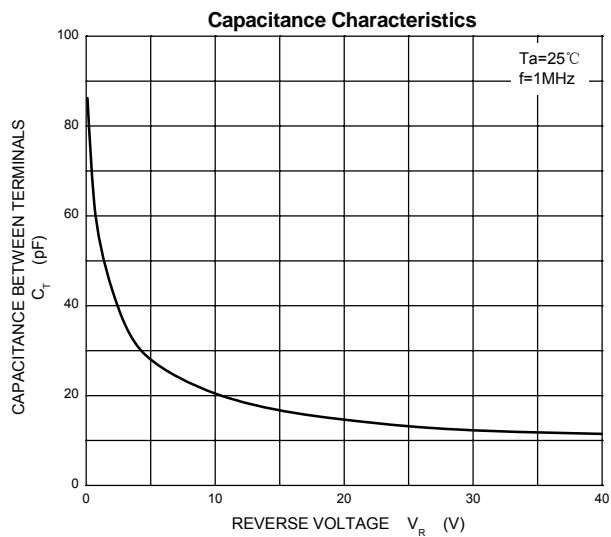
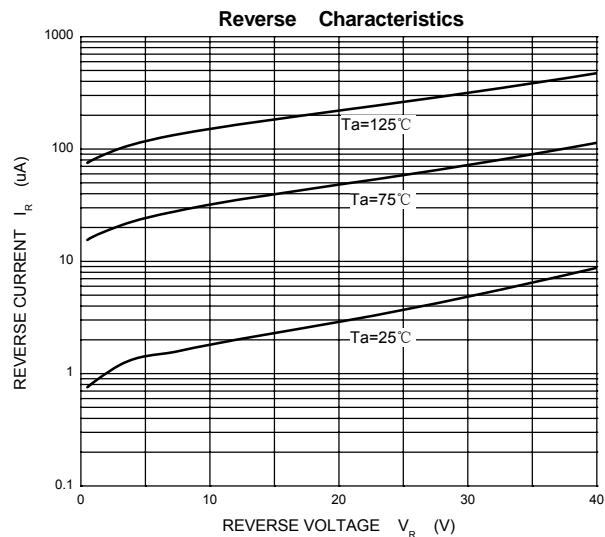
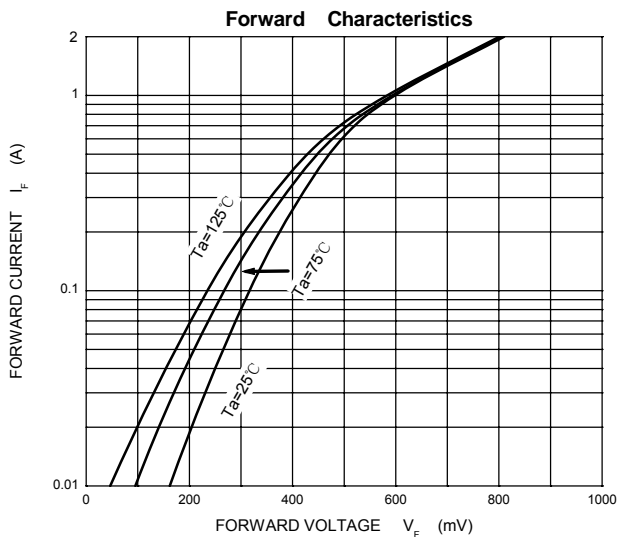

## WBFBP-02L(1.6X0.8X0.5) Package Outline Dimensions

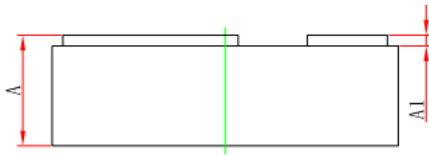
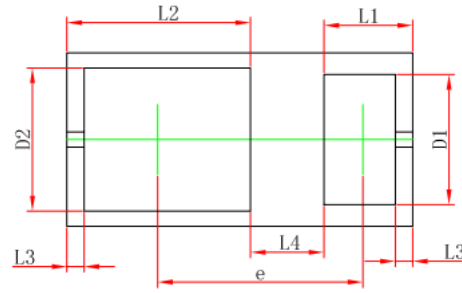
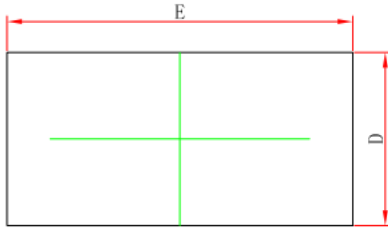

Symbol	Dimensions In Millimeters		Dimensions In Inches	
	Min.	Max.	Min.	Max.
A	0.450	0.550	0.018	0.022
A1	0.010	0.090	0.000	0.004
D	0.750	0.850	0.030	0.033
D1	0.520	0.680	0.020	0.027
D2	0.600	0.760	0.024	0.030
E	1.550	1.650	0.061	0.065
L1	0.410 REF.		0.016 REF.	
L2	0.850 REF.		0.033 REF.	
L3	0.080 REF.		0.003 REF.	
L4	0.340 REF.		0.013 REF.	
e	0.900	1.000	0.035	0.039

## WBFBP-02L(1.6X0.8X0.5) Suggested Pad Layout

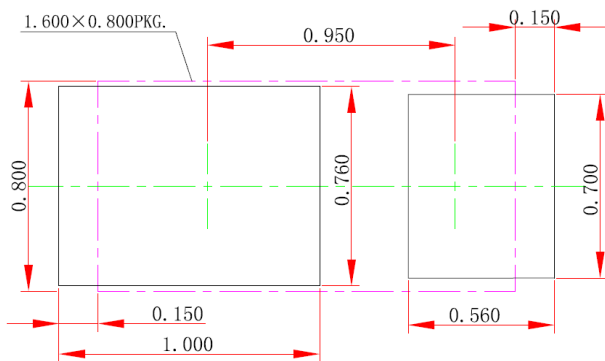

### Note:

1. Controlling dimension: in millimeters.
2. General tolerance:  $\pm 0.050$  mm.
3. The pad layout is for reference purposes only.

### NOTICE

JCET reserve the right to make modifications, enhancements, improvements, corrections or other changes without further notice to any product herein. JCET does not assume any liability arising out of the application or use of any product described herein.

# WBFB-02L(1.6X0.8X0.5) Tape and Reel

## WBFBP-02L(1.6×0.8×0.5) Embossed Carrier Tape

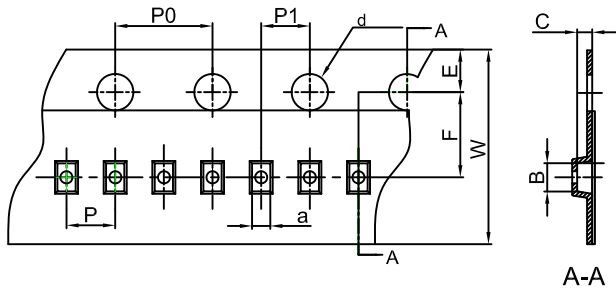

### Packaging Description:

WBFBP-02L(1.6×0.8×0.5) parts are shipped in tape. The carrier tape is made from a dissipative (carbon filled) polycarbonate resin. The cover tape is a multilayer film (Heat Activated Adhesive in nature) primarily composed of polyester film, adhesive layer, sealant, and anti-static sprayed agent. These reeled parts in standard option are shipped with 10,000 units per 7" or 17.8cm diameter reel. The reels are clear in color and is made of polystyrene plastic (anti-static coated).

Dimensions are in millimeter										
Pkg type	a	B	C	d	E	F	P0	P	P1	W
WBFBP-02L(1.6×0.8×0.5)	0.90	1.75	0.66	Ø1.50	1.75	3.50	4.00	2.00	2.00	8.00

## WBFBP-02L(1.6×0.8×0.5) Tape Leader and Trailer

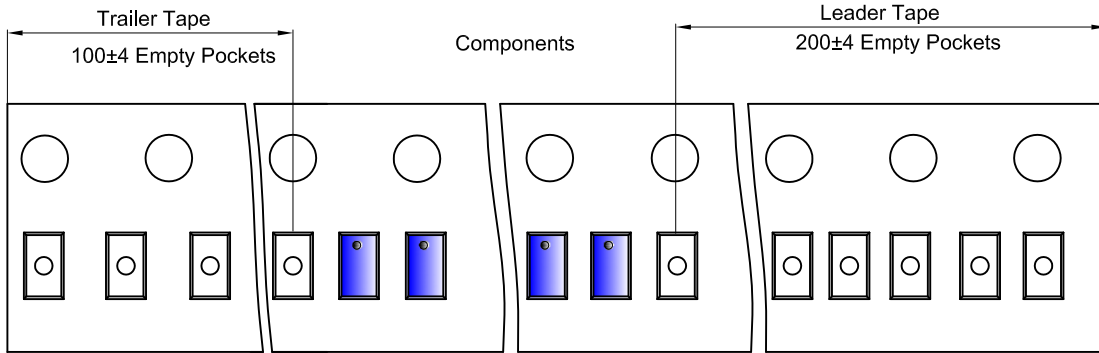

## WBFBP-02L(1.6×0.8×0.5) Reel

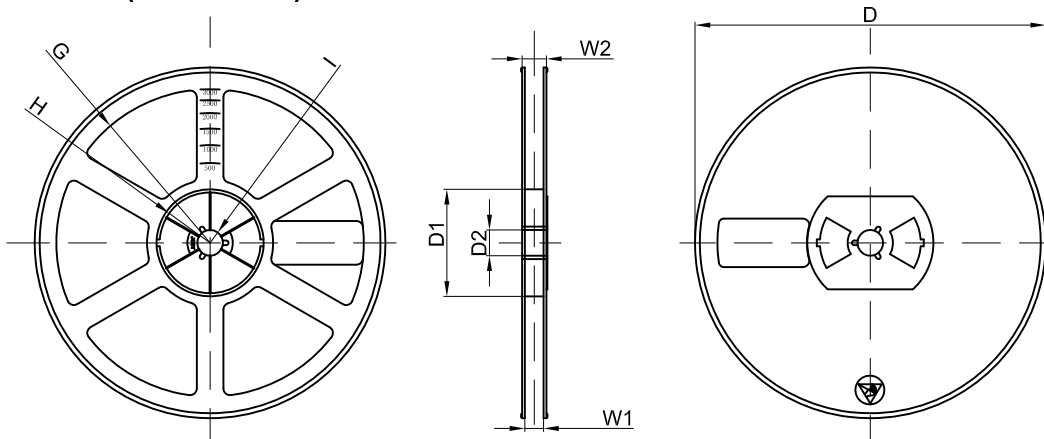

Dimensions are in millimeter								
Reel Option	D	D1	D2	G	H	I	W1	W2
7" Dia	Ø178.00	54.40	13.00	R78.00	R25.60	R6.50	9.50	12.30

REEL	Reel Size	Box	Box Size(mm)	Carton	Carton Size(mm)	G.W.(kg)
10000 pcs	7 inch	150,000 pcs	203×203×195	600,000 pcs	438×438×220	