

**ZXTN25100BFH**

**100V NPN LOW SATURATION TRANSISTOR IN SOT23**

**Features**

- $BV_{CEO} > 100V$
- $BV_{CEX} > 170V$  forward blocking voltage
- $BV_{ECO} > 6V$  reverse blocking voltage
- $I_C = 3A$  high Continuous Collector Current
- Low saturation voltage,  $V_{CE(SAT)} < 80mV @ 1A$
- $R_{CE(SAT)} = 67m\Omega$  for a low equivalent On-Resistance
- 1.25W Power dissipation
- $h_{FE}$  specified up to 3A for high current gain hold up
- Complementary PNP Type: ZXP25100BFH
- **Totally Lead-Free & Fully RoHS compliant (Notes 1 & 2)**
- **Halogen and Antimony Free. "Green" Device (Note 3)**
- **Qualified to AEC-Q101 Standards for High Reliability**

**Mechanical Data**

- Case: SOT23
- Case Material: molded plastic, "Green" molding compound
- UL Flammability Classification Rating 94V-0
- Moisture Sensitivity: Level 1 per J-STD-020
- Terminals: Finish – Matte Tin Plated Leads, Solderable per MIL-STD-202, Method 208 (E3)
- Weight 0.008 grams (approximate)

**Applications**

- Lamp relay and solenoid drivers
- General switching in automotive and industrial applications
- Motor drive and control

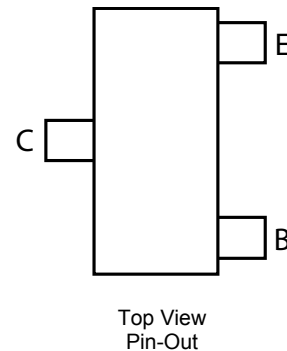
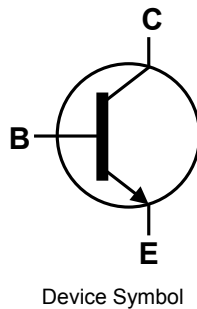

**Ordering Information** (Note 4)

Product	Marking	Reel size (inches)	Tape width (mm)	Quantity per reel
ZXTN25100BFHTA	021	7	8	3,000

- Notes:
1. No purposely added lead. Fully EU Directive 2002/95/EC (RoHS) & 2011/65/EU (RoHS 2) compliant.
  2. See <http://www.diodes.com> for more information about Diodes Incorporated's definitions of Halogen- and Antimony-free, "Green" and Lead-free.
  3. Halogen- and Antimony-free "Green" products are defined as those which contain <900ppm bromine, <900ppm chlorine (<1500ppm total Br + Cl) and <1000ppm antimony compounds.
  4. For packaging details, go to our website at <http://www.diodes.com>.

**Marking Information**

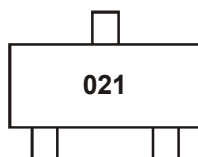

021 = Product Type Marking Code

**Maximum Ratings** (@T<sub>A</sub> = +25°C, unless otherwise specified.)

Characteristic	Symbol	Value	Unit
Collector-Base Voltage	V <sub>CB0</sub>	170	V
Collector-Emitter Voltage (Forward Blocking)	V <sub>CEX</sub>	170	V
Collector-Emitter Voltage	V <sub>CEO</sub>	100	V
Emitter-Base Voltage (Reverse Blocking)	V <sub>ECO</sub>	6	V
Emitter-Base Voltage	V <sub>EBO</sub>	7	V
Continuous Collector Current	I <sub>C</sub>	3	A
Peak Pulse Current (Note 5)	I <sub>CM</sub>	9	A

**Thermal Characteristics** (@T<sub>A</sub> = +25°C, unless otherwise specified.)

Characteristic	Symbol	Value	Unit
Power Dissipation Linear Derating Factor	(Note 5) P <sub>D</sub>	0.73 5.84	mW
Power Dissipation Linear Derating Factor	(Note 6) P <sub>D</sub>	1.05 8.4	mW
Power Dissipation Linear Derating Factor	(Note 7) P <sub>D</sub>	1.25 9.6	mW
Power Dissipation Linear Derating Factor	(Note 8) P <sub>D</sub>	1.81 14.5	mW
Thermal Resistance, Junction to Ambient	(Note 5) R <sub>θJA</sub>	171	°C/W
Thermal Resistance, Junction to Ambient	(Note 6) R <sub>θJA</sub>	119	°C/W
Thermal Resistance, Junction to Ambient	(Note 7) R <sub>θJA</sub>	100	°C/W
Thermal Resistance, Junction to Ambient	(Note 8) R <sub>θJA</sub>	69	°C/W
Thermal Resistance, Junction to Leads	(Note 9) R <sub>θJL</sub>	74.96	°C/W
Operating and Storage Temperature Range	T <sub>J</sub> , T <sub>STG</sub>	-55 to +150	°C

**ESD Ratings** (Note 10)

Characteristic	Symbol	Value	Unit	JEDEC Class
Electrostatic Discharge - Human Body Model	ESD HBM	≥ 8,000	V	3B
Electrostatic Discharge - Machine Model	ESD MM	≥ 400	V	C

- Notes:
- For a device surface mounted on 15mm x 15mm x 1.6mm FR4 PCB with high coverage of single sided 1oz copper, in still air conditions; the device is measured when operating in a steady-state condition.
  - Same as note (5), except mounted on 25mm x 25mm x 1.6mm FR4 PCB with 2 oz copper.
  - Same as note (5), except mounted on 50mm x 50mm x 1.6mm FR4 PCB with 2 oz copper.
  - Same as note (7), except measured at t < 5secs.
  - Thermal resistance from junction to solder-point (at the end of collector lead).
  - Refer to JEDEC specification JESD22-A114 and JESD22-A115.

**Thermal Characteristics and Derating information**

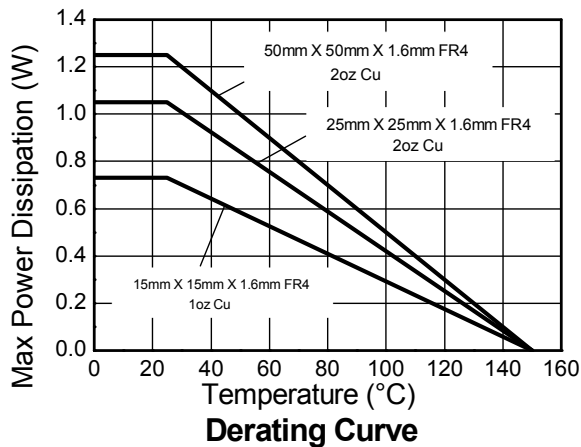
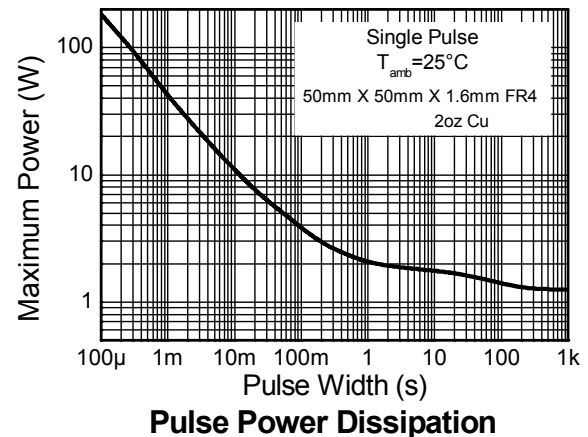
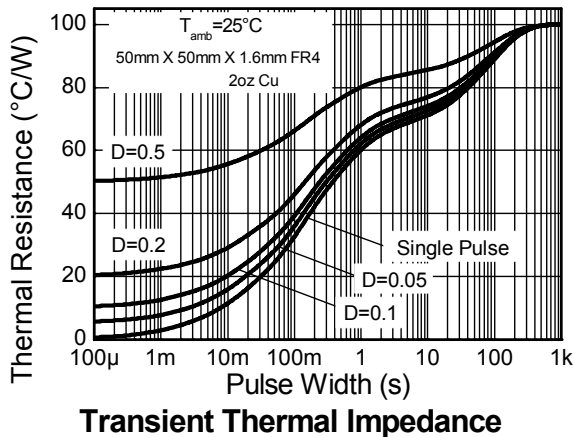
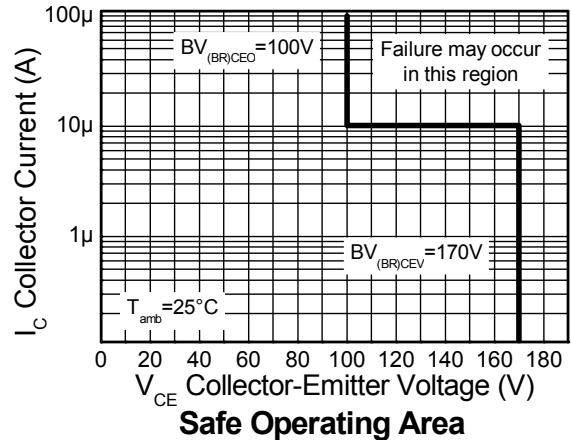
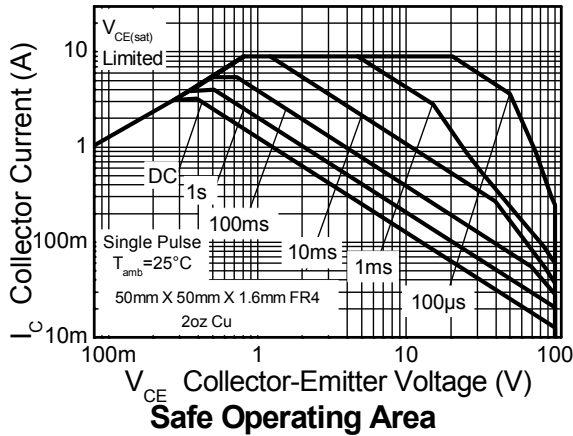

**Electrical Characteristics** (@T<sub>A</sub> = +25°C, unless otherwise specified.)

Characteristic	Symbol	Min	Typ	Max	Unit	Test Condition
Collector-Base Breakdown Voltage	BV <sub>CBO</sub>	170	220	-	V	I <sub>C</sub> = 100μA
Collector-Emitter Breakdown Voltage (Forward Blocking) (Note 11)	BV <sub>CEX</sub>	170	210	-	V	I <sub>C</sub> = 100μA, R <sub>BE</sub> < 1kΩ or -1V < V <sub>BE</sub> < 0.25V
Collector-Emitter Breakdown Voltage (Note 11)	BV <sub>CEO</sub>	100	120	-	V	I <sub>C</sub> = 1mA
Emitter-Collector Breakdown Voltage (Reverse Blocking) (Note 11)	BV <sub>ECX</sub>	6	7	-	V	I <sub>E</sub> = 100μA, R <sub>BC</sub> < 1kΩ or 0.25V > V <sub>BC</sub> > -0.25V
Emitter-Collector Breakdown Voltage	BV <sub>ECO</sub>	6	8.4	-	V	I <sub>E</sub> = 100μA
Emitter-Base Breakdown Voltage	BV <sub>EBO</sub>	7	8	-	V	I <sub>E</sub> = 100μA
Collector Cut-off Current	I <sub>CBO</sub>	-	<1	50 20	nA	V <sub>CB</sub> = 136V V <sub>CB</sub> = 136V, T <sub>A</sub> = +100°C
Collector Emitter Cut-off Current	I <sub>CEX</sub>	-	-	100	nA	V <sub>CE</sub> = 136V, R <sub>BE</sub> < 1kΩ or -1V < V <sub>BE</sub> < 0.25V
Emitter Cut-off Current	I <sub>EBO</sub>	-	<1	50	nA	V <sub>EB</sub> = 5.6V
Static Forward Current Transfer Ratio (Note 11)	h <sub>FE</sub>	100 50 -	200 85 20	300 -	-	I <sub>C</sub> = 10mA, V <sub>CE</sub> = 2V I <sub>C</sub> = 1A, V <sub>CE</sub> = 2V I <sub>C</sub> = 3A, V <sub>CE</sub> = 2V
Collector-Emitter Saturation Voltage (Note 11)	V <sub>CE(sat)</sub>	- - - -	40 100 70 200	55 135 80 250	mV	I <sub>C</sub> = 0.5A, I <sub>B</sub> = 50mA I <sub>C</sub> = 0.5A, I <sub>B</sub> = 10mA I <sub>C</sub> = 1A, I <sub>B</sub> = 100mA I <sub>C</sub> = 3A, I <sub>B</sub> = 300mA
Base-Emitter Saturation Voltage (Note 11)	V <sub>BE(sat)</sub>	-	940	1050	mV	I <sub>C</sub> = 3A, I <sub>B</sub> = 300mA
Base-Emitter Saturation Voltage (Note 11)	V <sub>BE(on)</sub>	-	890	1000	mV	I <sub>C</sub> = 3A, V <sub>CE</sub> = 2V
Transition Frequency	f <sub>T</sub>	-	160	-	MHz	I <sub>C</sub> = 100mA, V <sub>CE</sub> = 5V, f = 100MHz
Collector Output Capacitance	C <sub>obo</sub>	-	9.4	20	pF	V <sub>CB</sub> = 10V, f = 1MHz
Delay Time	t <sub>(d)</sub>	-	16	-	ns	V <sub>CC</sub> = 10V, I <sub>C</sub> = 0.5A, I <sub>B1</sub> = -I <sub>B2</sub> = 50mA
Rise Time	t <sub>(r)</sub>	-	55	-	ns	
Storage Time	t <sub>(s)</sub>	-	677	-	ns	
Fall Time	t <sub>(f)</sub>	-	95	-	ns	

Notes: 11. Measured under pulsed conditions. Pulse width ≤ 300μs. Duty cycle ≤ 2%

**Typical Electrical Characteristics** (@ $T_A = +25^\circ\text{C}$ , unless otherwise specified.)

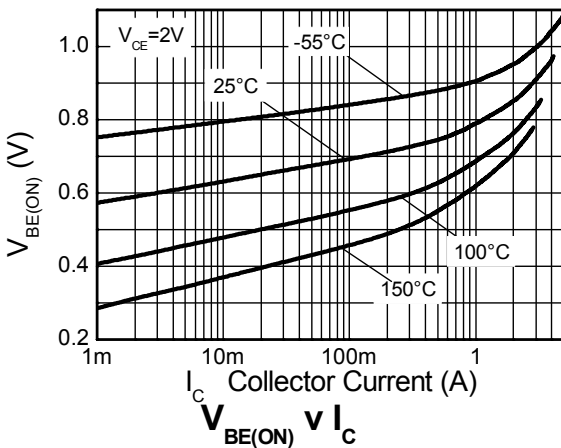
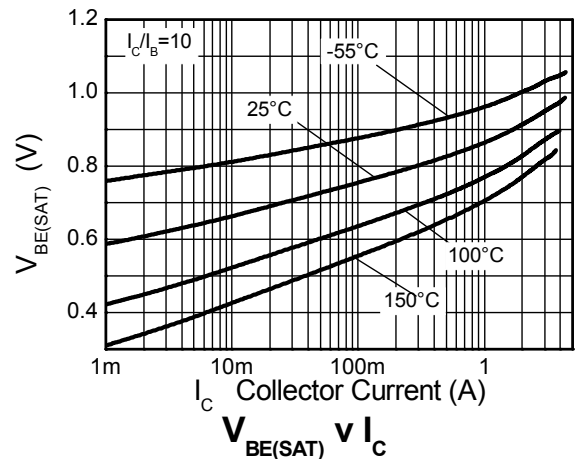
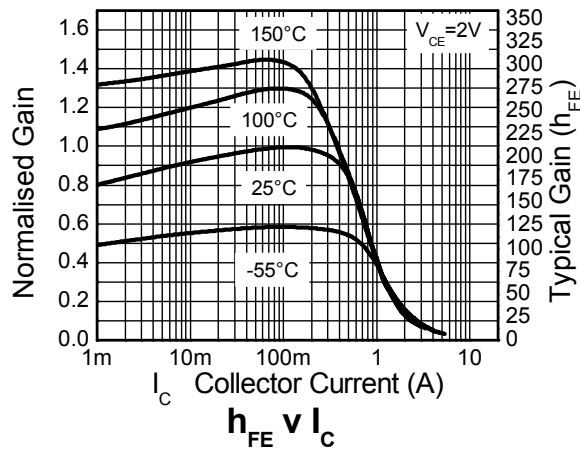
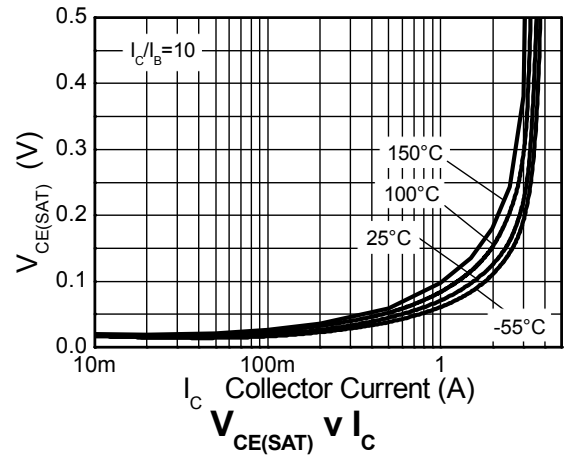
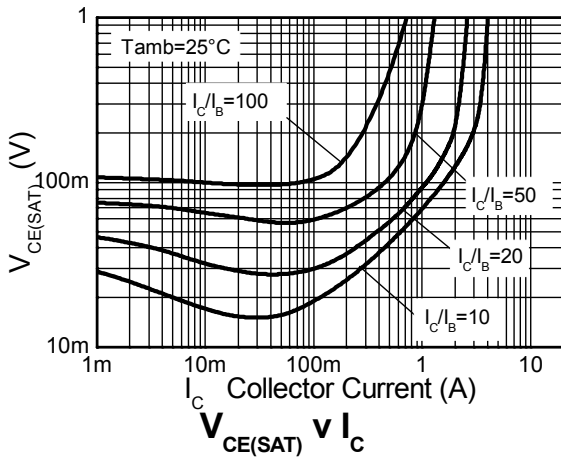

## Package Outline Dimensions

Please see AP02002 at <http://www.diodes.com/datasheets/ap02002.pdf> for latest version.

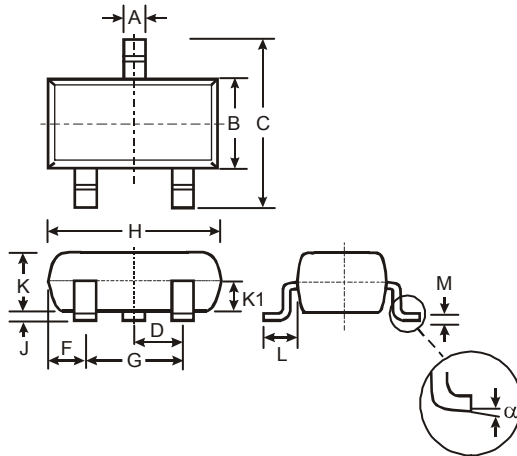

SOT23			
Dim	Min	Max	Typ
A	0.37	0.51	0.40
B	1.20	1.40	1.30
C	2.30	2.50	2.40
D	0.89	1.03	0.915
F	0.45	0.60	0.535
G	1.78	2.05	1.83
H	2.80	3.00	2.90
J	0.013	0.10	0.05
K	0.903	1.10	1.00
K1	-	-	0.400
L	0.45	0.61	0.55
M	0.085	0.18	0.11
α	0°	8°	-

All Dimensions in mm

## Suggested Pad Layout

Please see AP02001 at <http://www.diodes.com/datasheets/ap02001.pdf> for the latest version.

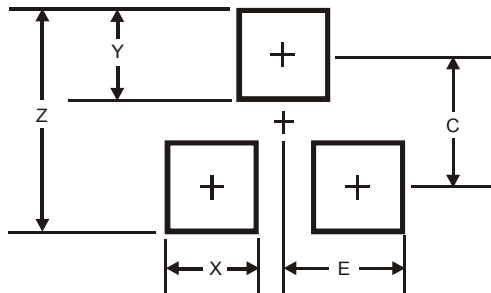

Dimensions	Value (in mm)
Z	2.9
X	0.8
Y	0.9
C	2.0
E	1.35

#### IMPORTANT NOTICE

DIODES INCORPORATED MAKES NO WARRANTY OF ANY KIND, EXPRESS OR IMPLIED, WITH REGARDS TO THIS DOCUMENT, INCLUDING, BUT NOT LIMITED TO, THE IMPLIED WARRANTIES OF MERCHANTABILITY AND FITNESS FOR A PARTICULAR PURPOSE (AND THEIR EQUIVALENTS UNDER THE LAWS OF ANY JURISDICTION).

Diodes Incorporated and its subsidiaries reserve the right to make modifications, enhancements, improvements, corrections or other changes without further notice to this document and any product described herein. Diodes Incorporated does not assume any liability arising out of the application or use of this document or any product described herein; neither does Diodes Incorporated convey any license under its patent or trademark rights, nor the rights of others. Any Customer or user of this document or products described herein in such applications shall assume all risks of such use and will agree to hold Diodes Incorporated and all the companies whose products are represented on Diodes Incorporated website, harmless against all damages.

Diodes Incorporated does not warrant or accept any liability whatsoever in respect of any products purchased through unauthorized sales channel. Should Customers purchase or use Diodes Incorporated products for any unintended or unauthorized application, Customers shall indemnify and hold Diodes Incorporated and its representatives harmless against all claims, damages, expenses, and attorney fees arising out of, directly or indirectly, any claim of personal injury or death associated with such unintended or unauthorized application.

Products described herein may be covered by one or more United States, international or foreign patents pending. Product names and markings noted herein may also be covered by one or more United States, international or foreign trademarks.

This document is written in English but may be translated into multiple languages for reference. Only the English version of this document is the final and determinative format released by Diodes Incorporated.

#### LIFE SUPPORT

Diodes Incorporated products are specifically not authorized for use as critical components in life support devices or systems without the express written approval of the Chief Executive Officer of Diodes Incorporated. As used herein:

A. Life support devices or systems are devices or systems which:

1. are intended to implant into the body, or
2. support or sustain life and whose failure to perform when properly used in accordance with instructions for use provided in the labeling can be reasonably expected to result in significant injury to the user.

B. A critical component is any component in a life support device or system whose failure to perform can be reasonably expected to cause the failure of the life support device or to affect its safety or effectiveness.

Customers represent that they have all necessary expertise in the safety and regulatory ramifications of their life support devices or systems, and acknowledge and agree that they are solely responsible for all legal, regulatory and safety-related requirements concerning their products and any use of Diodes Incorporated products in such safety-critical, life support devices or systems, notwithstanding any devices- or systems-related information or support that may be provided by Diodes Incorporated. Further, Customers must fully indemnify Diodes Incorporated and its representatives against any damages arising out of the use of Diodes Incorporated products in such safety-critical, life support devices or systems.

Copyright © 2012, Diodes Incorporated

[www.diodes.com](http://www.diodes.com)