



Micro Commercial Components



Micro Commercial Components  
20736 Marilla Street Chatsworth  
CA 91311  
Phone: (818) 701-4933  
Fax: (818) 701-4939

# MMSS8050-L MMSS8050-H

## Features

- SOT-23 Plastic-Encapsulate Transistors
- Capable of 0.3Watts( $T_{amb}=25^{\circ}C$ ) of Power Dissipation.
- Collector-current 1.5A
- Collector-base Voltage 40V
- Operating and storage junction temperature range:  $-55^{\circ}C$  to  $+150^{\circ}C$
- Marking : Y1
- Case Material: Molded Plastic. UL Flammability Classification Rating 94V-0 and MSL Rating 1
- Halogen free available upon request by adding suffix "-HF"

## NPN Silicon Plastic-Encapsulate Transistor

### Electrical Characteristics @ 25°C Unless Otherwise Specified

Symbol	Parameter	Min	Max	Units
<b>OFF CHARACTERISTICS</b>				
$V_{(BR)CBO}$	Collector-Base Breakdown Voltage ( $I_C=100\mu A$ , $I_E=0$ )	40	---	Vdc
$V_{(BR)CEO}$	Collector-Emitter Breakdown Voltage ( $I_C=0.1mA$ , $I_B=0$ )	25	---	Vdc
$V_{(BR)EBO}$	Emitter-Base Breakdown Voltage ( $I_E=100\mu A$ , $I_C=0$ )	5.0	---	Vdc
$I_{CBO}$	Collector Cutoff Current ( $V_{CB}=40Vdc$ , $I_E=0$ )	---	0.1	$\mu A$
$I_{CEO}$	Collector Cutoff Current ( $V_{CE}=20Vdc$ , $I_B=0$ )	---	0.1	$\mu A$
$I_{EBO}$	Emitter Cutoff Current ( $V_{EB}=5.0Vdc$ , $I_C=0$ )	---	0.1	$\mu A$

### ON CHARACTERISTICS

$h_{FE(1)}$	DC Current Gain ( $I_C=100mA$ , $V_{CE}=1.0Vdc$ )	120	350	---
$h_{FE(2)}$	DC Current Gain ( $I_C=800mA$ , $V_{CE}=1.0Vdc$ )	40	---	---
$V_{CE(sat)}$	Collector-Emitter Saturation Voltage ( $I_C=800mA$ , $I_B=80mA$ )	---	0.5	Vdc
$V_{BE(sat)}$	Base-Emitter Saturation Voltage ( $I_C=800mA$ , $I_B=80mA$ )	---	1.2	Vdc
$V_{EB}$	Base- Emitter Voltage ( $I_E=1.5A$ )	---	1.6	Vdc

### SMALL-SIGNAL CHARACTERISTICS

$f_T$	Transistor Frequency ( $I_C=50mA$ , $V_{CE}=10Vdc$ , $f=30MHz$ )	100	---	MHz
-------	---	-----	-----	-----

### CLASSIFICATION OF $h_{FE(1)}$

Rank	L	H
Range	120-200	200-350

### SOT-23

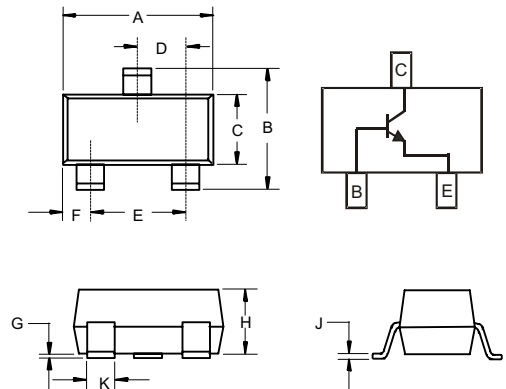

#### DIMENSIONS

DIM	INCHES		MM		NOTE
	MIN	MAX	MIN	MAX	
A	.110	.120	2.80	3.04	
B	.083	.104	2.10	2.64	
C	.047	.055	1.20	1.40	
D	.035	.041	.89	1.03	
E	.070	.081	1.78	2.05	
F	.018	.024	.45	.60	
G	.0005	.0039	.013	.100	
H	.035	.044	.89	1.12	
J	.003	.007	.085	.180	
K	.015	.020	.37	.51	

### Suggested Solder Pad Layout

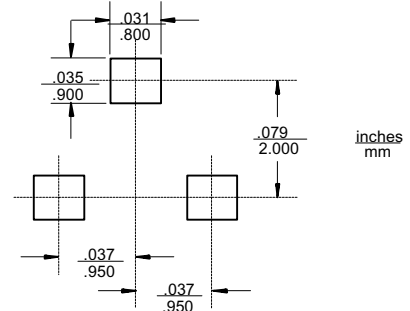

# MMSS8050



Micro Commercial Components

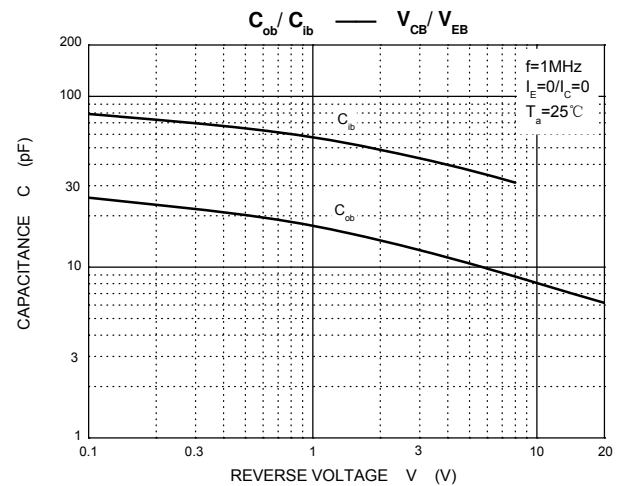
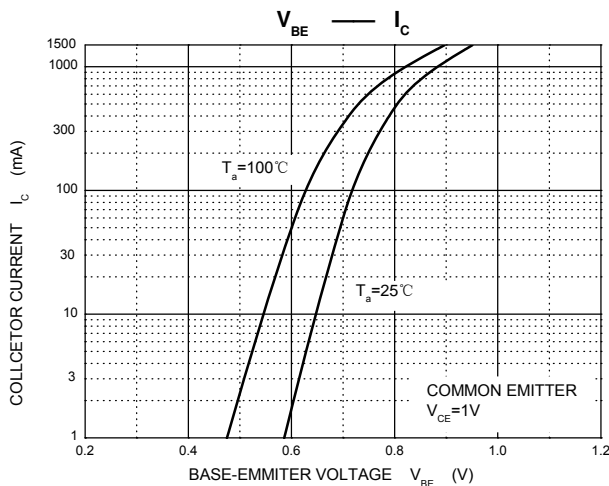
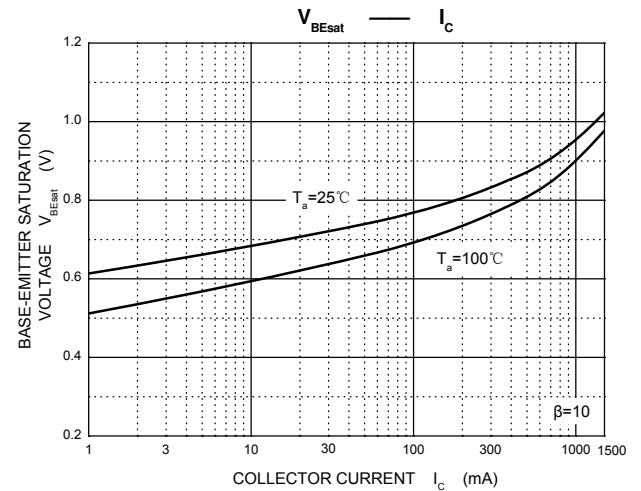
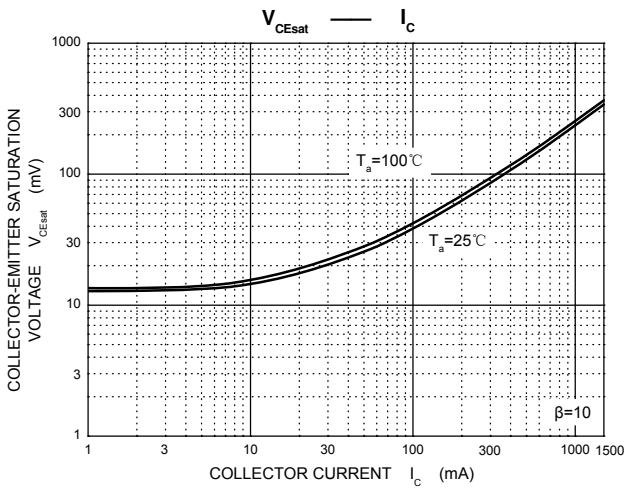
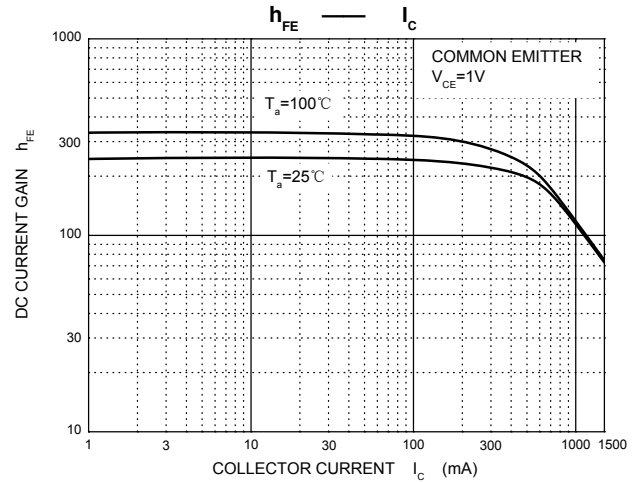
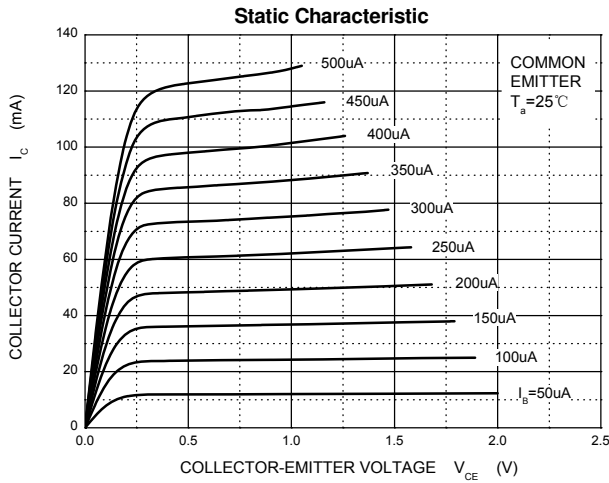



TM

Micro Commercial Components

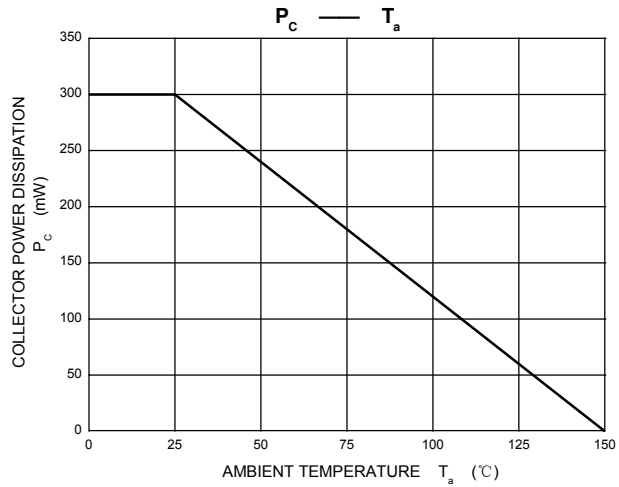
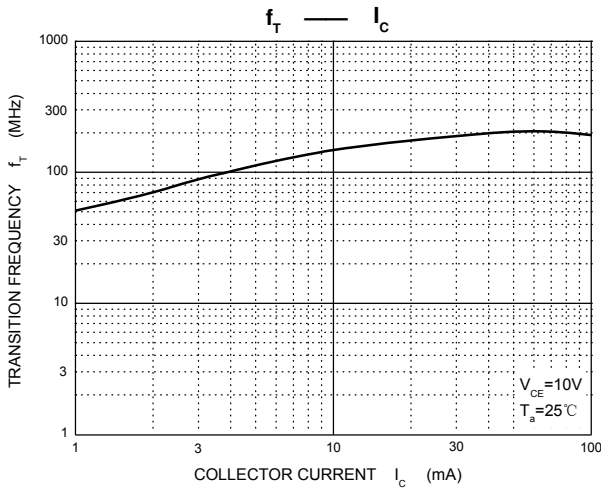

Ordering Information :

Device	Packing
Part Number-TP	Tape&Reel: 3 Kpcs/Reel

Note : Adding "-HF" suffix for halogen free, eg. Part Number-TP-HF

\*\*\*IMPORTANT NOTICE\*\*\*

**Micro Commercial Components Corp.** reserves the right to make changes without further notice to any product herein to make corrections, modifications, enhancements, improvements, or other changes. **Micro Commercial Components Corp.** does not assume any liability arising out of the application or use of any product described herein; neither does it convey any license under its patent rights, nor the rights of others. The user of products in such applications shall assume all risks of such use and will agree to hold **Micro Commercial Components Corp.** and all the companies whose products are represented on our website, harmless against all damages.

\*\*\*LIFE SUPPORT\*\*\*

MCC's products are not authorized for use as critical components in life support devices or systems without the express written approval of Micro Commercial Components Corporation.

\*\*\*CUSTOMER AWARENESS\*\*\*

Counterfeiting of semiconductor parts is a growing problem in the industry. Micro Commercial Components (MCC) is taking strong measures to protect ourselves and our customers from the proliferation of counterfeit parts. MCC strongly encourages customers to purchase MCC parts either directly from MCC or from Authorized MCC Distributors who are listed by country on our web page cited below. Products customers buy either from MCC directly or from Authorized MCC Distributors are genuine parts, have full traceability, meet MCC's quality standards for handling and storage. **MCC will not provide any warranty coverage or other assistance for parts bought from Unauthorized Sources.** MCC is committed to combat this global problem and encourage our customers to do their part in stopping this practice by buying direct or from authorized distributors.

[www.mccsemi.com](http://www.mccsemi.com)