

N-Channel Enhancement Mode Power MOSFET

MTN2572E3

BV_{DSS}	150V
I_D	44A
$R_{DS(ON)}$	33m Ω (typ.)

Features

- Low Gate Charge
- Simple Drive Requirement
- Repetitive Avalanche Rated
- Fast Switching Characteristic
- Pb-free lead plating and RoHS compliant package

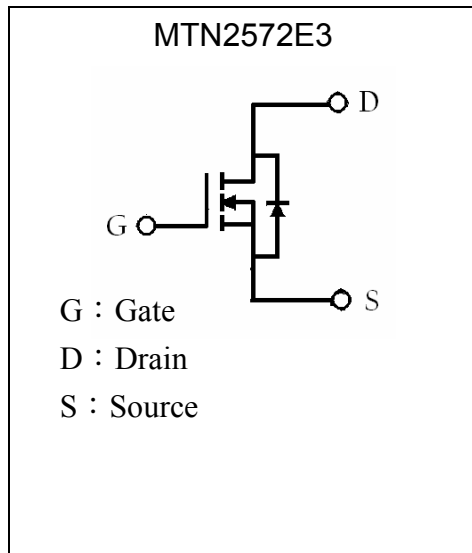
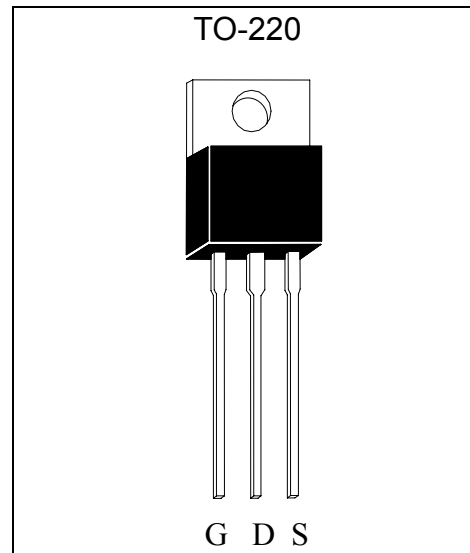
Symbol

Outline

Absolute Maximum Ratings ($T_C=25^\circ\text{C}$, unless otherwise noted)

Parameter	Symbol	Limits	Unit
Drain-Source Voltage	V_{DS}	150	V
Gate-Source Voltage	V_{GS}	± 30	
Continuous Drain Current @ $V_{GS}=10\text{V}$, $T_C=25^\circ\text{C}$	I_D	44	A
Continuous Drain Current @ $V_{GS}=10\text{V}$, $T_C=100^\circ\text{C}$	I_D	31	
Pulsed Drain Current (Note 1)	I_{DM}	120	
Avalanche Current	I_{AS}	18	
Avalanche Energy @ $L=0.1\text{mH}$, $I_D=20\text{A}$, $R_G=25\Omega$	E_{AS}	20	mJ
Repetitive Avalanche Energy @ $L=0.05\text{mH}$ (Note 2)	E_{AR}	10	
Total Power Dissipation ($T_C=25^\circ\text{C}$)	P_D	156	W
Total Power Dissipation ($T_C=100^\circ\text{C}$)		78	
Operating Junction and Storage Temperature	T_j, T_{stg}	-55~+175	$^\circ\text{C}$



Note : 1. Pulse width limited by maximum junction temperature
 2. Duty cycle $\leq 1\%$

Thermal Data

Parameter	Symbol	Value	Unit
Thermal Resistance, Junction-to-case, max	$R_{th,j-c}$	0.96	°C/W
Thermal Resistance, Junction-to-ambient, max	$R_{th,j-a}$	62.5	

Characteristics (Tc=25°C, unless otherwise specified)

Symbol	Min.	Typ.	Max.	Unit	Test Conditions
Static					
BV_{DSS}	150	-	-	V	$V_{GS}=0V, I_D=250\mu A$
$\Delta BV_{DSS}/\Delta T_j$	-	0.1	-	V/°C	Reference to 25°C, $I_D=1mA$
$V_{GS(th)}$	1.5	2.8	4.0	V	$V_{DS} = V_{GS}, I_D=250\mu A$
G_{FS}	-	34	-	S	$V_{DS} = 5V, I_D=20A$
I_{GSS}	-	-	± 100	nA	$V_{GS}=\pm 30$
I_{DSS}	-	-	1	μA	$V_{DS} = 120V, V_{GS} = 0V$
	-	-	25		$V_{DS} = 100V, V_{GS} = 0V, T_j=125^\circ C$
$*R_{DS(ON)}$	-	33	50	mΩ	$V_{GS} = 10V, I_D=20A$
Dynamic					
$*Q_g$	-	30	-	nC	$I_D=20A, V_{DS}=80V, V_{GS}=10V$
$*Q_{gs}$	-	10	-		
$*Q_{gd}$	-	8	-		
$*t_{d(ON)}$	-	13	-	ns	$V_{DS}=75V, I_D=1A, V_{GS}=10V, R_G=6\Omega$
$*t_r$	-	12	-		
$*t_{d(OFF)}$	-	47	-		
$*t_f$	-	20	-		
C_{iss}	-	2249	-	pF	$V_{GS}=0V, V_{DS}=25V, f=1MHz$
C_{oss}	-	225	-		
C_{rss}	-	118	-		
R_g	-	2	-	Ω	$V_{GS}=15mV, V_{DS}=0V, f=1MHz$
Source-Drain Diode					
$*I_S$	-	-	36	A	
$*I_{SM}$	-	-	120		
$*V_{SD}$	-	-	1.3	V	$I_F=I_S, V_{GS}=0V$
$*t_{rr}$	-	120	-	ns	$I_F=25A, V_{GS}=0, dI_F/dt=100A/\mu s$
$*Q_{rr}$	-	380	-	nC	

*Pulse Test : Pulse Width $\leq 300\mu s$, Duty Cycles $\leq 2\%$

Ordering Information

Device	Package	Shipping
MTN2572E3-0-UB-S	TO-220 (Pb-free lead plating and RoHS compliant package)	50 pcs/tube, 20 tubes/box, 4 boxes / carton

Typical Characteristics

Typical Output Characteristics

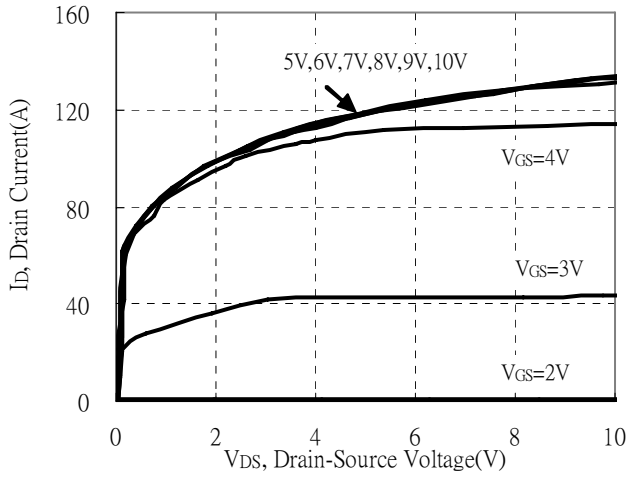

Brekdown Voltage vs Ambient Temperature

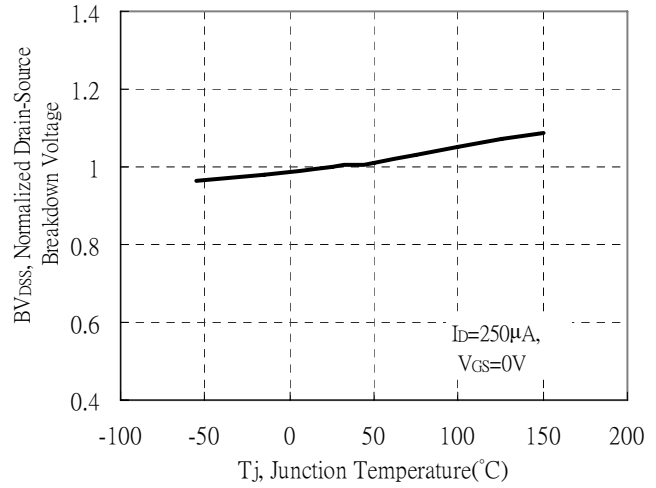

Static Drain-Source On-State resistance vs Drain Current

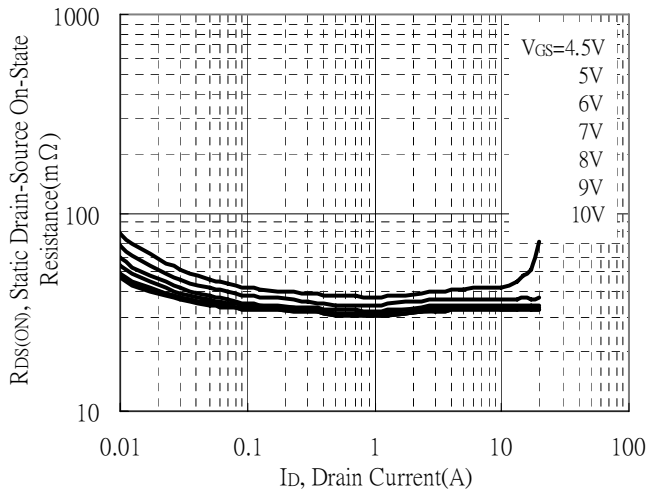

Reverse Drain Current vs Source-Drain Voltage

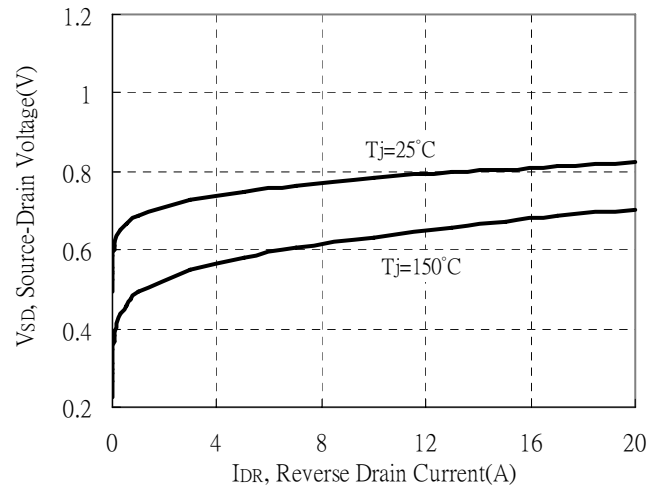

Static Drain-Source On-State Resistance vs Gate-Source Voltage

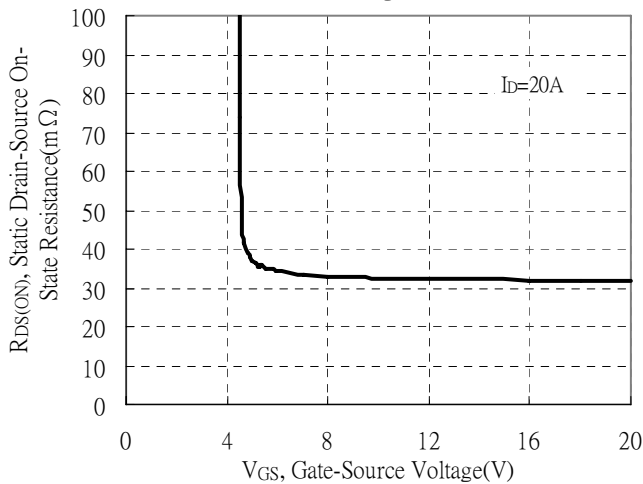

Drain-Source On-State Resistance vs Junction Temperature

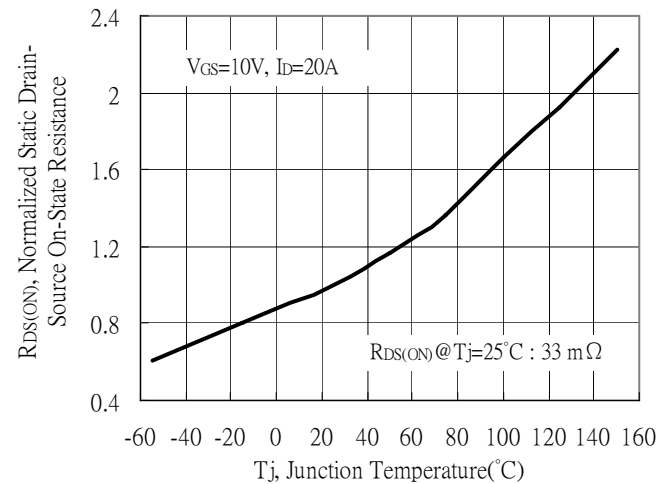



Typical Characteristics(Cont.)

Capacitance vs Drain-to-Source Voltage

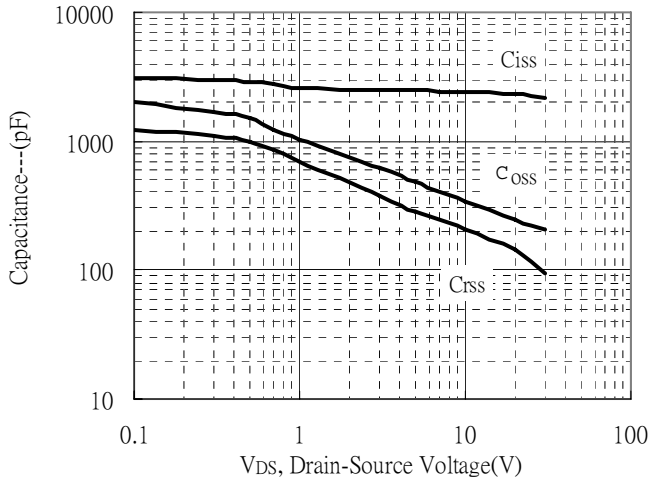

Normalized Threshold Voltage vs Junction Temperature

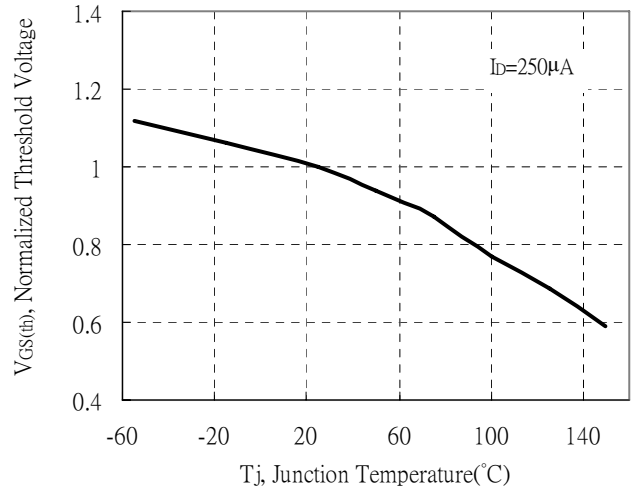

Forward Transfer Admittance vs Drain Current

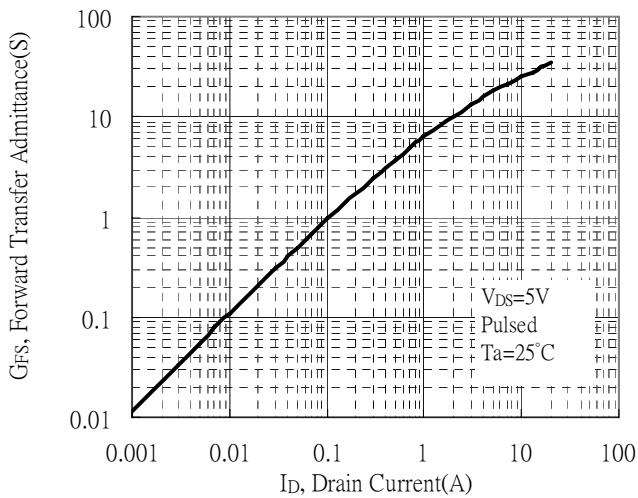

Gate Charge Characteristics

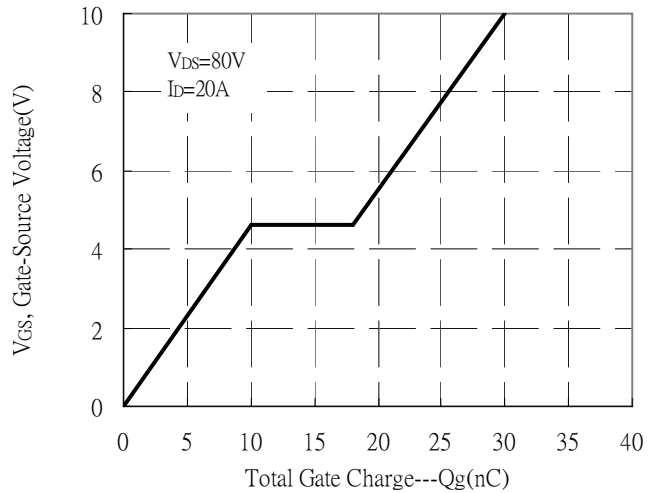

Maximum Safe Operating Area

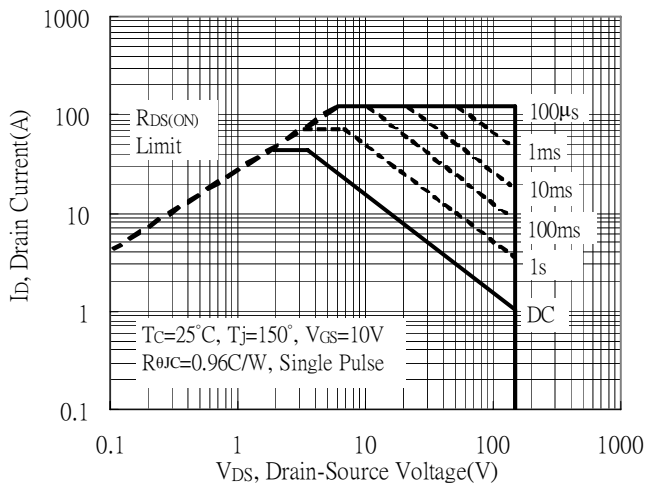

Typical Transfer Characteristics

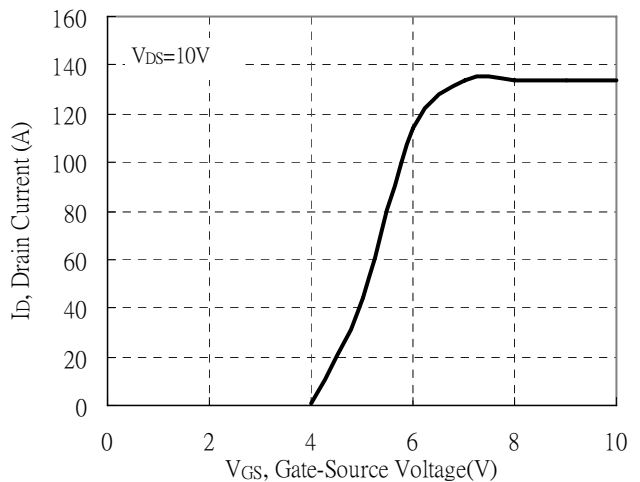

Typical Characteristics(Cont.)

Maximum Drain Current vs Case Temperature

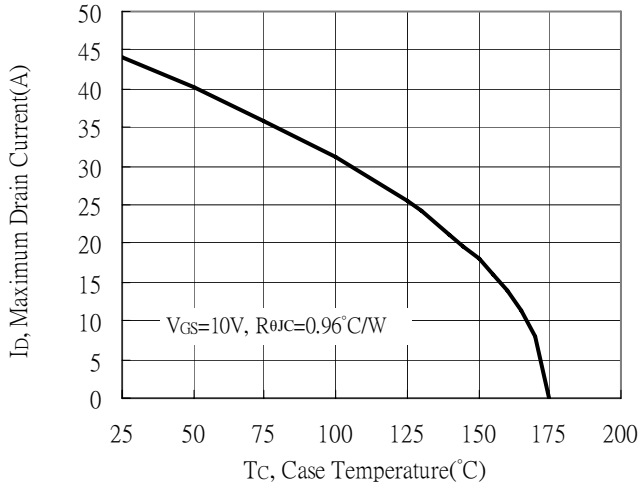

Transient Thermal Response Curves

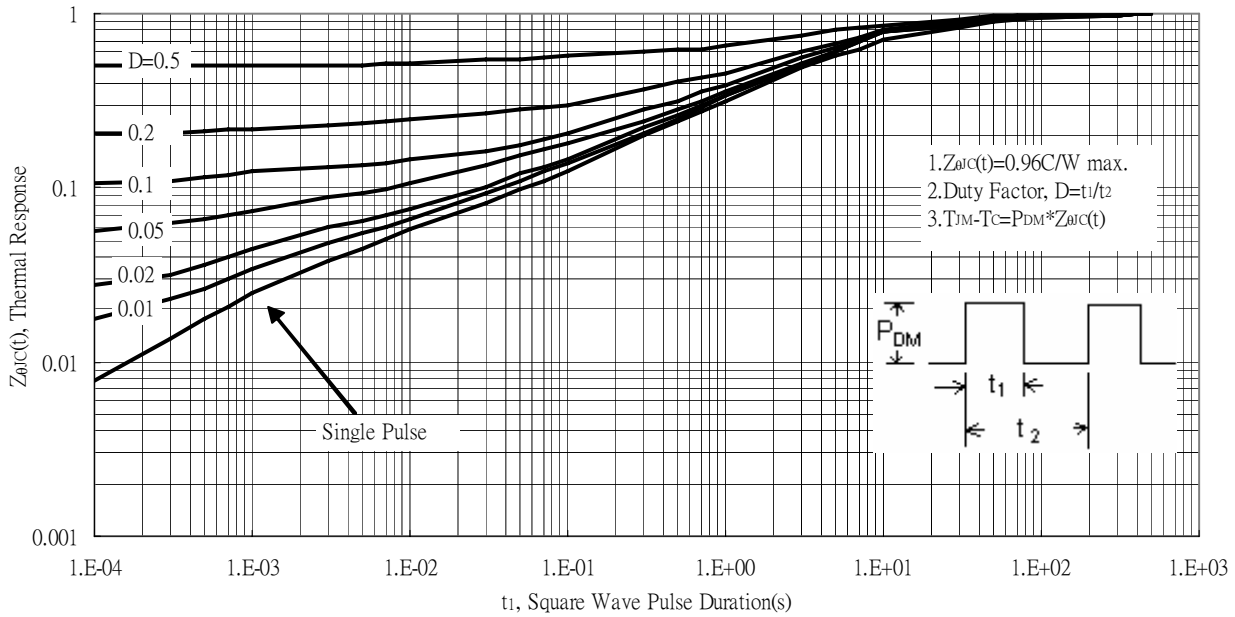

Recommended wave soldering condition

Product	Peak Temperature	Soldering Time
Pb-free devices	260 +0/-5 °C	5 +1/-1 seconds

Recommended temperature profile for IR reflow

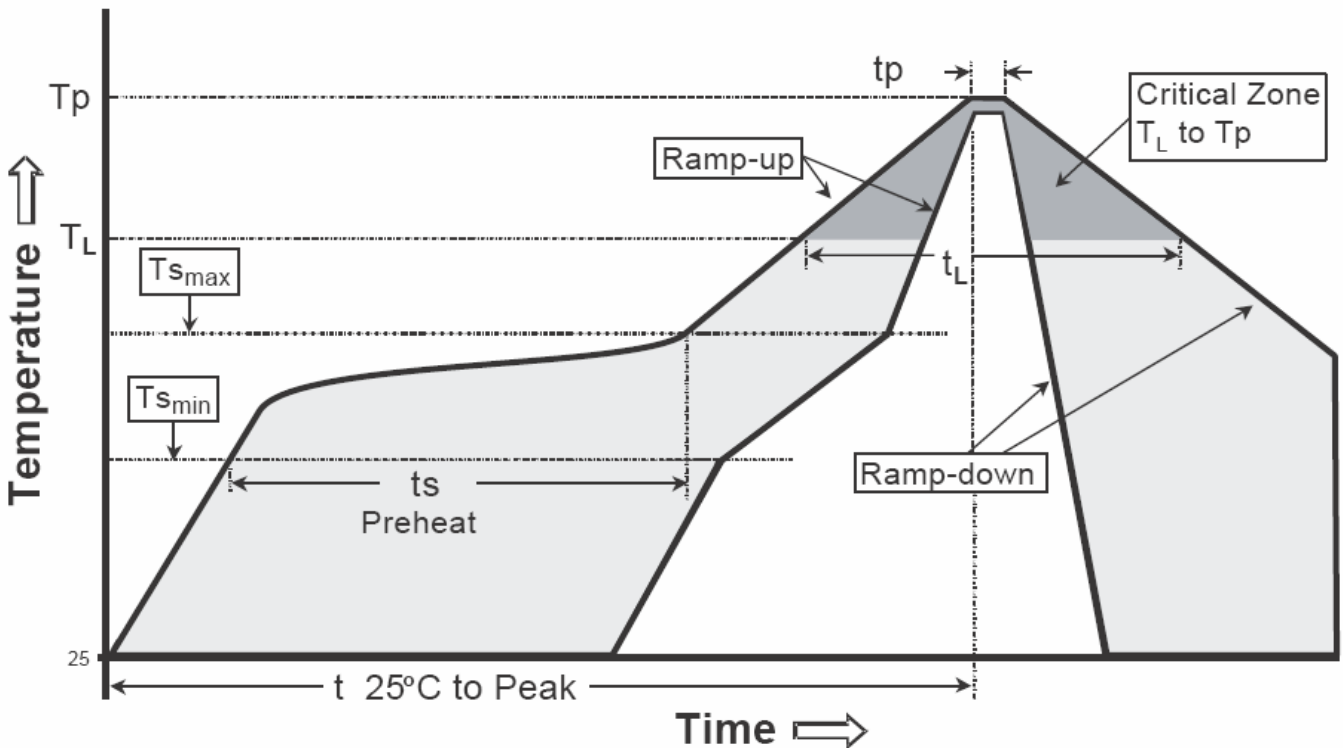

Profile feature	Sn-Pb eutectic Assembly	Pb-free Assembly
Average ramp-up rate (T _{smax} to T _p)	3°C/second max.	3°C/second max.
Preheat		
-Temperature Min(T _{s min})	100°C	150°C
-Temperature Max(T _{s max})	150°C	200°C
-Time(t _{s min} to t _{s max})	60-120 seconds	60-180 seconds
Time maintained above:		
-Temperature (T _L)	183°C	217°C
- Time (t _L)	60-150 seconds	60-150 seconds
Peak Temperature(T _P)	240 +0/-5 °C	260 +0/-5 °C
Time within 5°C of actual peak temperature(tp)	10-30 seconds	20-40 seconds
Ramp down rate	6°C/second max.	6°C/second max.
Time 25 °C to peak temperature	6 minutes max.	8 minutes max.

Note : All temperatures refer to topside of the package, measured on the package body surface.

TO-220 Dimension

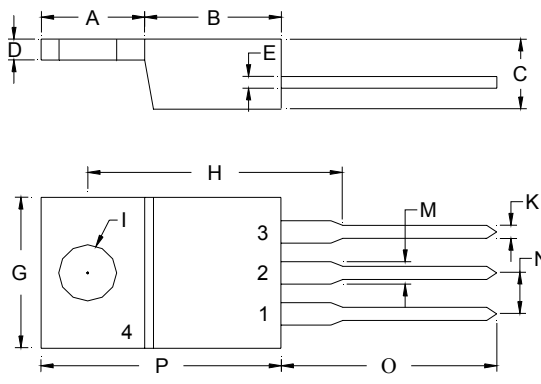

Marking:

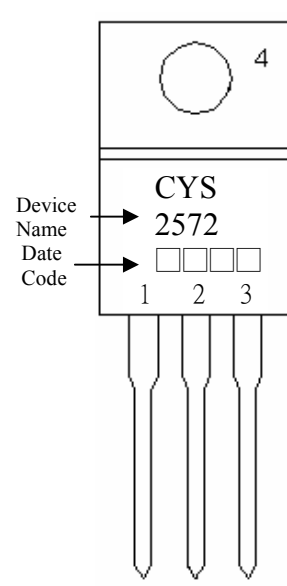

3-Lead TO-220 Plastic Package
 CYStek Package Code: E3

Style: Pin 1.Gate 2.Drain 3.Source
 4.Drain

*: Typical

DIM	Inches		Millimeters		DIM	Inches		Millimeters	
	Min.	Max.	Min.	Max.		Min.	Max.	Min.	Max.
A	0.2441	0.2598	6.20	6.60	I	-	*0.1508	-	*3.83
B	0.3386	0.3543	8.60	9.00	K	0.0299	0.0394	0.76	1.00
C	0.1732	0.1890	4.40	4.80	M	0.0461	0.0579	1.17	1.47
D	0.0492	0.0571	1.25	1.45	N	-	*0.1000	-	*2.54
E	0.0142	0.0197	0.36	0.50	O	0.5217	0.5610	13.25	14.25
G	0.3858	0.4094	9.80	10.40	P	0.5787	0.6024	14.70	15.30
H	-	*0.6398	-	*16.25					

Notes: 1.Controlling dimension: millimeters.
 2.Maximum lead thickness includes lead finish thickness, and minimum lead thickness is the minimum thickness of base material.
 3.If there is any question with packing specification or packing method, please contact your local CYStek sales office.

Material:

- Lead: Pure tin plated.
- Mold Compound: Epoxy resin family, flammability solid burning class: UL94V-0.

Important Notice:

- All rights are reserved. Reproduction in whole or in part is prohibited without the prior written approval of CYStek.
- CYStek reserves the right to make changes to its products without notice.
- CYStek **semiconductor products are not warranted to be suitable for use in Life-Support Applications, or systems.**
- CYStek assumes no liability for any consequence of customer product design, infringement of patents, or application assistance.